

BELLSOUTH  
 TELECOMMUNICATIONS  
 TENNESSEE  
 ISSUED: December 9, 2022  
 BY: Joelle Phillips, President - Tennessee  
 Nashville, Tennessee

ACCESS SERVICES TARIFF

Thirteenth Revised Page 1  
 Cancels Twelfth Revised Page 1

EFFECTIVE: January 1, 2023

**E7. SPECIAL ACCESS (A.K.A. BELLSOUTH SPA) SERVICE**

CONTENTS

<b>E7.1</b>	<b>General</b>		1
E7.1.1	Channel Types		1
E7.1.2	Rate Categories		2
E7.1.3	Service Configurations	3.1.1	
E7.1.4	Alternate Use		6
E7.1.5	Special Facilities Routing		6
E7.1.6	Design Layout Report		6
E7.1.7	Acceptance Testing		6
E7.1.8	Ordering Options And Conditions		6
<b>E7.2</b>	<b>Service Descriptions</b>		7
E7.2.1	Reserved for Future Use		8
E7.2.2	Reserved for Future Use		9
E7.2.3	Voice Grade (a.k.a. BellSouth SPA DS0 VG) Service		10
E7.2.4	<b>Reserved For Future Use</b>		16
E7.2.5	Reserved For Future Use		17
E7.2.6	Reserved For Future Use		18
E7.2.7	Digital Data Access (a.k.a. BellSouth SPA DS0 Digital Data) Service		18
E7.2.8	High Capacity (a.k.a. BellSouth SPA High Capacity) Service		20
E7.2.9	Reserved For Future Use		22.1
E7.2.10	Reserved For Future Use		22.1
E7.2.11	Reserved For Future Use		22.1
E7.2.12	SMARTPath Service (a.k.a. BellSouth SPA Dedicated Ring)		22.1
E7.2.13	Reserved For Future Use		22.1.2
E7.2.14	Reserved For Future Use		22.1.2
E7.2.15	Derived Data Channel (a.k.a. BellSouth SPA Derived Data Channel) Service		22.3
E7.2.16	SMARTRing service (a.k.a. BellSouth Dedicated Ring)		22.3
E7.2.17	Reserved For Future Use		22.5.0.1
E7.2.18	BellSouth Metro Ethernet Service		22.5.1
<b>E7.3</b>	<b>Channel Interface And Network Channel Codes</b>		23
E7.3.1	Glossary Of Channel Interface Codes And Options		23
E7.3.2	Impedance		27
E7.3.3	Digital Hierarchy Channel Interface Codes (4DS)		27
E7.3.4	Service Designator/Network Channel Code Conversion Table		27
E7.3.5	Reserved For Future Use		28

BELLSOUTH  
TELECOMMUNICATIONS  
TENNESSEE

ACCESS SERVICES TARIFF

Fifteenth Revised Page 2  
Cancels Fourteenth Revised Page 2

ISSUED: October 10, 2014  
BY: Joelle Phillips, President - Tennessee  
Nashville, Tennessee

EFFECTIVE: October 31, 2014

## E7. SPECIAL ACCESS (A.K.A. BELLSOUTH SPA) SERVICE

### CONTENTS

<b>E7.4</b>	<b>Rate Regulations</b>	29	
E7.4.1	Types Of Rates And Charges	29	
E7.4.2	Surcharge For Special Access (a.k.a. BellSouth SPA) Service	31	
E7.4.3	Message Station Equipment Recovery charge	33	
E7.4.4	Minimum Periods	33	
E7.4.5	Moves	33	
E7.4.6	Mileage Measurement	34	
E7.4.7	Facility Hubs	35	
E7.4.8	Shared Use Analog And Digital High Capacity Services	36	
E7.4.9	Reserved For Future Use	36.0.0.1	
E7.4.10	Reserved For Future Use	36.0.0.1	
E7.4.11	Reserved For Future Use	36.0.0.1	
E7.4.12	FlexServ Service	36.0.0.1	
E7.4.13	Derived Data Channel (a.k.a. BellSouth SPA Derived Data Channel) Service (DDCS)	36.4	
E7.4.14	SMARTRing service (a.k.a. BellSouth Dedicated Ring)	36.4	
E7.4.15	Reserved For Future Use	36.7	
E7.4.16	Reserved For Future Use	36.7	(T)
E7.4.17	SMARTPath Service (a.k.a. BellSouth SPA Shared Ring)	36.8	
E7.4.18	Reserved For Future Use	36.9	
E7.4.19	Reserved For Future Use	36.9	
E7.4.20	Reserved For Future Use	36.9	
E7.4.21	Reserved For Future Use	36.9	
E7.4.22	Reserved For Future Use	36.9	
E7.4.23	Reserved For Future Use	36.9	
E7.4.24	Reserved For Future Use	36.9	
E7.4.25	Reserved For Future Use	36.9	
E7.4.26	Reserved For Future Use	36.9	
E7.4.27	Reserved For Future Use	36.9	
E7.4.28	Reserved For Future Use	36.9	
E7.4.29	Reserved For Future Use	36.9	
E7.4.30	Reserved For Future Use	36.9	
E7.4.31	Reserved For Future Use	36.9	
E7.4.32	BellSouth Metro Ethernet Service	36.10	

BELLSOUTH  
TELECOMMUNICATIONS  
TENNESSEE

ACCESS SERVICES TARIFF

Ninth Revised Page 3  
Cancels Eighth Revised Page 3

ISSUED: December 9, 2022  
BY: Joelle Phillips, President - Tennessee  
Nashville, Tennessee

EFFECTIVE: January 1, 2023

## E7. SPECIAL ACCESS (A.K.A. BELLSOUTH SPA) SERVICE

### CONTENTS

<b>E7.5</b>	<b>Rates And Charges</b>	36.16	
E7.5.1	Reserved for Future Use	36.16	
E7.5.2	Reserved for Future Use	37	
E7.5.3	Voice Grade (a.k.a. BellSouth SPA DS0 VG) Service	38	
E7.5.4	<b>Reserved For Future Use</b>	43	(T)
E7.5.5	Reserved For Future Use	44	
E7.5.6	Reserved For Future Use	44	
E7.5.7	Digital Data Access (a.k.a. BellSouth SPA DS0 Digital Data) Service	45	
E7.5.8	High Capacity (a.k.a. BellSouth SPA High Capacity) Service	48	
E7.5.9	Message Station Equipment Recovery Charge	52	
E7.5.10	Special Access (a.k.a. BellSouth SPA) Surcharge	52	
E7.5.11	Reserved for Future Use	52	
E7.5.12	Reserved for Future Use	52	
E7.5.13	Transfer of Service	52	
E7.5.14	(DELETED)	52	
E7.5.15	Derived Data Channel (a.k.a. BellSouth SPA Derived Data Channel) Service	52.0.2	
E7.5.16	FlexServ Service (a.k.a. BellSouth SPA Customer Reconfiguration)	52.0.2	
E7.5.17	SMARTPath Service (a.k.a. BellSouth SPA Shared Ring)	52.0.3	
E7.5.18	SMARTRing service (a.k.a. BellSouth Dedicated Ring)	52.0.4	
E7.5.19	Reserved For Future Use	52.0.7	
E7.5.20	Reserved For Future Use	52.0.8	
E7.5.21	Reserved For Future Use	52.0.8	
E7.5.22	BellSouth Metro Ethernet Service	52.0.8	
<b>E7.6</b>	<b>Reserved For Future Use</b>	52.1	
<b>E7.7</b>	<b>Custom Network (a.k.a. BellSouth Custom Network) Service</b>	52.1	
E7.7.1	General	52.1	
E7.7.2	Custom Network Service Arrangement I	52.1	
E7.7.3	Custom Network Service Arrangement II	55	

BELLSOUTH  
TELECOMMUNICATIONS  
TENNESSEE

ACCESS SERVICES TARIFF

Fifteenth Revised Page 1  
Cancels Fourteenth Revised Page 1

ISSUED: December 9, 2022  
BY: Joelle Phillips, President - Tennessee  
Nashville, Tennessee

EFFECTIVE: January 1, 2023

## E7. SPECIAL ACCESS (A.K.A. BELLSOUTH SPA) SERVICE

### E7.1 General

Special Access (a.k.a. BellSouth SPA) service provides a transmission path to connect customer designated premises<sup>1</sup>, either directly or through a Company hub where bridging or channelization functions are performed. Special Access (a.k.a. BellSouth SPA) service<sup>2</sup> includes all exchange access not utilizing Company end office switches.

The connections provided by Special Access (a.k.a. BellSouth SPA) service can be either analog or digital. Analog connections are differentiated by spectrum and bandwidth. Digital connections are differentiated by bit rate.

#### E7.1.1 Channel Types

There are different types of channels used to provide Special Access (a.k.a. BellSouth SPA) services. Each type has its own characteristics. All are subdivided by one or more of the following:

- Transmission specifications
- Bandwidth
- Speed (i.e., bit rate)
- Spectrum

Customers can order a basic channel and select from a list of available transmission parameters and channel interfaces, those that they desire to meet specific communications requirements.

For purposes of ordering channels, each has been identified as a type of Special Access (a.k.a. BellSouth SPA) service. However, such identification is not intended to limit a customer's use of the channel nor to imply that the channel is limited to a particular use.

Following is a brief description of each type of channel:

Voice Grade (a.k.a. BellSouth SPA DS0 VG)<sup>4</sup> - a channel for the transmission of analog signals within an approximate bandwidth of 300-3000 Hz.

WATS Access Line (a.k.a. BellSouth SPA WATS Line)<sup>4</sup> (WAL) - a channel from a customer designated premises to a WATS serving office for 800, WATS or similar service.

**(DELETED)**

(T)

Digital Data Access (a.k.a. BellSouth SPA DS0 Digital Data)<sup>4</sup> - a channel for the digital transmission of synchronous serial data at rates of 2.4, 4.8, 9.6, 19.2, 56.0 or 64.0 kbps.

High Capacity (a.k.a. BellSouth SPA High Capacity) - a channel for the transmission of isochronous serial digital data at rates of 1.544, 3.152, 6.312 or 44.736 Mbps.

Derived Data Channel (a.k.a. BellSouth SPA Derived Data Channel)<sup>4</sup> - a digital data channel derived from a two-wire local exchange facility that transmits voice and data signals simultaneously.

**Note 1:** Company Centrex Type Services switches and Company Answering Service Concentrators are considered to be customer premises for purposes of administering regulations and rates contained in this Tariff.

**Note 2:** For purposes of administering the surcharge regulations, WATS (a.k.a. BellSouth SPA WATS Line) access lines are considered to be Special Access (a.k.a. BellSouth SPA) service.

**Note 3:** **(DELETED)**

(T)

**Note 4:** Effective June 30, 2021, this Service will no longer be available for purchase by new or existing customers. In addition, requests to move, add, change, or renew existing service arrangements will not be accepted. Following the expiration of a customer's existing term agreement, service will be provided on a month-to-month basis at the applicable Monthly rates until the service is discontinued. The Company currently plans to discontinue this service on or after June 30, 2024.

BELLSOUTH  
TELECOMMUNICATIONS  
TENNESSEE

ACCESS SERVICES TARIFF

Twelfth Revised Page 2  
Cancels Eleventh Revised Page 2

ISSUED: November 10, 2021  
BY: Joelle Phillips, President - Tennessee  
Nashville, Tennessee

EFFECTIVE: December 1, 2021

## E7. SPECIAL ACCESS (A.K.A. BELLSOUTH SPA) SERVICE

### E7.1 General (Cont'd)

#### E7.1.1 Channel Types (Cont'd)

Detailed descriptions of each of the channel types are provided in E7.2 following.

The customer also has the option of ordering digital high capacity facilities (i.e., 1.544 Mbps, 3.152 Mbps, 6.312 Mbps and 44.736 Mbps) to a Company Hub for channelization to individual channels of a lower capacity. Descriptions of the types of channelization available at the hubs, as well as the number of individual channels which may be derived from each type of facility are set forth in E7.2 following. Additionally, the customer may specify optional features for the individual channels derived from the facility to further tailor the channel to meet specific communications requirements. Descriptions of the optional features and functions available are also set forth in E7.2 following.

For example, a customer may order a 44.736 Mbps facility from a customer designated premises to a Company Hub for channelization to twenty-eight 1.544 Mbps channels. The 1.544 Mbps channels may be further channelized at the same or a different Hub to Voice Grade (a.k.a. BellSouth SPA DS0 VG)<sup>1</sup> channels or may be extended to other customer designated premises. Optional features may be added to either the 1.544 Mbps or the Voice Grade (a.k.a. BellSouth SPA DS0 VG)<sup>1</sup> channels.

#### E7.1.2 Rate Categories

The following rate categories which apply to Special Access (a.k.a. BellSouth SPA) service:

- Local Channels (described in E7.1.2.A. following)
- Interoffice Channel (described in E7.1.2.B. following)
- Optional Features and Functions (described in E7.1.2.C. following)
- SMARTPath<sup>®</sup> service (a.k.a. BellSouth SPA Shared Ring) Area Connections (described in E7.1.2.D. following)
- SMARTPath<sup>®</sup> service (a.k.a. BellSouth SPA Shared Ring) Area Junctions (described in E7.1.2.D. following)
- SMARTRing<sup>®2</sup> service (a.k.a. BellSouth Dedicated Ring) (described in E. following)

##### A. Local Channel

The Local Channel rate category provides for the communications path between the demarcation point at a customer premises and the serving wire center of that premises. Included as part of the Local Channel is a standard channel interface arrangement which defines the technical characteristics associated with the type of facilities to which the access service is to be connected at the Point of Termination (POT) and the type of signaling capability, if any. The signaling capability itself is provided as an optional feature as set forth in C. following. One Local Channel charge applies per customer designated premises at which the channel is terminated. This charge will apply even if the customer premises and the serving wire center are co-located in a Company building.

##### B. Interoffice Channel

The Interoffice Channel rate category provides for the transmission facilities between the serving wire centers associated with two customer designated premises, between a serving wire center associated with a customer designated premises and a Company Hub or between two Company Hubs. Interoffice Channel mileage is portrayed in mileage bands. There are two rates that apply for each band, i.e., a flat rate per band and a rate per mile.

##### C. Optional Features and Functions

The Optional Features and Functions rate category provides for optional features and functions which may be added to a Special Access (a.k.a. BellSouth SPA) service to improve its quality or utility to meet specific communications requirements. These are not necessarily identifiable with specific equipment, but rather represent the end result in terms of performance characteristics which may be obtained. These characteristics may be obtained by using various combinations of equipment. Although the equipment necessary to perform a specified function may be installed at various locations along the path of the service, they will be charged for as a single rate element.

**Note 1:** Effective June 30, 2021, this Service will no longer be available for purchase by new or existing customers. In addition, requests to move, add, change, or renew existing service arrangements will not be accepted. Following the expiration of a customer's existing term agreement, service will be provided on a month-to-month basis at the applicable Monthly rates until the service is discontinued. The Company currently plans to discontinue this service on or after June 30, 2024.

**Note 2:** Effective on or after December 1, 2021, neither new nor existing customers will be permitted to purchase new SMARTRing Service (Service). In addition, (A) Service Payment Plans greater than 12-months in length will no longer be available; and (B) requests to move, add, change, upgrade, or downgrade existing service arrangements will not be accepted, with the following exceptions: (1) existing customers will be permitted to modify their existing Service and will be able to add new circuits to their existing Service, but will not be permitted to add new nodes in any locations; and (2) any such new circuits will be subject to the customer's existing term payment plan or term agreement for the Service to which they are added. Following the expiration of a customer's existing term agreement, Service will be provided on a month-to-month basis at the applicable Month-to-Month rates until the Service is discontinued.

Effective November 30, 2023, unless specified to the contrary in their existing Service agreements, existing customers may not renew Term Payment Plans or term agreements for Service. In addition, no move, add, or change orders of any type will be accepted.

Material previously appearing on this page now appears on page(s) 3 of this section.

<sup>®</sup> Registered Service Mark of BellSouth Corporation

\* Service Mark of BellSouth Corporation

BELLSOUTH  
TELECOMMUNICATIONS  
TENNESSEE

ACCESS SERVICES TARIFF

Eighth Revised Page 3  
Cancels Seventh Revised Page 3

ISSUED: November 10, 2021

EFFECTIVE: December 1, 2021

BY: Joelle Phillips, President - Tennessee  
Nashville, Tennessee

## E7. SPECIAL ACCESS (A.K.A. BELLSOUTH SPA) SERVICE

### E7.1 General (Cont'd)

#### E7.1.2 Rate Categories (Cont'd)

##### C. (Cont'd)

Examples of Optional Features and Functions that are available include, but are not limited to, the following: (M1)

- Signaling Capability
- Hubbing Functions
- Conditioning
- Transfer Arrangements
- FlexServ<sup>®</sup> service (a.k.a. BellSouth SPA Customer Reconfiguration)

A Hub is a Company designated serving wire center at which bridging or channelization functions are performed. The bridging functions performed are to connect three or more customer designated premises in a multipoint arrangement. The channelization functions are to channelize analog or digital facilities to individual services requiring a lower capacity. National Exchange Carrier Association Tariff FCC No. 4 identifies serving wire centers, Hub locations and the type of bridging or channelization functions available.

Descriptions for each of the available Optional Features and Functions are set forth in E7.2 following.

##### D. The SMARTPath<sup>®</sup> service (a.k.a. BellSouth SPA Shared Ring) Area Connection provides for the connection at the designated premises where the customer gains access to SMARTPath<sup>®</sup> service (a.k.a. BellSouth SPA Shared Ring) and transport to a designated junction in the same SMARTPath<sup>®</sup> service (a.k.a. BellSouth SPA Shared Ring) area.

The SMARTPath<sup>®</sup> service (a.k.a. BellSouth SPA Shared Ring) Area Junction provides for the connection between the SMARTPath<sup>®</sup> service (a.k.a. BellSouth SPA Shared Ring) network and (1) another customer designated premises, in the same SMARTPath<sup>®</sup> service (a.k.a. BellSouth SPA Shared Ring) Area or (2) a serving wire center in the same SMARTPath<sup>®</sup> service (a.k.a. BellSouth SPA Shared Ring) Area for connection to (a) DS1 Basic Channelization, FlexServ<sup>®</sup> service (a.k.a. BellSouth SPA Customer Reconfiguration), or DS3 (a.k.a. BellSouth SPA DS3) service as provided in Section E7. of this Tariff, or (b) a SMARTPath<sup>®</sup> service (a.k.a. BellSouth SPA Shared Ring) Area Junction of another SMARTPath<sup>®</sup> service (a.k.a. BellSouth SPA Shared Ring) area in the same Metropolitan Area.

##### E. Self-healing Multi-nodal Alternate Route Topology Ring (SMARTRing<sup>®</sup> service [a.k.a. BellSouth Dedicated Ring]) (C)

###### 1. Customer Node

Customer Nodes provide ring switching capabilities at customer designated locations other than Telephone Company Premises that are part of SMARTRing<sup>®</sup> service (a.k.a. BellSouth Dedicated Ring). This rate element offers OC-3, OC-3+, OC-12, OC-48, or OC-48+ network capacities. An OC-1 network capacity is available only in an Overlay Ring Arrangement riding the customer's host OC-12, OC-48, or OC-48+ SMARTRing<sup>®</sup> service (a.k.a. BellSouth Dedicated Ring) installed on or after June 3, 1994. A summary of the channel interfaces available with each node are specified in E7.2.16.A following.

###### 2. Customer Channel Interface

A Customer Channel Interface provides DS1, DS3, STS-1 electrical channelization and/or OC-3 and/or OC-12 optical channelization that may take place at each Customer Node of SMARTRing<sup>®</sup> service (a.k.a. BellSouth Dedicated Ring). The Customer Channel Interface rate element applies for every interface capacity that originates or terminates at a Customer Node. A summary of the channel interfaces available with each node are specified in E7.2.16.A. following.

###### 3. Central Office Node

Central Office Nodes provide ring switching capabilities at Telephone Company Central Offices that are a part of SMARTRing<sup>®</sup> service (a.k.a. BellSouth Dedicated Ring). This rate element offers OC-3, OC-3+, OC-12, OC-48, and OC-48+ network capacities. An OC-1 network capacity is available only in an Overlay Ring Arrangement riding the customer's host OC-12, OC-48 or OC-48+ SMARTRing<sup>®</sup> service (a.k.a. BellSouth Dedicated Ring) installed on or after June 3, 1994. A summary of the channel interfaces available with each node are specified in E7.2.16.A. following. (M2)

**Note 1:** Effective on or after December 1, 2021, neither new nor existing customers will be permitted to purchase new SMARTRing Service (Service). In addition, (A) Service Payment Plans greater than 12-months in length will no longer be available; and (B) requests to move, add, change, upgrade, or downgrade existing service arrangements will not be accepted, with the following exceptions: (1) existing customers will be permitted to modify their existing Service and will be able to add new circuits to their existing Service, but will not be permitted to add new nodes in any locations; and (2) any such new circuits will be subject to the customer's existing term payment plan or term agreement for the Service to which they are added. Following the expiration of a customer's existing term agreement, Service will be provided on a month-to-month basis at the applicable Month-to-Month rates until the Service is discontinued. (N)

Effective November 30, 2023, unless specified to the contrary in their existing Service agreements, existing customers may not renew Term Payment Plans or term agreements for Service. In addition, no move, add, or change orders of any type will be accepted. (N)

M1 Material appearing on this page previously appeared on page(s) 2 of this section.

M2 Material previously appearing on this page now appears on page(s) 3.1 of this section.

BELLSOUTH  
TELECOMMUNICATIONS  
TENNESSEE

ACCESS SERVICES TARIFF

Fifth Revised Page 3.1  
Cancels Fourth Revised Page 3.1

ISSUED: November 10, 2021  
BY: Joelle Phillips, President - Tennessee  
Nashville, Tennessee

EFFECTIVE: December 1, 2021

## E7. SPECIAL ACCESS (A.K.A. BELLSOUTH SPA) SERVICE

### E7.1 General (Cont'd)

#### E7.1.2 Rate Categories (Cont'd)

- E.** Self-healing Multi-nodal Alternate Route Topology Ring (SMARTRing<sup>1</sup> service [a.k.a. BellSouth Dedicated Ring]) (Cont'd) (C)
4. Central Office Channel Interface (M)
 

A Central Office Channel Interface provides DS1, DS3, STS-1 electrical channelization and/or OC-3 and/or OC-12 optical channelization that may take place at each Central Office Node located on SMARTRing<sup>®</sup> service (a.k.a. BellSouth Dedicated Ring). The Central Office Channel Interface rate element applies for every interface capacity that originates or terminates at a Central Office Node. A summary of the channel interfaces available with each node are specified in E7.2.16.A. following. Customers with DS3 or STS-1 interfaces at the Customer Node electing to connect with DS1 services at a Central Office Node, must obtain a 28-DS1 Channel System.
  5. Local Channel (M)
 

The Local Channel rate category provides for the communications path between a Customer Node and the serving wire center of the premises where located. Charges for Local Channels apply as described in A. preceding. It is available with all capacities of SMARTRing<sup>®</sup> service (a.k.a. BellSouth Dedicated Ring) except OC-1.
  6. Alternate Central Office Channel
 

The Alternate Central Office Channel provides for the communications path between a customer node and an alternate central office. It is available with all capacities of SMARTRing service (a.k.a. BellSouth Dedicated Ring) except OC-1.
  7. Interoffice Channel
 

The Interoffice Channel provides for the communications path between directly connected Telephone Company central offices located on a SMARTRing service (a.k.a. BellSouth Dedicated Ring). It is available with all capacities of SMARTRing service (a.k.a. BellSouth Dedicated Ring) except OC-1. This rate element does not apply where Central Office Nodes are adjacently connected in the same Central Office on the same SMARTRing service (a.k.a. BellSouth Dedicated Ring) for the purpose of providing additional node capacity.
  8. Internodal Channel
 

The Internodal Channel provides for the communications path between two directly connected Customer Nodes of a given SMARTRing service (a.k.a. BellSouth Dedicated Ring) located (a) in the same Serving Wire Center area or (b) in the same Office Park/Campus Environment or contiguous property, located in contiguous Serving Wire Center areas. It is available with all capacities of SMARTRing service (a.k.a. BellSouth Dedicated Ring) except OC-1. This rate element does not apply where Customer Nodes are adjacently connected in the same building on the same SMARTRing service (a.k.a. BellSouth Dedicated Ring) for the purpose of providing additional node capacity.
  9. Channel Interface Capacity Reallocation
 

Channel Interface Capacity Reallocation allows the customer to reallocate STS-1, DS3 capacity interfaces at each node subsequent to the initial service installation.
- F. Reserved for Future Use**
- G.** Access Collocation Cross-Connects
- Access Collocation Cross-Connects provide a means for customers to interconnect their Shared Use and Digital High Capacity (a.k.a. BellSouth SPA High Capacity) to Central Office Collocation arrangements within the same Central Office. Terms, conditions, and rates for Physical Access Collocation Cross-Connects and Virtual Access Collocation Cross-Connects are set forth in Section E13. of this Tariff.

**Note 1:** Effective on or after December 1, 2021, neither new nor existing customers will be permitted to purchase new SMARTRing Service (Service). In addition, (A) Service Payment Plans greater than 12-months in length will no longer be available; and (B) requests to move, add, change, upgrade, or downgrade existing service arrangements will not be accepted, with the following exceptions: (1) existing customers will be permitted to modify their existing Service and will be able to add new circuits to their existing Service, but will not be permitted to add new nodes in any locations; and (2) any such new circuits will be subject to the customer's existing term payment plan or term agreement for the Service to which they are added. Following the expiration of a customer's existing term agreement, Service will be provided on a month-to-month basis at the applicable Month-to-Month rates until the Service is discontinued. (N)

Effective November 30, 2023, unless specified to the contrary in their existing Service agreements, existing customers may not renew Term Payment Plans or term agreements for Service. In addition, no move, add, or change orders of any type will be accepted. (N)

BELLSOUTH  
TELECOMMUNICATIONS  
TENNESSEE

ACCESS SERVICES TARIFF

Original Page 3.2

ISSUED: December 7, 1998

EFFECTIVE: January 6, 1999

BY: Joelle Phillips, President - Tennessee  
Nashville, Tennessee

## E7. SPECIAL ACCESS (A.K.A. BELLSOUTH SPA) SERVICE

### E7.1 General (Cont'd)

(N)

#### E7.1.3 Service Configurations

(M)

There are three types of service configurations over which Special Access (a.k.a. BellSouth SPA) services are provided: two-point service and multipoint service.

(M)

##### A. Two-Point Service

(M)

A two-point service connects two customer designated premises, either on a directly connected basis or through a hub where channelization functions are performed or through FlexServ<sup>®</sup> service (a.k.a. BellSouth SPA Customer Reconfiguration) or a FlexServ<sup>®</sup> service (a.k.a. BellSouth SPA Customer Reconfiguration) optional feature, where one or more may be available.

(M)

Applicable rate elements are:

(M)

- Local Channels

(M)

- Interoffice Channels (as applicable)

(M)

- Optional Features and Functions (when applicable)

In addition, a Special Access (a.k.a. BellSouth SPA) Surcharge as set forth in E7.4.2 following and a Message Station Equipment Recovery Charge as set forth in E7.4.3 following may be applicable.

(M)

Material appearing on this page previously appeared on page(s) 3.1 of this section.

<sup>®</sup> Registered Service Mark of BellSouth Corporation



## E7. SPECIAL ACCESS (A.K.A. BELLSOUTH SPA) SERVICE

### E7.1 General (Cont'd)

#### E7.1.3 Service Configurations (Cont'd)

##### A. Two-Point Service (Cont'd)

The following diagram depicts a two-point Voice Grade (*a.k.a. BellSouth SPA DS0 VG*)<sup>1</sup> service connecting two customer designated premises located 15 miles apart. The service is provided with C-Type Conditioning. (C)

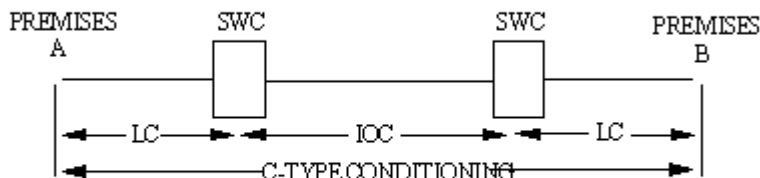

LC - Local Channel\*  
IOC - Interoffice Channel\*\*  
SWC - Serving Wire Center

Applicable rate elements are:

- Local Channels (2 applicable)
- Interoffice Channels (mileage band over 9 thru 25 miles)
- C-Type conditioning Optional Feature

##### B. Multipoint Service

Multipoint service connects three or more customer designated premises through a Company Hub. There is no limitation on the number of mid-links available with multipoint service. However, when more than three mid-links are provided in tandem, the quality of the service may be degraded. A mid-link is a channel between hubs (i.e., bridging locations). Only certain types of Special Access (*a.k.a. BellSouth SPA*) service are provided as multipoint service. These are so designated in the Service Descriptions set forth in E7.2. following.

When ordering, the customer will specify the desired bridging Hub(s) selected from the Exchange Carrier Association Tariff F.C.C. No. 4. This tariff identifies the type(s) of bridging functions which are available and the serving wire centers at which they are available.

Applicable Rate Elements are:

- Local Channels (one per customer designated premises)
- Interoffice Channels (as applicable between each designated customer premises and the Hub and between Hubs)
- Bridging
- Additional Optional Features (when applicable)

Note 1: Effective June 30, 2021, this Service will no longer be available for purchase by new or existing customers. In addition, requests to move, add, change, or renew existing service arrangements will not be accepted. Following the expiration of a customer's existing term agreement, service will be provided on a month-to-month basis at the applicable Monthly rates until the service is discontinued. The Company currently plans to discontinue this service on or after June 30, 2024.

BELLSOUTH  
TELECOMMUNICATIONS  
TENNESSEE

ACCESS SERVICES TARIFF

First Revised Page 4.1  
Cancels Original Page 4.1

ISSUED: November 10, 2021

EFFECTIVE: December 1, 2021

BY: Joelle Phillips, President - Tennessee  
Nashville, Tennessee

## E7. SPECIAL ACCESS (A.K.A. BELLSOUTH SPA) SERVICE

### E7.1 General (Cont'd)

#### E7.1.4 Service Configurations (Cont'd)

- C. SMARTRing<sup>®</sup> service (a.k.a. BellSouth Dedicated Ring) (C)
1. The SMARTRing<sup>®</sup> service (a.k.a. BellSouth Dedicated Ring) configuration utilizes a multi-nodal ring architecture which is specified jointly by the Company and the customer. The minimum configuration provides dedicated DS3 and/or DS1 digital services and must include at least three nodes. The three nodes may all be Central Office Nodes in Telephone Company Central Offices, or the three nodes may be a Central Office Node in a Telephone Company Central Office, a Customer Node at a customer's designated location and the third node may be either a Central Office Node or a node at another customer designated location. Additional nodes for either arrangement may be any combination thereof. The maximum number of nodes will be determined based on equipment capability. The nodes are connected by SMARTRing<sup>®</sup> service (a.k.a. BellSouth Dedicated Ring) Local Channels, Alternate Central Office Channels, Interoffice Channels and Internodal Channels as applicable. SMARTRing<sup>®</sup> service (a.k.a. BellSouth Dedicated Ring) may be connected to other DS3/DS1 services only at Central Office Nodes. With OC-12 SMARTRing<sup>®</sup> service (a.k.a. BellSouth Dedicated Ring) installed on or after June 3, 1994, and with OC-48 and OC-48+ SMARTRing<sup>®</sup> service (a.k.a. BellSouth Dedicated Ring) the customer may request an OC-1 and/or OC-3 Overlay Ring Arrangement riding the customer's host OC-12, OC-48, or OC-48+ SMARTRing<sup>®</sup> service (a.k.a. BellSouth Dedicated Ring). With OC-48 SMARTRing<sup>®</sup> service (a.k.a. BellSouth Dedicated Ring), the customer may request an OC-3+ and/or OC-12 Overlay Ring Arrangement riding the customer's host OC-48 SMARTRing<sup>®</sup> service (a.k.a. BellSouth Dedicated Ring). In an Overlay Ring Arrangement, node and channel configuration requirements apply to the host SMARTRing<sup>®</sup> service (a.k.a. BellSouth Dedicated Ring).
  2. Applicable rate elements for this service are:
    - a. Customer Node (at least one for configurations other than three Central Office Node arrangement)
    - b. Customer Channel Interface (one for each originating/terminating activated DS1, DS3, STS-1, OC-3, and/or OC-12 for each Customer Node)
    - c. Central Office Node (at least one for configurations other than three Central Office Node arrangement)
    - d. Central Office Channel Interface (one for each originating/terminating activated DS1, DS3, STS-1, OC-3 and/or OC-12 for each Central Office Node or one for each 28 DS1 Channel System and associated DS1 Channel Interfaces for each activated DS3)
    - e. Local Channel (at least one for each Customer Node which is directly connected to the serving wire center)
    - f. Alternate Central Office Channel (at least one for each Customer Node which is directly connected to an Alternate Central Office)
    - g. Internodal Channel (one for each path between two directly connected customer nodes)
    - h. Interoffice Channel (one for each path between each two directly connected Telephone Company Central Offices)
    - i. Channel Interface Capacity Reallocation (one per node per occurrence)

**Note 1:** Effective on or after December 1, 2021, neither new nor existing customers will be permitted to purchase new SMARTRing Service (Service). In addition, (A) Service Payment Plans greater than 12-months in length will no longer be available; and (B) requests to move, add, change, upgrade, or downgrade existing service arrangements will not be accepted, with the following exceptions: (1) existing customers will be permitted to modify their existing Service and will be able to add new circuits to their existing Service, but will not be permitted to add new nodes in any locations; and (2) any such new circuits will be subject to the customer's existing term payment plan or term agreement for the Service to which they are added. Following the expiration of a customer's existing term agreement, Service will be provided on a month-to-month basis at the applicable Month-to-Month rates until the Service is discontinued. (N)

Effective November 30, 2023, unless specified to the contrary in their existing Service agreements, existing customers may not renew Term Payment Plans or term agreements for Service. In addition, no move, add, or change orders of any type will be accepted. (N)

## E7. SPECIAL ACCESS (A.K.A. BELLSOUTH SPA) SERVICE

### E7.1 General (Cont'd)

#### E7.1.4 Service Configurations

C. SMARTRing<sup>®</sup> service (a.k.a. BellSouth Dedicated Ring) (Cont'd)

(C)

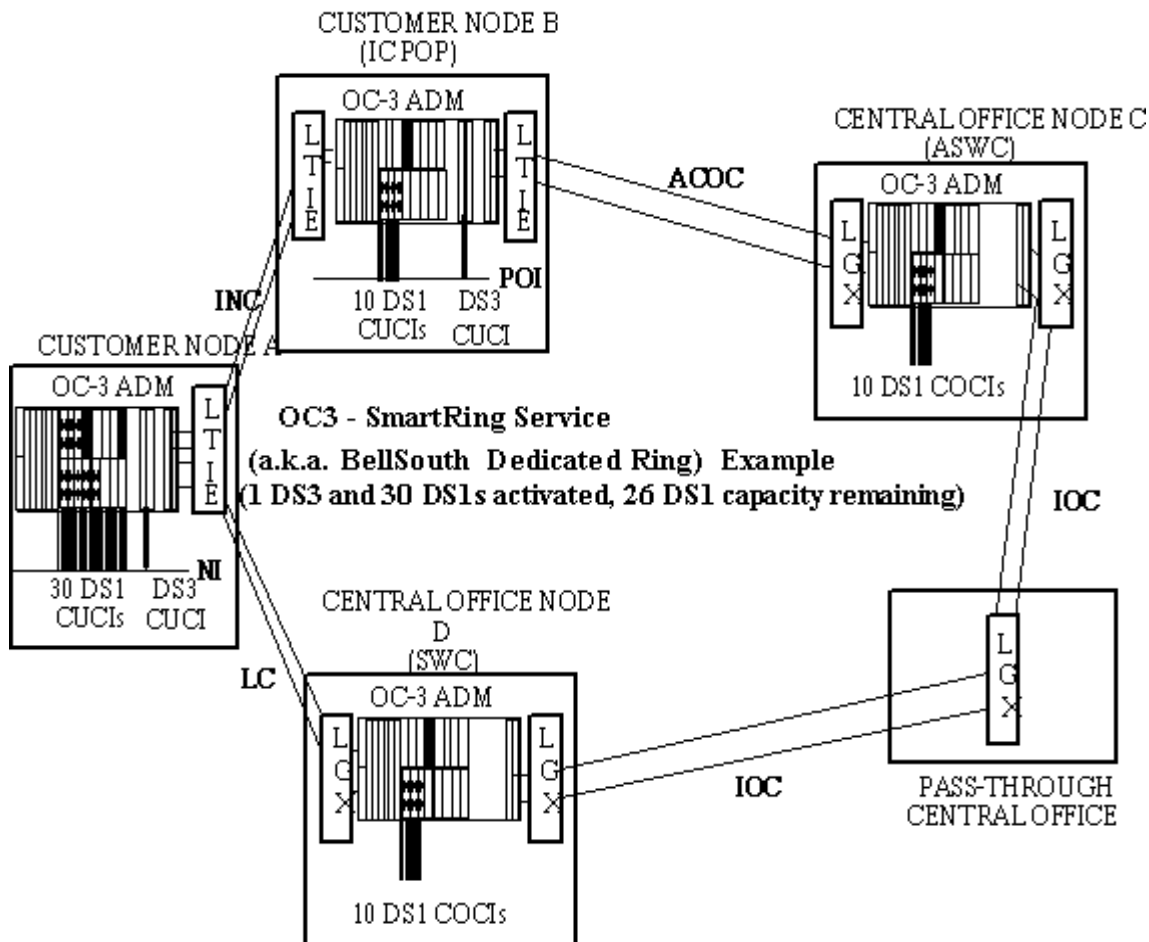

**Example: SMARTRing<sup>®</sup> service (a.k.a. BellSouth Dedicated Ring) OC-3 capacity.**

For this example the following rate elements are applicable:

(C)

- 2 Customer Nodes
- 1 Internodal Channel
- 2 DS3 Customer Channel Interfaces
- 2 Central Office Nodes
- 1 Alternate Central Office Channel
- 40 DS1 Customer Channel Interfaces
- 1 Local Channel
- 2 Interoffice Channels
- 20 DS1 Central Office Channel Interfaces

**Note 1:** Effective on or after December 1, 2021, neither new nor existing customers will be permitted to purchase new SMARTRing Service (Service). In addition, (A) Service Payment Plans greater than 12-months in length will no longer be available; and (B) requests to move, add, change, upgrade, or downgrade existing service arrangements will not be accepted, with the following exceptions: (1) existing customers will be permitted to modify their existing Service and will be able to add new circuits to their existing Service, but will not be permitted to add new nodes in any locations; and (2) any such new circuits will be subject to the customer's existing term payment plan or term agreement for the Service to which they are added. Following the expiration of a customer's existing term agreement, Service will be provided on a month-to-month basis at the applicable Month-to-Month rates until the Service is discontinued.

(N)

Effective November 30, 2023, unless specified to the contrary in their existing Service agreements, existing customers may not renew Term Payment Plans or term agreements for Service. In addition, no move, add, or change orders of any type will be accepted.

(N)

**E7. SPECIAL ACCESS (A.K.A. BELLSOUTH SPA) SERVICE**

**E7.1 General (Cont'd)**

**E7.1.4 Service Configurations (Cont'd)**

C. SMARTRing<sup>®</sup> service (a.k.a. BellSouth Dedicated Ring) (Cont'd)

(C)

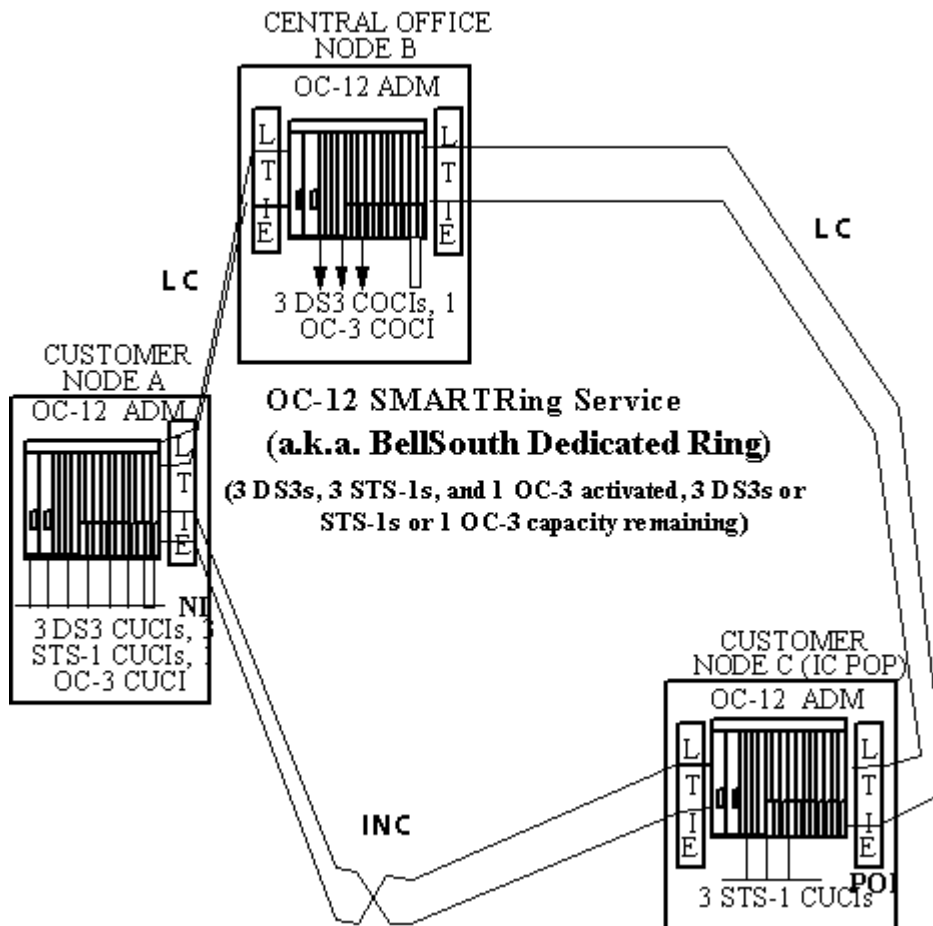

**Example: SMARTRing<sup>®</sup> service (a.k.a. BellSouth Dedicated Ring) OC-12 capacity.**

For this example the following rate elements are applicable:

(C)

- 2 Customer Nodes
- 1 Internodal Channel
- 6 STS-1 Customer Channel Interfaces
- 1 Central Office Nodes
- 3 DS3 Customer Channel Interfaces
- 1 OC-3 Customer Channel Interface
- 2 Local Channels
- 3 DS3 Central Office Channel Interfaces
- 1 OC-3 Central Office Channel Interface

**Note 1:** Effective on or after December 1, 2021, neither new nor existing customers will be permitted to purchase new SMARTRing Service (Service). In addition, (A) Service Payment Plans greater than 12-months in length will no longer be available; and (B) requests to move, add, change, upgrade, or downgrade existing service arrangements will not be accepted, with the following exceptions: (1) existing customers will be permitted to modify their existing Service and will be able to add new circuits to their existing Service, but will not be permitted to add new nodes in any locations; and (2) any such new circuits will be subject to the customer's existing term payment plan or term agreement for the Service to which they are added. Following the expiration of a customer's existing term agreement, Service will be provided on a month-to-month basis at the applicable Month-to-Month rates until the Service is discontinued.

(N)

Effective November 30, 2023, unless specified to the contrary in their existing Service agreements, existing customers may not renew Term Payment Plans or term agreements for Service. In addition, no move, add, or change orders of any type will be accepted.

(N)

**E7. SPECIAL ACCESS (A.K.A. BELLSOUTH SPA) SERVICE**

**E7.1 General (Cont'd)**

**E7.1.4 Service Configurations (Cont'd)**

C. SMARTRing<sup>®</sup> service (a.k.a. BellSouth Dedicated Ring) (Cont'd)

(C)

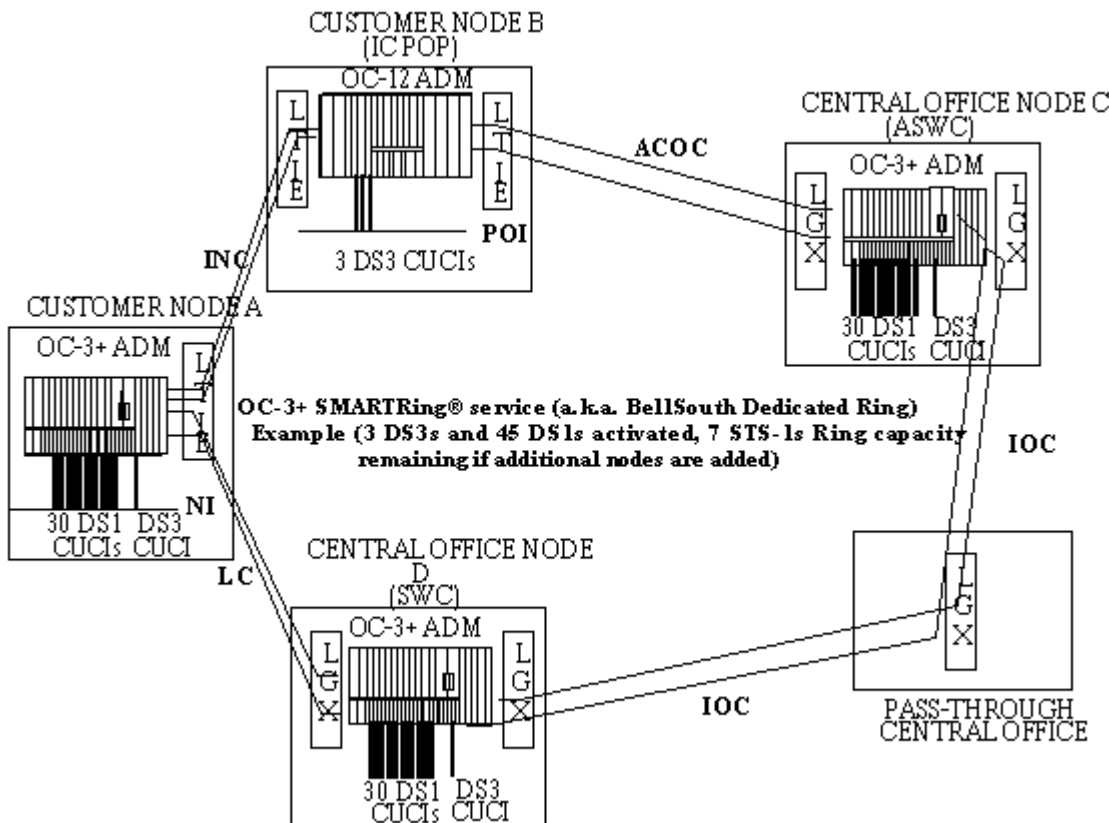

**Example: SMARTRing<sup>®</sup> service (a.k.a. BellSouth Dedicated Ring) OC-3+ capacity.**

For this example the following rate elements are applicable:

(C)

- 2 Customer Nodes
- 1 Alternate Central Office Channel
- 2 DS3 Central Office Channel Interfaces
- 2 Central Office Nodes
- 2 Interoffice Channels
- 30 DS1 Customer Channel Interfaces
- 1 Local Channel
- 4 DS3 Customer Channel Interfaces
- 60 DS1 Central Office Channel Interfaces
- 1 Internodal Channel

**Note 1:** Effective on or after December 1, 2021, neither new nor existing customers will be permitted to purchase new SMARTRing Service (Service). In addition, (A) Service Payment Plans greater than 12-months in length will no longer be available; and (B) requests to move, add, change, upgrade, or downgrade existing service arrangements will not be accepted, with the following exceptions: (1) existing customers will be permitted to modify their existing Service and will be able to add new circuits to their existing Service, but will not be permitted to add new nodes in any locations; and (2) any such new circuits will be subject to the customer's existing term payment plan or term agreement for the Service to which they are added. Following the expiration of a customer's existing term agreement, Service will be provided on a month-to-month basis at the applicable Month-to-Month rates until the Service is discontinued.

(N)

Effective November 30, 2023, unless specified to the contrary in their existing Service agreements, existing customers may not renew Term Payment Plans or term agreements for Service. In addition, no move, add, or change orders of any type will be accepted.

(N)

**E7. SPECIAL ACCESS (A.K.A. BELLSOUTH SPA) SERVICE**

**E7.1 General (Cont'd)**

**E7.1.4 Service Configurations (Cont'd)**

C. SMARTRing®<sup>1</sup> service (a.k.a. BellSouth Dedicated Ring) (Cont'd)

(C)

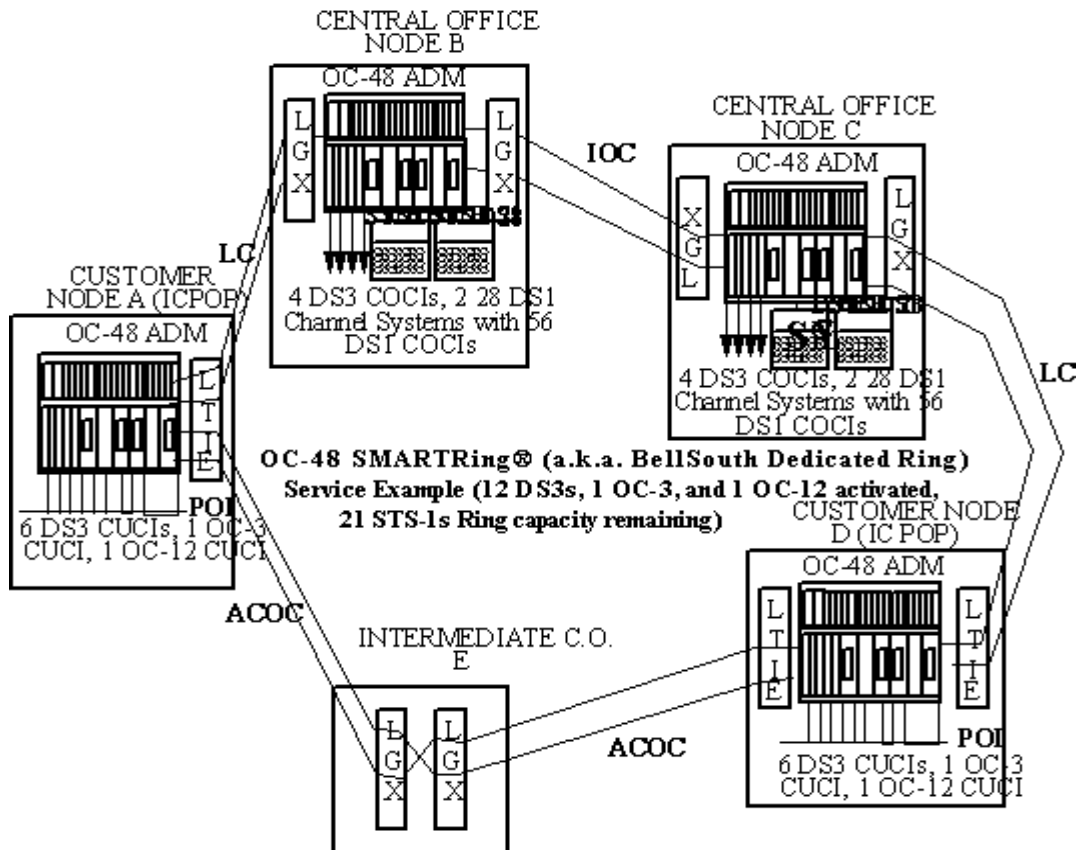

**Example: SMARTRing® service (a.k.a. BellSouth Dedicated Ring) OC-48 capacity.**

For this example the following rate elements are applicable:

(C)

- 2 Customer Nodes
- 2 Alternate Central Office Channels
- 112 DS1 Central Office Channel Interfaces
- 2 Central Office Nodes
- 12 DS3 Customer Channel Interfaces
- 2 OC-3 Customer Channel Interfaces
- 2 Local Channels
- 8 DS3 Central Office Channel Interfaces
- 2 OC-12 Customer Channel Interfaces
- 1 Interoffice Channel
- 4 28 DS1 Channel Systems (DS3)

**Note 1:** Effective on or after December 1, 2021, neither new nor existing customers will be permitted to purchase new SMARTRing Service (Service). In addition, (A) Service Payment Plans greater than 12-months in length will no longer be available; and (B) requests to move, add, change, upgrade, or downgrade existing service arrangements will not be accepted, with the following exceptions: (1) existing customers will be permitted to modify their existing Service and will be able to add new circuits to their existing Service, but will not be permitted to add new nodes in any locations; and (2) any such new circuits will be subject to the customer's existing term payment plan or term agreement for the Service to which they are added. Following the expiration of a customer's existing term agreement, Service will be provided on a month-to-month basis at the applicable Month-to-Month rates until the Service is discontinued.

(N)

Effective November 30, 2023, unless specified to the contrary in their existing Service agreements, existing customers may not renew Term Payment Plans or term agreements for Service. In addition, no move, add, or change orders of any type will be accepted.

(N)

**E7. SPECIAL ACCESS (A.K.A. BELLSOUTH SPA) SERVICE**

**E7.1 General (Cont'd)**

**E7.1.4 Service Configurations (Cont'd)**

C. SMARTRing® service (a.k.a. BellSouth Dedicated Ring) (Cont'd)

(C)

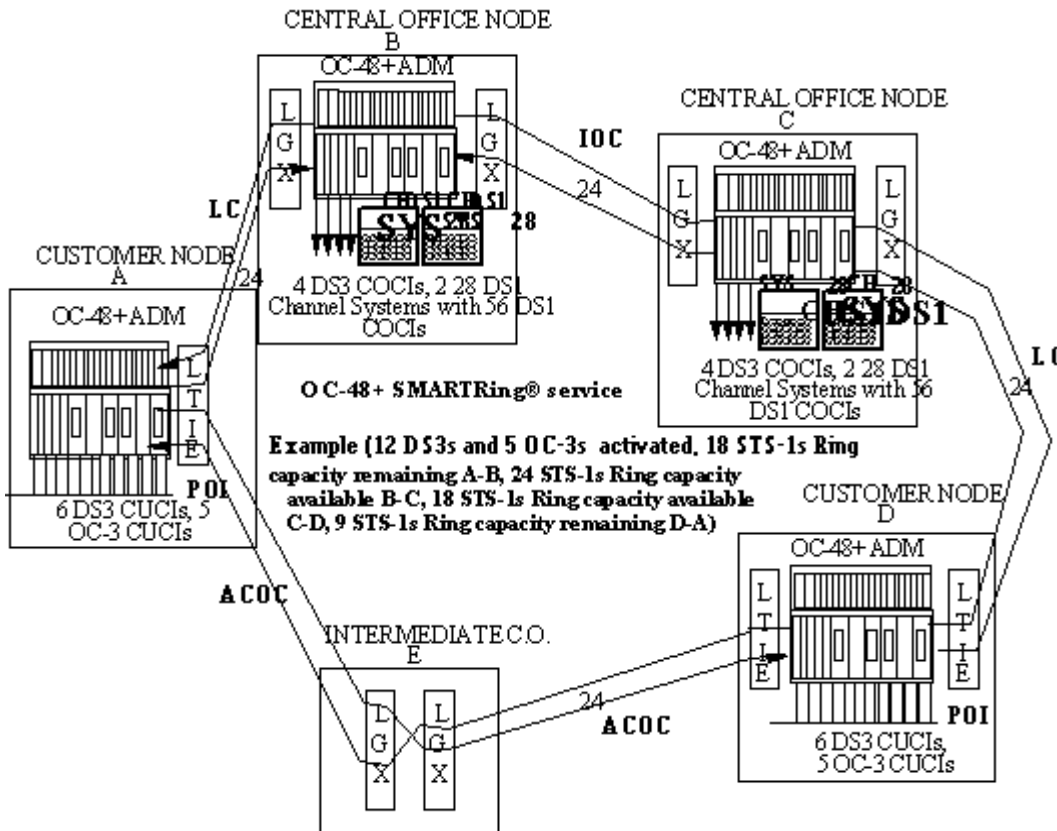

**Example: SMARTRing® service (a.k.a. BellSouth Dedicated Ring) service OC-48+ capacity.**

For this example the following rate elements are applicable:

(C)

- 2 Customer Nodes
- 2 Alternate Central Office Channels
- 4 28 DS1 Channel Systems (DS3)
- 2 Central Office Nodes
- 12 DS3 Customer Channel Interfaces
- 112 DS1 Central Office Channel Interfaces
- 2 Local Channels
- 8 DS3 Central Office Channel Interfaces
- 10 OC-3 Customer Channel Interfaces
- 1 Interoffice Channel

**Note 1:** Effective on or after December 1, 2021, neither new nor existing customers will be permitted to purchase new SMARTRing Service (Service). In addition, (A) Service Payment Plans greater than 12-months in length will no longer be available; and (B) requests to move, add, change, upgrade, or downgrade existing service arrangements will not be accepted, with the following exceptions: (1) existing customers will be permitted to modify their existing Service and will be able to add new circuits to their existing Service, but will not be permitted to add new nodes in any locations; and (2) any such new circuits will be subject to the customer's existing term payment plan or term agreement for the Service to which they are added. Following the expiration of a customer's existing term agreement, Service will be provided on a month-to-month basis at the applicable Month-to-Month rates until the Service is discontinued.

(N)

Effective November 30, 2023, unless specified to the contrary in their existing Service agreements, existing customers may not renew Term Payment Plans or term agreements for Service. In addition, no move, add, or change orders of any type will be accepted.

(N)

## E7. SPECIAL ACCESS (A.K.A. BELLSOUTH SPA) SERVICE

### E7.1 General (Cont'd)

#### E7.1.3 Service Configurations (Cont'd)

B. Multipoint Service (Cont'd)

In addition, a Special Access (*a.k.a. BellSouth SPA*) Surcharge as set forth in E7.4.2. following and a Message Station Equipment Recovery Charge as set forth in E7.4.3. following may be applicable.

Example: Voice Grade (*a.k.a. BellSouth SPA DS0 VG*)<sup>1</sup> multipoint connecting four customer premises via two customer specified bridging hubs. (C)

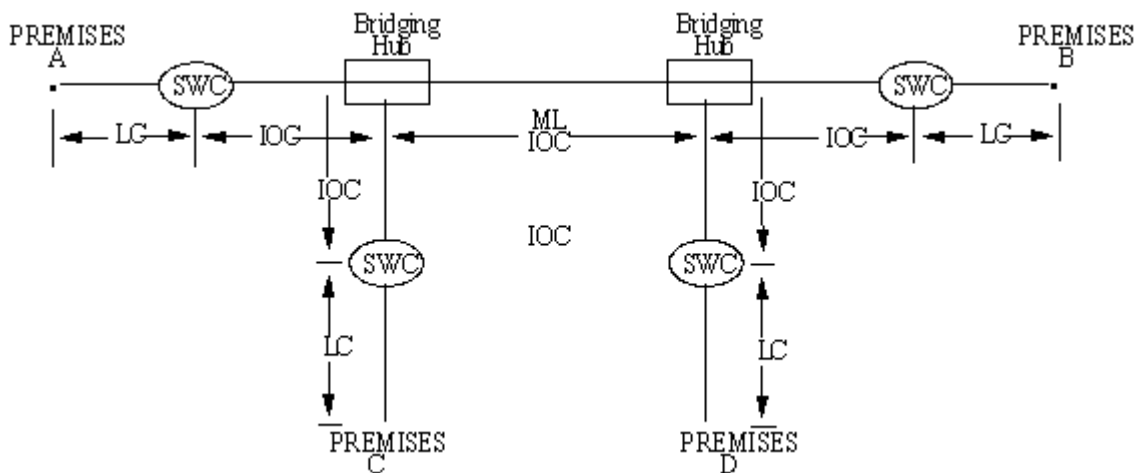

- LC = Local Channel
- IC = Interoffice Channel
- B = Bridging
- SWC = Serving Wire Center

Applicable rate elements are:

- Local Channels (4 applicable)
- Interoffice Channel (5 sections, each from appropriate mileage band)
- Bridging Optional Feature (6 applicable, i.e., each bridge port)

**Note 1:** Effective June 30, 2021, this Service will no longer be available for purchase by new or existing customers. In addition, requests to move, add, change, or renew existing service arrangements will not be accepted. Following the expiration of a customer's existing term agreement, service will be provided on a month-to-month basis at the applicable Monthly rates until the service is discontinued. The Company currently plans to discontinue this service on or after June 30, 2024.



BELLSOUTH  
TELECOMMUNICATIONS  
TENNESSEE

ACCESS SERVICES TARIFF

Sixth Revised Page 6  
Cancels Fifth Revised Page 6

ISSUED: December 9, 2022  
BY: Joelle Phillips, President - Tennessee  
Nashville, Tennessee

EFFECTIVE: January 1, 2023

## E7. SPECIAL ACCESS (A.K.A. BELLSOUTH SPA) SERVICE

### E7.1 General (Cont'd)

#### E7.1.4 Alternate Use

Alternate Use occurs when a service is arranged by the Company so that the customer can select different types of transmission at different times. A customer may use a service in any privately beneficial manner. However, where technical or engineering changes are required to effectuate an alternative use, the Company will make such special arrangements available on an individual case basis.

The arrangement required to transfer the service from one operation to the other (i.e., the transfer relay and control leads) will be rated and provided on an individual case basis and filed in Section E12., Specialized Service or Arrangements. The customer will pay the stated tariff rates for the Access Service rate elements for the service ordered (i.e., Local Channels, Interoffice Channels as applicable, and Optional Features and Functions, if any.)

#### E7.1.5 Special Facilities Routing

A customer may request that the facilities used to provide Special Access (*a.k.a. BellSouth SPA*) service be specially routed. The regulations, rates and charges for Special Facilities Routing (i.e., Avoidance, Diversity and Cable Only) are as set forth in Section E11. following.

#### E7.1.6 Design Layout Report

At the request of the customer, the Company will provide to the customer the make-up of the facilities and services provided under this Tariff as Special Access (*a.k.a. BellSouth SPA*) service to aid the customer in designing its overall service. This information will be provided in the form of a Design Layout Report.

The Design Layout Report will be provided to the customer at no charge, and will be reissued or updated whenever these facilities are materially changed.

#### E7.1.7 Acceptance Testing

At no additional charge, the Company will, at the customer's request, cooperatively test, at the time of installation, the following parameters:

- A. For Voice Grade (*a.k.a. BellSouth SPA DS0 VG*)<sup>2</sup> services, acceptance tests will include tests for loss, 3-tone slope, DC continuity, operational signaling, C-notched noise and C-message noise when these parameters are applicable and specified in the order for service. Additionally, for Voice Grade (*a.k.a. BellSouth SPA DS0 VG*)<sup>2</sup> services, a balance (improved loss) test will be made if the customer has ordered the improved loss optional feature.
- B. For other analog services (i.e., WATS Access Line (*a.k.a. BellSouth SPA WATS Line*)<sup>2</sup> and for digital services (i.e., Digital Data Access (*a.k.a. BellSouth SPA DS0 Digital Data*)<sup>2</sup>, WATS Access Line (*a.k.a. BellSouth SPA WATS Line*)<sup>2</sup> and High Capacity (*a.k.a. BellSouth SPA High Capacity*), acceptance tests will include tests for the parameters applicable to the service as specified in the order for service. (D)

In addition to the above tests, Additional Cooperative Acceptance Testing for Voice Grade (*a.k.a. BellSouth SPA DS0 VG*)<sup>2</sup> service to test other parameters, as described in E13.3.5.B. following, is available at the customer's request. All test results will be made available to the customer upon request.

#### E7.1.8 Ordering Options And Conditions

- A. The ordering option available to the customer in the provision of Special Access (*a.k.a. BellSouth SPA*) service is:
  1. Access Order
- B. This option is set forth in detail in Section E5. preceding. Also included in that section are other charges which may be associated with ordering Special Access (*a.k.a. BellSouth SPA*) service (e.g., Service Date Change Charges, Cancellation Charges, etc.).

#### Note 1: (DELETED)

Note 2: Effective June 30, 2021, this Service will no longer be available for purchase by new or existing customers. In addition, requests to move, add, change, or renew existing service arrangements will not be accepted. Following the expiration of a customer's existing term agreement, service will be provided on a month-to-month basis at the applicable Monthly rates until the service is discontinued. The Company currently plans to discontinue this service on or after June 30, 2024. (T)

BELLSOUTH  
TELECOMMUNICATIONS  
TENNESSEE

ACCESS SERVICES TARIFF

Fifteenth Revised Page 7  
Cancels Fourteenth Revised Page 7

ISSUED: December 9, 2022  
BY: Joelle Phillips, President - Tennessee  
Nashville, Tennessee

EFFECTIVE: January 1, 2023

## E7. SPECIAL ACCESS (A.K.A. BELLSOUTH SPA) SERVICE

### E7.2 Service Descriptions

For the purposes of ordering, there are ten categories of Special Access (a.k.a. BellSouth SPA) service. These are:

- Voice Grade (a.k.a. BellSouth SPA DS0 VG)<sup>2</sup> (VG)
- **(DELETED)**
- Digital Data Access (a.k.a. BellSouth SPA DS0 Digital Data)<sup>2</sup> service (DDAS)
- High Capacity (a.k.a. BellSouth SPA High Capacity) (HC)
- WATS Access Line (a.k.a. BellSouth SPA WATS Line)<sup>2</sup> (WAL)
- Derived Data Channel (a.k.a. BellSouth SPA Derived Data Channel)<sup>2</sup> service
- Self-Healing Rings (SMARTRing<sup>3</sup> service [a.k.a. BellSouth Dedicated Ring])

Each service consists of a basic channel to which a predefined technical specifications package, channel interface(s) and, when desired, optional features and functions are added to construct the service desired by the customer. Each of the components of the service are described in this section. Terms and conditions for central office interconnection of collocator-provided transmission equipment are set forth in BellSouth Telecommunications, Inc., Tariff F.C.C. No. 1, Section 20. Terms, conditions, and rates for Physical Access Collocation Cross-Connects and Virtual Access Collocation Cross-Connects are set forth in Section E13. of this Tariff for those services that are permitted to connect directly to a carrier's collocation space.

The channel description specifies the characteristics of the basic channel and indicates whether the channel is provided between customer designated premises or between a customer designated premises and a Company hub where bridging and/or channelization functions are performed.

Information pertaining to the technical specifications packages indicates the transmission parameters that are available with each package. This information is displayed in a matrix with the transmission parameters listed down the left side and the packages listed across the top. Each package is identified by a code, e.g., VG1. The first two letters of the code indicate the category of Special Access (a.k.a. BellSouth SPA) service to which the parameters are applicable. These two-letter codes are shown above in parentheses following the category of Special Access (a.k.a. BellSouth SPA) service. The number "1" following the two-letter code indicates the technical specifications package for a voice grade<sup>2</sup> service. An alphanumeric designation following the two-letter code indicates the specific predefined package. When appropriate, the Technical Reference which contains detailed specifications for the parameters is shown following the matrix.

Channel interfaces at each point of termination on a two-point service may be symmetrical or asymmetrical. On a multipoint service they may also be symmetrical or asymmetrical. However, communications can only be provided between points of termination with compatible channel interfaces. Only certain channel interfaces are compatible. These are set forth in a combination format.

Only certain channel interface combinations are available with the predefined technical specifications packages. These are delineated in the Technical References set forth at the end of this E7.2.

The optional features and functions available with each type of Special Access (a.k.a. BellSouth SPA) service are described in this section. The optional features and functions information also indicates with which technical specifications packages they are available. Such information is displayed in a matrix with the optional feature or function listed down the left side and the technical specifications package listed across the top.

The Company will maintain existing transmission specifications on services installed prior to the effective date of this Tariff, except that the existing services with performance specifications exceeding the standard listed in this provision will be maintained at the performance levels specified in this Tariff.

**Note 1:** **(DELETED)**

**Note 2:** Effective June 30, 2021, this Service will no longer be available for purchase by new or existing customers. In addition, requests to move, add, change, or renew existing service arrangements will not be accepted. Following the expiration of a customer's existing term agreement, service will be provided on a month-to-month basis at the applicable Monthly rates until the service is discontinued. The Company currently plans to discontinue this service on or after June 30, 2024.

**Note 3:** Effective on or after December 1, 2021, neither new nor existing customers will be permitted to purchase new SMARTRing Service (Service). In addition, (A) Service Payment Plans greater than 12-months in length will no longer be available; and (B) requests to move, add, change, upgrade, or downgrade existing service arrangements will not be accepted, with the following exceptions: (1) existing customers will be permitted to modify their existing Service and will be able to add new circuits to their existing Service, but will not be permitted to add new nodes in any locations; and (2) any such new circuits will be subject to the customer's existing term payment plan or term agreement for the Service to which they are added. Following the expiration of a customer's existing term agreement, Service will be provided on a month-to-month basis at the applicable Month-to-Month rates until the Service is discontinued.

Effective November 30, 2023, unless specified to the contrary in their existing Service agreements, existing customers may not renew Term Payment Plans or term agreements for Service. In addition, no move, add, or change orders of any type will be accepted.

(T)

(T)

BELLSOUTH  
TELECOMMUNICATIONS  
TENNESSEE

ACCESS SERVICES TARIFF

Thirteenth Revised Page 8  
Cancels Twelfth Revised Page 8

ISSUED: December 9, 2022  
BY: Joelle Phillips, President - Tennessee  
Nashville, Tennessee

EFFECTIVE: January 1, 2023

## E7. SPECIAL ACCESS (A.K.A. BELLSOUTH SPA) SERVICE

### E7.2 Service Descriptions (Cont'd)

All services installed after the effective date of this Tariff will conform to the transmission specification standards contained in this Tariff or in the following Technical References for each category of service:

Voice Grade (a.k.a. BellSouth SPA DSO VG) <sup>2</sup>	TR-NPL-000335 PUB 41004, Table 4	(D)
Digital Data Access (a.k.a. BellSouth SPA DSO Digital Data) <sup>2</sup> For 2.4, 4.8, 9.6 and 56.0 Kbps	TR-NPL-000341 BellCore PUB 62310	
For 19.2 Kbps	INC. BULLETIN CB-INC-100	
For 64.0 Kbps	AT&T PUB 62310	
High Capacity (a.k.a. BellSouth SPA High Capacity)	TA-TSY -000342 TR-NPL-000054	
WATS Access Line (a.k.a. BellSouth SPA WATS Line) <sup>2</sup>	TR-NPL-000334	
Derived Data Channel (a.k.a. BellSouth SPA Derived Data Channel) <sup>2</sup> Service	BellSouth TR-73548 BellSouth TR-73548, Addendum 1	

#### E7.2.1 Reserved for Future Use

**Note 1:** *(DELETED)*

(T)

**Note 2:** Effective June 30, 2021, this Service will no longer be available for purchase by new or existing customers. In addition, requests to move, add, change, or renew existing service arrangements will not be accepted. Following the expiration of a customer's existing term agreement, service will be provided on a month-to-month basis at the applicable Monthly rates until the service is discontinued. The Company currently plans to discontinue this service on or after June 30, 2024.

BELLSOUTH  
TELECOMMUNICATIONS  
TENNESSEE

ACCESS SERVICES TARIFF

Fifth Revised Page 9  
Cancels Fourth Revised Page 9

ISSUED: March 7, 2019  
BY: Joelle Phillips, President - Tennessee  
Nashville, Tennessee

EFFECTIVE: March 28, 2019

**E7. SPECIAL ACCESS (A.K.A. BELLSOUTH SPA) SERVICE**

**E7.2 Service Descriptions (Cont'd)**

(D)

(D)

**E7.2.2 Reserved for Future Use**

(T)

(D)

(D)

BELLSOUTH  
TELECOMMUNICATIONS  
TENNESSEE

ACCESS SERVICES TARIFF

Fifth Revised Page 10  
Cancels Fourth Revised Page 10

ISSUED: June 9, 2021

EFFECTIVE: June 30, 2021

BY: Joelle Phillips, President - Tennessee  
Nashville, Tennessee

## E7. SPECIAL ACCESS (A.K.A. BELLSOUTH SPA) SERVICE

### E7.2 Service Descriptions (Cont'd)

#### E7.2.3 Voice Grade (a.k.a. BellSouth SPA DS0 VG)<sup>1</sup> Service

(C)

A. Basic Channel Description

A Voice Grade (a.k.a. BellSouth SPA DS0 VG) channel is a channel which provides voice frequency transmission capability in the nominal frequency range of 300 to 3000 Hz and may be terminated two-wire or four-wire. Voice Grade (a.k.a. BellSouth SPA DS0 VG) channels are provided between customer designated premises or between a customer designated premises and a Company Hub.

Voice Grade (a.k.a. BellSouth SPA DS0 VG) Channels are classified as Voice Grade/Voice or Voice Grade/Data depending on the suitability of the technical specification package requested by the customer. Voice Grade (a.k.a. BellSouth SPA DS0 VG) Technical Specification Packages 1, 2, 3, 4, 5, 7, 8, 9, 11 and 12 are suitable for Voice Grade/Voice. The Technical Specification Packages 6 and 10 are suitable for Voice Grade/Data Service.

B. Technical Specifications Packages

Parameter	Package VG-												
	1	2	3	4	5	6	7	8	9	10	11	12	
Attenuation Distortion	X	X	X	X	X	X	X	X	X	X	X	X	X
C-Message Noise	X	X	X	X	X	X	X	X	X	X	X	X	X
Echo Control	X	X	X		X		X	X			X	X	
Envelope Delay													
Distortion						X	X	X	X	X	X	X	X
Frequency Shift						X	X	X	X	X	X	X	X
Impulse Noise					X	X	X	X	X	X	X	X	X
Intermodulation													
Distortion						X	X	X	X	X	X	X	X
Loss Deviation	X	X	X	X	X	X	X	X	X	X	X	X	X
Phase Jitter						X	X	X	X	X	X	X	X
Signal-to-C													
Message Noise				X									
Signal-to-C													
Notch Noise					X	X	X	X	X	X	X	X	X

The technical specifications for these parameters are delineated in Technical Reference TR-NPL-000335 and associated Addendum.

**Note 1:** Effective June 30, 2021, this Service will no longer be available for purchase by new or existing customers. In addition, requests to move, add, change, or renew existing service arrangements will not be accepted. Following the expiration of a customer's existing term agreement, service will be provided on a month-to-month basis at the applicable Monthly rates until the service is discontinued. The Company currently plans to discontinue this service on or after June 30, 2024.

(N)  
|  
(N)

BELLSOUTH  
TELECOMMUNICATIONS  
TENNESSEE

ACCESS SERVICES TARIFF

Second Revised Page 10.1  
Cancels First Revised Page 10.1

ISSUED: June 9, 2021

EFFECTIVE: June 30, 2021

BY: Joelle Phillips, President - Tennessee  
Nashville, Tennessee

## E7. SPECIAL ACCESS (A.K.A. BELLSOUTH SPA) SERVICE

### E7.2 Service Descriptions (Cont'd)

#### E7.2.3 Voice Grade (*a.k.a. BellSouth SPA DS0 VG*)<sup>1</sup> Service (Cont'd)

(C)

##### C. Channel Interfaces

The following channel interfaces for Voice Grade (*a.k.a. BellSouth SPA DS0 VG*) service do not require signaling capability: DA, DB, DD, DE, DS, NO, PR and TF.

The following channel interfaces for Voice Grade (*a.k.a. BellSouth SPA DS0 VG*) service require signaling capability: AB, AC, CT, DX, EA, EB, EC, EX, GO, GS, LA, LB, LC, LO, LR, LS, RV and SF.

Compatible channel interfaces are set forth in Technical Reference TR-NPL-A and Associated Addendum following.

**Note 1:** Effective June 30, 2021, this Service will no longer be available for purchase by new or existing customers. In addition, requests to move, add, change, or renew existing service arrangements will not be accepted. Following the expiration of a customer's existing term agreement, service will be provided on a month-to-month basis at the applicable Monthly rates until the service is discontinued. The Company currently plans to discontinue this service on or after June 30, 2024.

(N)

(N)

BELLSOUTH  
TELECOMMUNICATIONS  
TENNESSEE

ACCESS SERVICES TARIFF

Fourth Revised Page 11  
Cancels Third Revised Page 11

ISSUED: June 9, 2021

EFFECTIVE: June 30, 2021

BY: Joelle Phillips, President - Tennessee  
Nashville, Tennessee

## E7. SPECIAL ACCESS (A.K.A. BELLSOUTH SPA) SERVICE

### E7.2 Service Descriptions (Cont'd)

#### E7.2.3 Voice Grade (a.k.a. BellSouth SPA DS0 VG)<sup>4</sup> Service (Cont'd)

D. Optional Features And Functions

1. Central Office Bridging
  - a. Voice Bridging<sup>1</sup> (two-wire and four-wire)
  - b. Data Bridging<sup>2</sup> (two-wire and four-wire)
  - c. Telephoto Bridging<sup>3</sup> (two-wire and four-wire)
  - d. Dataphone<sup>®</sup> Select-A-Station Bridging with sequential arrangement ports or addressable arrangement ports
  - e. Telemetry and Alarm Bridging
    - Split Band, Active Bridging
2. Reserved For Future Use
3. Conditioning

Conditioning provides more specific transmission characteristics for Voice Grade (a.k.a. BellSouth SPA DS0 VG) services. C-Type conditioning controls attenuation distortion and envelope delay distortion. Sealing Current helps maintain continuity on dry metallic<sup>4</sup> loops.

For two-point services, the parameters apply to each service. For multipoint services, the parameters apply to each mid link or end link. C-Type conditioning and D-Conditioning may be combined on the same service.

a. C-Type Conditioning

C-Type Conditioning is provided for the additional control of attenuation distortion and envelope delay distortion on data services. The attenuation distortion and envelope delay distortion specifications for C-Type Conditioning are:

Attenuation Distortion (Frequency Response) Relative to 1004 Hz

Frequency Range (Hz)	Variation (dB)
504 - 2804	-1.0 to + 3.0
304 - 3004	-2.0 to + 6.0

Envelope Delay Distortion

Frequency Range (Hz)	Variation (micro-seconds)
1004 - 2604	Less than 501
604 - 2604	LQI Less than 1501
504 - 2804	Less than 3001

Note 1: Voice Bridging is intended for use with VG2, 5 and 12. However, it may be used on VG6 and VG10 at a customers request.

Note 2: Data Bridging is intended for use with VG6 and VG10, however, it may be used on VG2, 5 and 12 at a customer's request.

Note 3: Telephoto Bridging is intended for use on VG11.

Note 4: Effective June 30, 2021, this Service will no longer be available for purchase by new or existing customers. In addition, requests to move, add, change, or renew existing service arrangements will not be accepted. Following the expiration of a customer's existing term agreement, service will be provided on a month-to-month basis at the applicable Monthly rates until the service is discontinued. The Company currently plans to discontinue this service on or after June 30, 2024.

BELLSOUTH  
TELECOMMUNICATIONS  
TENNESSEE

ACCESS SERVICES TARIFF

Fourth Revised Page 12  
Cancels Third Revised Page 12

ISSUED: June 9, 2021  
BY: Joelle Phillips, President - Tennessee  
Nashville, Tennessee

EFFECTIVE: June 30, 2021

**E7. SPECIAL ACCESS (A.K.A. BELLSOUTH SPA) SERVICE**

**E7.2 Service Descriptions (Cont'd)**

**E7.2.3 Voice Grade (a.k.a. BellSouth SPA DS0 VG)<sup>1</sup> Service (Cont'd)**

(C)

D. Optional Features And Functions (Cont'd)

3. Conditioning (Cont'd)

b. Improved Attenuation Distortion

Improved attenuation distortion is provided for additional control of attenuation distortion. The improved attenuation distortion specifications are:

Attenuation Distortion (Frequency Response) Relative to 1004 Hz

Frequency Range (Hz)	Variation (dB)
404-2804	-1.0 to +2.0
304-3004	-1.0 to +3.0
3004-3204	-2.0 to +6.0

c. Improved Envelope Delay Distortion

Improved envelope delay distortion is provided for additional control of envelope distortion. The improved envelope delay distortion specifications are:

Envelope Delay Distortion

Frequency Range (Hz)	Variation (micro-seconds)
1001-2604	Less than 101
604-2604	Less than 301
504-2804	Less than 3001

d. Sealing Current Conditioning

Sealing Current Conditioning is provided to help maintain continuity on dry metallic<sup>1</sup> loops. It is usually associated with four-wire DA or NO type channel interfaces.

(C)

4. Customer Specified Premises Receive Level

This option allows the customer to specify the receive level at the Point of Termination for a two or four wire interface at the customer's premises. For a two wire interface the customer must order an effective four wire channel and must specify a receive level within the range allowable for effective four wire transmission. For a four wire interface the receive level specified must be within the range allowable for four wire transmission. The customer can order improved termination for a wider range of receive levels. The ranges are delineated in Technical Reference TR-NPL-000335.

**Note 1:** Effective June 30, 2021, this Service will no longer be available for purchase by new or existing customers. In addition, requests to move, add, change, or renew existing service arrangements will not be accepted. Following the expiration of a customer's existing term agreement, service will be provided on a month-to-month basis at the applicable Monthly rates until the service is discontinued. The Company currently plans to discontinue this service on or after June 30, 2024.

(N)

(N)



BELLSOUTH  
TELECOMMUNICATIONS  
TENNESSEE

ACCESS SERVICES TARIFF

Third Revised Page 13  
Cancels Second Revised Page 13

ISSUED: June 9, 2021

EFFECTIVE: June 30, 2021

BY: Joelle Phillips, President - Tennessee  
Nashville, Tennessee

## E7. SPECIAL ACCESS (A.K.A. BELLSOUTH SPA) SERVICE

### E7.2 Service Descriptions (Cont'd)

#### E7.2.3 Voice Grade (*a.k.a. BellSouth SPA DS0 VG*)<sup>1</sup> Service (Cont'd)

(C)

##### D. Optional Features And Functions (Cont'd)

##### 5. Echo Control

##### a. ELEPL 2 (Equal Level Echo Path Loss)

On Effective Two-Wire Transmission at Four-Wire Point of Termination (applicable to each two-wire port): Provides for a fixed 600 ohm impedance, variable level range and simplex reversal. Company equipment is required at the customer's premises where this option is ordered. Improved Return Loss parameters are delineated in Technical Reference TR-NPL-000335.

##### b. Improved Return Loss

On Effective Two-Wire Transmission at Two-Wire Point of Termination: Provides for more stringent Echo Control specifications. In order for this option to be applicable, the transmission path must be four-wire at one Point of Termination (POT) and two-wire at the other POT. Placement of Company equipment may be required at the customer's premises with two-wire POT. The Improved Return Loss parameters are delineated in Technical Reference TR-NPL-000335.

##### 6. D-Conditioning

D-Conditioning provides transmission characteristics suitable for data communications. Specifically, D-Conditioning provides for the control of Signal to C-Notched Noise Ratio and intermodulation distortion. It is available for two-point services or multipoint services.

The signal to C-Notched Noise Ratio and intermodulation distortion parameters for D-Conditioning are:

- Signal to C-Notched Noise Ratio is equal to or greater than 32dB

- Intermodulation distortion:

- Signal to second order modulation products (R2) is equal to or greater than 38dB

- Signal to third order modulation products (R3) is equal to or greater than 42dB

When a service equipped with D-Conditioning is used for voice communications, the quality of the voice transmission may not be satisfactory. D-Conditioning transmission characteristics are described in Technical Reference TR-NPL-000335 under the name Data Capability.

##### 7. Telephoto Conditioning

Telephoto Conditioning provides transmission characteristics suitable for telephotographic communications. Specifically, Telephoto Conditioning is provided for the control of attenuation distortion and envelope delay distortion on telephotographic services. The attenuation distortion and envelope delay distortion parameters for Telephoto Conditioning are:

**Note 1:** Effective June 30, 2021, this Service will no longer be available for purchase by new or existing customers. In addition, requests to move, add, change, or renew existing service arrangements will not be accepted. Following the expiration of a customer's existing term agreement, service will be provided on a month-to-month basis at the applicable Monthly rates until the service is discontinued. The Company currently plans to discontinue this service on or after June 30, 2024.

(N)  
|  
(N)

BELLSOUTH  
TELECOMMUNICATIONS  
TENNESSEE

ACCESS SERVICES TARIFF

Fifth Revised Page 14  
Cancels Fourth Revised Page 14

ISSUED: June 9, 2021

EFFECTIVE: June 30, 2021

BY: Joelle Phillips, President - Tennessee  
Nashville, Tennessee

## E7. SPECIAL ACCESS (A.K.A. BELLSOUTH SPA) SERVICE

### E7.2 Service Descriptions (Cont'd)

#### E7.2.3 Voice Grade (*a.k.a. BellSouth SPA DS0 VG*)<sup>1</sup> Services (Cont'd)

(C)

##### D. Optional Features And Functions (Cont'd)

##### 7. Telephoto Conditioning (Cont'd)

###### Attenuation Distortion (1004 Hz Reference)

Frequency Range (Hz)	Variation (dB)
500 - 3000	- 0.5 to + 1.5
300 - 3200	- 1.0 to + 2.5

###### Envelope Delay Distortion

Frequency Range (Hz)	Variation (mcs)
1000 - 2600	Less than 111
800 - 2800	Less than 181

##### 8. Signaling Capability

Signaling Capability provides for the process by which one customer premises alerts another customer premises on the same service with which it wishes to communicate.

##### 9. Improved Termination

The Improved Termination option provides a fixed 600 ohm impedance, a variable level range and simplex reversal, when applicable, at the point of termination. Company equipment is required at the customer's premises when this option is ordered. The Improved Termination parameters are delineated in Technical Reference TR-NPL-000335.

##### 10. Simplex Reversal

The Simplex Reversal option physically turns over the simplex DC path presented at the four-wire point of termination when LO, LS, GO, GS, & DX signaling is provided at the point of termination.

##### 11. FlexServ<sup>®</sup> service (*a.k.a. BellSouth SPA Customer Reconfiguration*)

FlexServ<sup>®</sup> service (*a.k.a. BellSouth SPA Customer Reconfiguration*) provides the customer the ability to monitor and reconfigure Voice Grade (*a.k.a. BellSouth SPA DS0 VG*) service provided by the Company. FlexServ<sup>®</sup> service (*a.k.a. BellSouth SPA Customer Reconfiguration*) is described in E7.4.12 following. Charges for this feature are contained in E7.5.16. following.

Note 1: Effective June 30, 2021, this Service will no longer be available for purchase by new or existing customers. In addition, requests to move, add, change, or renew existing service arrangements will not be accepted. Following the expiration of a customer's existing term agreement, service will be provided on a month-to-month basis at the applicable Monthly rates until the service is discontinued. The Company currently plans to discontinue this service on or after June 30, 2024.

(N)  
|  
(N)

**E7. SPECIAL ACCESS (A.K.A. BELLSOUTH SPA) SERVICE**

**E7.2 Service Descriptions (Cont'd)**

**E7.2.3 Voice Grade (a.k.a. BellSouth SPA DS0 VG)<sup>1</sup> Services (Cont'd)**

(C)

D. Optional Features and Functions (Cont'd)

The following table shows the technical specifications packages with which the optional features and functions are available.

	Available with Technical Specifications Package VG-											
	1	2	3	4	5	6	7	8	9	10	11	12
C-Type Conditioning					X	X	X	X	X	X		
Improved Attenuation												
Distortion					X	X	X	X	X	X		
Improved Envelope												
Delay Distortion					X	X	X	X	X	X		
Central Office												
Bridging												
Capability												
Customer Specified												
Premises Receive												
Level												
D-Conditioning												
Echo Control												
Improved Return												
Loss												
ELEPL2												
FlexServ <sup>®</sup> Service (a.k.a. BellSouth SPA Customer Reconfiguration)												
Improved Termination												
Simplex Reversal												
Sealing Current												
Conditioning												
Signaling Capability												
Telephoto												
Conditioning												

E. Four-Wire/Two-Wire Conversions

When a customer requests that an effective four-wire channel be terminated with a two-wire channel interface at the customer designated premises, a four-wire to two-wire conversion is required. The rate for the conversion is included as part of the basic Local Channel rate.

**Note 1:** Effective June 30, 2021, this Service will no longer be available for purchase by new or existing customers. In addition, requests to move, add, change, or renew existing service arrangements will not be accepted. Following the expiration of a customer's existing term agreement, service will be provided on a month-to-month basis at the applicable Monthly rates until the service is discontinued. The Company currently plans to discontinue this service on or after June 30, 2024.

(N)  
|  
(N)

BELLSOUTH  
TELECOMMUNICATIONS  
TENNESSEE

ACCESS SERVICES TARIFF

Third Revised Page 15.1  
Cancels Second Revised Page 15.1

ISSUED: June 9, 2021

EFFECTIVE: June 30, 2021

BY: Joelle Phillips, President - Tennessee  
Nashville, Tennessee

## E7. SPECIAL ACCESS (A.K.A. BELLSOUTH SPA) SERVICE

### E7.2 Service Descriptions (Cont'd)

#### E7.2.3 Voice Grade (*a.k.a. BellSouth SPA DS0 VG*)<sup>1</sup> Services (Cont'd)

##### F. WATS Access Line (WAL) (*a.k.a. BellSouth SPA WATS Line*)<sup>1</sup> service

###### 1. Basic Channel Description

A WATS Access Line (*a.k.a. BellSouth SPA WATS Line*) service (WAL) provides a channel for voice frequency transmission capability. The service provides a connection between a customer designated premises and a WATS serving office associated with the closed end of *BellSouth SWA 8XX Toll Free Dailing Ten Digit Screening Service*, WATS (*a.k.a. BellSouth SPA WATS Line*) or similar services. It is provided for use with *BellSouth SWA FGD* in the originating and terminating direction and *BellSouth SWA FGA* and *BellSouth SWA FGB* in the terminating direction and *BellSouth SWA* arrangement features as set forth in Section 6 of Tariff FCC No. 1. The Company is currently unable to provide originating WATS (*a.k.a. BellSouth SPA WATS Line*) service through *BellSouth SWA FGA* and *BellSouth SWA FGB*. Such service will be provided as specified in 2. and 3. following.

The following shall apply to the Company's provision of WATS Access Line (*a.k.a. BellSouth SPA WATS Line*) service:

- a. When the end user's serving wire center is not a WATS serving office, channel mileage charges will apply for a WATS access line (*a.k.a. BellSouth SPA WATS Line*) extension (WALE) between the end user's serving wire center and the nearest WATS serving office.
- b. When a customer, other than AT&T, orders originating WATS Access Line (*a.k.a. BellSouth SPA WATS Line*) service and the end user's serving wire center is a WATS serving office which is not equipped with equal access, the Company will provide the WAL service to the nearest equal access WATS serving office by use of a WALE and the channel mileage charges for the WALE will be waived.
- c. When a customer other than AT&T orders originating WATS Access Line (*a.k.a. BellSouth SPA WATS Line*) service and the end user's serving wire center is not a WATS serving office and the nearest WATS serving office is not equipped with equal access, channel mileage charges for a WALE to the nearest WATS serving office will apply, as indicated in 1. preceding, but the Company will provide an additional WALE to the nearest WATS serving office equipped with equal access and the channel mileage charge for the additional WALE will be waived.

WATS Access Line (*a.k.a. BellSouth SPA WATS Line*) service is arranged for either originating calling or terminating calling. It is provided with either rotary dial or dual tone multifrequency address signaling and either loop start, ground start, E & M or reverse battery supervisory signaling. The choice of the type of signaling is at the option of the customer and subject to the technical limitations identified in the Technical Reference TR-NPL-000334. WATS Access Line (*a.k.a. BellSouth SPA WATS Line*) service is provided as an effective two-wire, an effective four-wire or a DS1 (i.e., 1.544 Mbps) transmission path. The DS1 WAL is only available as a trunk side termination on suitably equipped electronic switch, e.g., 1/1A ESS with Digital Carrier Termination (DCT) or DMS-100 with a Line Trunk Unit (LTU).

**Note 1:** Effective June 30, 2021, this Service will no longer be available for purchase by new or existing customers. In addition, requests to move, add, change, or renew existing service arrangements will not be accepted. Following the expiration of a customer's existing term agreement, service will be provided on a month-to-month basis at the applicable Monthly rates until the service is discontinued. The Company currently plans to discontinue this service on or after June 30, 2024.

(C)

(C)

(N)

(N)

BELLSOUTH  
TELECOMMUNICATIONS  
TENNESSEE

ACCESS SERVICES TARIFF

Second Revised Page 15.2  
Cancels First Revised Page 15.2

ISSUED: June 9, 2021

EFFECTIVE: June 30, 2021

BY: Joelle Phillips, President - Tennessee  
Nashville, Tennessee

## E7. SPECIAL ACCESS (A.K.A. BELLSOUTH SPA) SERVICE

### E7.2 Service Descriptions (Cont'd)

#### E7.2.3 Voice Grade (a.k.a. BellSouth SPA DS0 VG)<sup>1</sup> Service (Cont'd)

(C)

F. WATS Access Line (WAL) (a.k.a. BellSouth SPA WATS Line)<sup>1</sup> service (Cont'd)

(C)

2. Technical Specification Packages

Parameters	Package WAL -		
	1	2	3
Attenuation Distortion	X	X	
Bit error rate			X
C-Message Noise	X	X	
Echo Control	X	X	
Envelope Delay Distortion	X	X	
Frequency Shift	X	X	
Impulse Noise	X	X	
Intermodulation Distortion	X	X	
Loss Deviation	X	X	
Phase Jitter	X	X	
Signal-to-C Notch Noise	X	X	

The technical specifications are delineated in Technical Reference TR-NPL-000334.

3. The following interfaces are available with WAL Service:

LO, LS, DS, GO, GS, RV, EA, EB

Compatible channel interfaces are set forth in E7.3.5.I.

4. Optional Features and Functions

- a. Two-wire and four-wire Central Office bridging capability.
- b. Improved two-wire voice transmission specifications.
- c. Certain other options associated with WAL services such as WATS (a.k.a. BellSouth SPA WATS Line) Access Line Nonchargeable Termination Options and Common Switching Optional Features are available as defined in Section E6. preceding.
- d. One-way or Two-way Capability

**Note 1:** Effective June 30, 2021, this Service will no longer be available for purchase by new or existing customers. In addition, requests to move, add, change, or renew existing service arrangements will not be accepted. Following the expiration of a customer's existing term agreement, service will be provided on a month-to-month basis at the applicable Monthly rates until the service is discontinued. The Company currently plans to discontinue this service on or after June 30, 2024.

(N)

(N)

BELLSOUTH  
TELECOMMUNICATIONS  
TENNESSEE

ACCESS SERVICES TARIFF

Sixth Revised Page 16  
Cancels Fifth Revised Page 16

ISSUED: December 9, 2022

EFFECTIVE: January 1, 2023

BY: Joelle Phillips, President - Tennessee  
Nashville, Tennessee

## **E7. SPECIAL ACCESS (A.K.A. BELLSOUTH SPA) SERVICE**

### **E7.2 Service Descriptions (Cont'd)**

*E7.2.4 Reserved For Future Use*

(T)

(D)

BELLSOUTH  
TELECOMMUNICATIONS  
TENNESSEE

ACCESS SERVICES TARIFF

Fourth Revised Page 17  
Cancels Third Revised Page 17

ISSUED: December 9, 2022  
BY: Joelle Phillips, President - Tennessee  
Nashville, Tennessee

EFFECTIVE: January 1, 2023

## **E7. SPECIAL ACCESS (A.K.A. BELLSOUTH SPA) SERVICE**

### **E7.2 Service Descriptions (Cont'd)**

**E7.2.4 *Reserved For Future Use* (Cont'd)**

(T)

(D)

**E7.2.5 Reserved For Future Use**

(D)

BELLSOUTH  
TELECOMMUNICATIONS  
TENNESSEE

ACCESS SERVICES TARIFF

Sixth Revised Page 18  
Cancels Fifth Revised Page 18

ISSUED: June 9, 2021  
BY: Joelle Phillips, President - Tennessee  
Nashville, Tennessee

EFFECTIVE: June 30, 2021

**E7. SPECIAL ACCESS (A.K.A. BELLSOUTH SPA) SERVICE**

**E7.2 Service Descriptions (Cont'd)**

**E7.2.6 Reserved For Future Use**

**E7.2.7 Digital Data Access (a.k.a. BellSouth SPA DS0 Digital Data)<sup>1</sup> Service**

(C)

This service is a Flex-Price service and is regulated under terms and conditions as described in E2.1.14 of this Tariff.

A. Basic Channel Description

A Digital Data (a.k.a. BellSouth SPA DS0 Digital Data) channel is a channel for duplex four-wire transmission of synchronous serial data at the rate of 2.4, 4.8, 9.6, 19.2, 56 or 64 Kbps. The actual bit rate is a function of the channel interface selected by the customer. The channel provides a synchronous service with timing provided by the Company through the Company's facilities to the customer in the received bit stream. Digital Data (a.k.a. BellSouth SPA DS0 Digital Data) channels are only available via Company designated Digital Data (a.k.a. BellSouth SPA DS0 Digital Data) Hubs and are provided between customer designated premises or between a customer designated premises and a Company Digital Data (a.k.a. BellSouth SPA DS0 Digital Data) Hub.

A Hub termination charge applies per Digital Local Channel. This rate element covers the Hub functions (e.g., timing, testing) for the service.

Secondary Channel Capability (SCC) is a derived companion digital transmission path that is independent of the primary data path and operates at a substantially lower bit rate. This derived channel allows the customer to perform network management functions during the normal operation of the network. This diagnostics channel utilizes a portion of a customer's previously unavailable data bit stream allowing for the ability to remotely control and test the network and peripheral devices without taking the network out of service. Special customer equipment is necessary to utilize the benefits of the Secondary Channel. Customers not wishing to utilize this capability will not be impacted. Due to transmission equipment restrictions, Secondary Channel cannot be provided on 56 Kbps circuits that require the installation of loop repeater equipment for provision of service. Secondary Channel Capability, also, cannot be provided on 64 Kbps circuits, since all of the available bit stream will be used by the customer.

The customer will provide the Channel Service Unit-type equipment or other Network Channel Terminating Equipment associated with the Digital Data (a.k.a. BellSouth SPA DS0 Digital Data) channel at the customer premises. The interim program for interconnection of such equipment is set forth in Technical Reference PUB AS No. 1.

B. Technical Specifications Packages

Parameter	Package DA-					
	1	2	3	4	5	6
Error-Free Seconds	X	X	X	X	X	X

The Company will provide a channel capable of meeting a monthly average performance equal to or greater than 99.875 percent error-free seconds while the channel is in service, if it is measured through a CSU equivalent which is designed, manufactured, and maintained to conform with the specifications contained in Technical Reference PUB 62310.

Interface options and service objectives for Digital Data Access (a.k.a. BellSouth SPA DS0 Digital Data) service are delineated in Technical Reference TR-NPL-000341.

**Note 1:** Effective June 30, 2021, this Service will no longer be available for purchase by new or existing customers. In addition, requests to move, add, change, or renew existing service arrangements will not be accepted. Following the expiration of a customer's existing term agreement, service will be provided on a month-to-month basis at the applicable Monthly rates until the service is discontinued. The Company currently plans to discontinue this service on or after June 30, 2024.

(N)  
|  
(N)



BELLSOUTH  
TELECOMMUNICATIONS  
TENNESSEE

ACCESS SERVICES TARIFF

Ninth Revised Page 19  
Cancels Eighth Revised Page 19

ISSUED: June 9, 2021  
BY: Joelle Phillips, President - Tennessee  
Nashville, Tennessee

EFFECTIVE: June 30, 2021

**E7. SPECIAL ACCESS (A.K.A. BELLSOUTH SPA) SERVICE**

**E7.2 Service Descriptions (Cont'd)**

**E7.2.7 Digital Data Access (a.k.a. BellSouth SPA DS0 Digital Data)<sup>2</sup> Service (Cont'd)**

(C)

C. Channel Interfaces

The following channel interfaces (CIs) define the bit rates that are available for a Digital Data (a.k.a. BellSouth SPA DS0 Digital Data) channel:

CI	Bit Rate
DU-24(S) <sup>1</sup>	2.4 kbps
DU-48(S) <sup>1</sup>	4.8 kbps
DU-96(S) <sup>1</sup>	9.6 kbps
DU-19(S) <sup>1</sup>	19.2 kbps
DU-56(S) <sup>1</sup>	56.0 kbps
DU-64	64.0 kbps

Compatible channel interfaces are set forth in Technical Reference TR-NPL-000-341.

D. Optional Features and Functions

1. Central Office Bridging Capability
2. Secondary Channel Capability
3. FlexServ<sup>®</sup> service (a.k.a. BellSouth SPA Customer Reconfiguration)

FlexServ<sup>®</sup> service (a.k.a. BellSouth SPA Customer Reconfiguration) provides the customer the ability to monitor and reconfigure Digital Data Access (a.k.a. BellSouth SPA DS0 Digital Data) service provided by the Company. FlexServ<sup>®</sup> service (a.k.a. BellSouth SPA Customer Reconfiguration) is described in E7.4.12 following. Charges for this feature are contained in E7.5.16. following.

4.

The following table shows the technical specifications packages with which the optional features and functions are available.

	Available with Technical Specifications Package DA-					
	1	2	3	4	5	6
Central Office Bridging Capability	X	X	X	X	X	
Secondary Channel Capability	X	X	X	X	X	
FlexServ <sup>®</sup> Service (a.k.a. BellSouth SPA Customer Reconfiguration)	X	X	X	X	X	X

**Note 1:** (S) is an additional BellSouth designation for use when the optional Secondary Channel feature is required.

**Note 2:** Effective June 30, 2021, this Service will no longer be available for purchase by new or existing customers. In addition, requests to move, add, change, or renew existing service arrangements will not be accepted. Following the expiration of a customer's existing term agreement, service will be provided on a month-to-month basis at the applicable Monthly rates until the service is discontinued. The Company currently plans to discontinue this service on or after June 30, 2024.

(N)  
|  
(N)

BELLSOUTH  
TELECOMMUNICATIONS  
TENNESSEE

ACCESS SERVICES TARIFF

Tenth Revised Page 20  
Cancels Ninth Revised Page 20

ISSUED: June 9, 2021  
BY: Joelle Phillips, President - Tennessee  
Nashville, Tennessee

EFFECTIVE: June 30, 2021

## E7. SPECIAL ACCESS (A.K.A. BELLSOUTH SPA) SERVICE

### E7.2 Service Descriptions (Cont'd)

#### E7.2.7 Digital Data Access (*a.k.a. BellSouth SPA DS0 Digital Data*)<sup>2</sup> Service (Cont'd)

(C)

#### E7.2.8 High Capacity Service

This service is categorized as a Flex-Price service and is regulated under terms and conditions as described in E2.1.14 of this Tariff.

##### A. Basic Channel Description

A High Capacity (*a.k.a. BellSouth SPA High Capacity*) channel is a channel for the transmission of nominal 64.0 Kbps<sup>1, 2</sup> or 1.544, 3.152, 6.312 or 44.736 Mbps isochronous serial data. The actual bit rate is a function of the channel interface selected by the customer. High Capacity (*a.k.a. BellSouth SPA High Capacity*) channels are provided between customer designated premises or between a customer designated premises and a Company Hub.

(C)

The customer will provide the Network Channel Terminating Equipment associated with the High Capacity (*a.k.a. BellSouth SPA High Capacity*) channel at the customer's premises. The interim program for interconnection of such equipment is set forth in Technical Reference PUB AS No. 1.

##### B. Technical Specifications Packages

Parameters	Package HC-				
	0	1	1C	2	3
Error-Free Seconds			X		

A channel with technical specifications package HC1 will be capable of an error-free second performance of 98.75 percent over a continuous 24 hour period as measured at the 1.544 Mbps rate through a CSU equivalent which is designed, manufactured, and maintained to conform with the specifications contained in TR-NPL-000054

**Note 1:** Available only as a cross connect (through connection) of two 2.4, 4.8, 9.6, 19.2, 56.0 or 64.0 Kbps channels of two 1.544 Mbps facilities to a Digital Data (*a.k.a. BellSouth SPA DS0 Digital Data*) Hub(s). The customer must provide system and channel assignment data.

**Note 2:** Effective June 30, 2021, this Service will no longer be available for purchase by new or existing customers. In addition, requests to move, add, change, or renew existing service arrangements will not be accepted. Following the expiration of a customer's existing term agreement, service will be provided on a month-to-month basis at the applicable Monthly rates until the service is discontinued. The Company currently plans to discontinue this service on or after June 30, 2024.

(N)

(N)

BELLSOUTH  
TELECOMMUNICATIONS  
TENNESSEE

ACCESS SERVICES TARIFF

Seventh Revised Page 21  
Cancels Sixth Revised Page 21

ISSUED: June 9, 2021

EFFECTIVE: June 30, 2021

BY: Joelle Phillips, President - Tennessee  
Nashville, Tennessee

## E7. SPECIAL ACCESS (A.K.A. BELLSOUTH SPA) SERVICE

### E7.2 Service Descriptions (Cont'd)

#### E7.2.8 High Capacity (*a.k.a. BellSouth SPA High Capacity*) Service (Cont'd)

##### C. Channel Interfaces

The following channel interfaces (CIs) define the bit rates that are available for a High Capacity channel:

CI	Bit Rate
DS-15 <sup>1,2</sup>	1.544 Mbps (DS1)
DS-31	3.152 Mbps (DS1C)
DS-44	44.736 Mbps (DS3)
DS-63	6.312 Mbps (DS2)

(C)

Compatible channel interfaces are set forth in E7.3.1 following.

##### D. Optional Features and Functions

1.

##### 2. Clear Channel Capability

- a. Clear Channel Capability (CCC) is an arrangement that alters a DS1/1.544 Mbps signal with unconstrained information bits, to meet pulse density requirements outlined in TR-NPL-000054 and TA-TSY-000342. This will allow a customer to transport an all zero octet over a DS1/1.544 Mbps High Capacity (*a.k.a. BellSouth SPA DS1*) channel, providing an available combined maximum 1.536 Mbps data rate. This arrangement requires the customer signal at the channel interface to conform to Bipolar with 8 Zero Substitution (B8ZS) line code as described in TR-NPL-000054 and TA-TSY-000342.
- b. CCC is provided on DS1/1.544 Mbps High Capacity (*a.k.a. BellSouth SPA DS1*) channels between two customer designated premises or between a customer designated premises and a Company Hub location and is subject to the availability of facilities. This optional feature may be ordered at the same time the DS1/1.544 Mbps High Capacity (*a.k.a. BellSouth SPA DS1*) channel is ordered, or it may be ordered as an additional feature of an existing channel.
- c. When providing CCC via a DS3/44.736 Mbps High Capacity (*a.k.a. BellSouth SPA DS3*) channel, that DS3 channel must be designated, in Company records, as having Clear Channel Capability prior to the provisioning of a DS1/1.544 Mbps High Capacity (*a.k.a. BellSouth SPA DS1*) channel with CCC. Customers must agree to out-of-service periods required to add this feature to; 1) an existing DS1/1.544 Mbps High Capacity (*a.k.a. BellSouth SPA DS1*) channel or 2) a DS3/44.736 Mbps High Capacity (*a.k.a. BellSouth SPA DS3*) channel which transports a DS1/1.544 Mbps High Capacity (*a.k.a. BellSouth SPA DS1*) channel, to be optioned for B8ZS.

**Note 1:** A 64.0 Kbps channel is available as a channel(s) of a 1.544 Mbps facility to a Company Hub.

**Note 2:** Effective June 30, 2021, 64.0 Kbps will no longer be available for purchase by new or existing customers. In addition, requests to move, add, change, or renew existing service arrangements will not be accepted. Following the expiration of a customer's existing term agreement, service will be provided on a month-to-month basis at the applicable Monthly rates until the service is discontinued. The Company currently plans to discontinue this service on or after June 30, 2024.

(N)

(N)

BELLSOUTH  
TELECOMMUNICATIONS  
TENNESSEE

ACCESS SERVICES TARIFF

Fifth Revised Page 21.1  
Cancels Fourth Revised Page 21.1

ISSUED: December 9, 2022  
BY: Joelle Phillips, President - Tennessee  
Nashville, Tennessee

EFFECTIVE: January 1, 2023

## E7. SPECIAL ACCESS (A.K.A. BELLSOUTH SPA) SERVICE

### E7.2 Service Descriptions (Cont'd)

#### E7.2.8 High Capacity (a.k.a. BellSouth SPA High Capacity) Service (Cont'd)

##### D. Optional Features and Functions (Cont'd)

##### 3. Transfer Arrangement

An arrangement that affords the customer an additional measure of flexibility in the use of their access channel(s). The arrangement can be utilized to transfer a leg of a Special Access (a.k.a. BellSouth SPA) service to either a spare or working channel that terminates in either the same or a different customer premises. A key activated or dial up control service is required to operate the transfer arrangement. A spare channel, if required, is not included as part of the option.

##### 4. Channelization Interface

##### a. DS3 to DS1

An arrangement that channelizes a 44.736 Mbps channel to twenty-eight DS1 channels.

##### b. DS2 to DS1

An arrangement that channelizes a 6.312 Mbps channel to four DS1 channels.

##### c. DS1C to DS1

An arrangement that channelizes a 3.152 Mbps channel to two DS1 channels.

##### d. DS1 Basic Channelization System

An arrangement that channelizes a 1.544 Mbps channel to a maximum of twenty-four channels that may be used to activate both analog and digital services, e.g., voice grade, and digital data access service. A DS1 Basic Channelization System requires a Central Office Channel Interface for each channel of lesser capacity. (D)

##### e. DS0 Basic Channelization System<sup>1</sup>

An arrangement that channelizes a 64.0 Kbps channel to subspeeds of up to twenty 2.4 Kbps, ten 4.8 Kbps, or five 9.6 Kbps channels. A DS0 Basic Channelization System requires a Central Office Channel Interface for each channel of lesser capacity.

##### 5. Channel Interface

##### a. DS1 Level Central Office Channel Interface

An arrangement for the connection of DS1 (1.544 Mbps) channels to higher order DS3 (44.736 Mbps) services in Company central office locations.

##### b. DS1 Level Customer Channel Interface

An arrangement for the connection of DS1 (1.544 Mbps) channels to higher order DS3 (44.736 Mbps) services at customer locations.

##### c. DS0 Level Central Office Channel Interface<sup>1</sup>

An arrangement for the connection of VG/DS0 (2.4 - 64.0 Kbps) channels to higher order DS1 (1.544 Mbps) services in Company central office locations.

##### d. Subrate Level Central Office Channel Interface<sup>1</sup>

An arrangement for the connection of subrate (2.4 - 9.6 Kbps) channels to higher order DS0 (64.0 Kbps) services in Company central office locations.

**Note 1:** Effective June 30, 2021, this Service will no longer be available for purchase by new or existing customers. In addition, requests to move, add, change, or renew existing service arrangements will not be accepted. Following the expiration of a customer's existing term agreement, service will be provided on a month-to-month basis at the applicable Monthly rates until the service is discontinued. The Company currently plans to discontinue this service on or after June 30, 2024.

BELLSOUTH  
TELECOMMUNICATIONS  
TENNESSEE

ACCESS SERVICES TARIFF

Seventh Revised Page 22  
Cancels Sixth Revised Page 22

ISSUED: February 24, 1997  
BY: Joelle Phillips, President - Tennessee  
Nashville, Tennessee

EFFECTIVE: March 26, 1997

## E7. SPECIAL ACCESS (A.K.A. BELLSOUTH SPA) SERVICE (T)

### E7.2 Service Descriptions (Cont'd)

#### E7.2.8 High Capacity (*a.k.a. BellSouth SPA High Capacity*) Service (Cont'd)

##### D. Optional Features and Functions (Cont'd)

##### 6. FlexServ® service (*a.k.a. BellSouth SPA Customer Reconfiguration*) (T)

FlexServ® service (*a.k.a. BellSouth SPA Customer Reconfiguration*) provides the customer the ability to monitor and reconfigure High Capacity (*a.k.a. BellSouth SPA High Capacity*) service provided by the Company. FlexServ® service (*a.k.a. BellSouth SPA Customer Reconfiguration*) is described in E7.4.12 following. Charges for this feature are contained in E7.5.16. following. (T)

BELLSOUTH  
TELECOMMUNICATIONS  
TENNESSEE

ACCESS SERVICES TARIFF

Ninth Revised Page 22.1  
Cancels Eighth Revised Page 22.1

ISSUED: June 9, 2021  
BY: Joelle Phillips, President - Tennessee  
Nashville, Tennessee

EFFECTIVE: June 30, 2021

## E7. SPECIAL ACCESS (A.K.A. BELLSOUTH SPA) SERVICE

### E7.2 Service Descriptions (Cont'd)

#### E7.2.8 High Capacity (a.k.a. BellSouth SPA High Capacity) Service (Cont'd)

##### D. Optional Features and Functions (Cont'd)

The following table shows the technical specifications packages with which the optional features and functions are available.

	Available With Technical Specifications Package HC-				
	0	1	1C	2	3
Channelization:					
DS3 to DS1					X
DS2 to DS1				X	
DS1C to DS1			X		
DS1 Basic		X			
Channelization System					
DS0 Basic		X			
Channelization System <sup>1,2</sup>					
Transfer Arrangement				X	
Clear Channel Capability				X	
FlexServ <sup>®</sup> Service (a.k.a. BellSouth SPA Customer Reconfiguration)	X	X			

(C)

#### E7.2.9 Reserved For Future Use

#### E7.2.10 Reserved For Future Use

#### E7.2.11 Reserved For Future Use

#### E7.2.12 SMARTPath<sup>®</sup> Service (a.k.a. BellSouth SPA Shared Ring)

This service is categorized as a Flex-Price service and is regulated under terms and conditions as described in E2.1.14 of this Tariff.

##### A. Service Description

SMARTPath<sup>®</sup> service (a.k.a. BellSouth SPA Shared Ring) is a shared high capacity network service capable of providing a 1.544 Mbps transport link with high performance and reliability parameters and a level of redundancy/diversity designed to limit a single event from interrupting service. This service is available only in those locations within specified SMARTPath<sup>®</sup> service (a.k.a. BellSouth SPA Shared Ring) Areas which the Company determines can be incorporated into the SMARTPath<sup>®</sup> service (a.k.a. BellSouth SPA Shared Ring) network enabling the Company to provide the specified level of performance and reliability. For locations where a customer requests SMARTPath<sup>®</sup> service (a.k.a. BellSouth SPA Shared Ring) and facilities are not available, special construction charges will apply as set forth in Section E14. following. SMARTPath<sup>®</sup> service (a.k.a. BellSouth SPA Shared Ring) Areas are identified in the National Exchange Carrier (NECA) Tariff F.C.C. No. 4.

Note 1: Available only on 64.0 Kbps DDAS (a.k.a. BellSouth SPA DS0 Digital Data) service or on a DS1 (1.544 Mbps) channel with Clear Channel Capability to a Company hub.

Note 2: Effective June 30, 2021, this Service will no longer be available for purchase by new or existing customers. In addition, requests to move, add, change, or renew existing service arrangements will not be accepted. Following the expiration of a customer's existing term agreement, service will be provided on a month-to-month basis at the applicable Monthly rates until the service is discontinued. The Company currently plans to discontinue this service on or after June 30, 2024.

(N)  
|  
(N)

BELLSOUTH  
TELECOMMUNICATIONS  
TENNESSEE

ACCESS SERVICES TARIFF

Fifth Revised Page 22.1.1  
Cancels Fourth Revised Page 22.1.1

ISSUED: November 10, 2021

EFFECTIVE: December 1, 2021

BY: Joelle Phillips, President - Tennessee  
Nashville, Tennessee

## E7. SPECIAL ACCESS (A.K.A. BELLSOUTH SPA) SERVICE

### E7.2 Service Descriptions (Cont'd)

#### E7.2.12 SMARTPath® Service (a.k.a. BellSouth SPA Shared Ring) (Cont'd)

##### A. Service Description (Cont'd)

SMARTPath® service (a.k.a. BellSouth SPA Shared Ring) provides a transport link between a customer designated premises where the network is accessed and (1) another customer designated premises, in the same SMARTPath® service (a.k.a. BellSouth SPA Shared Ring) Area or (2) a serving wire center in the same SMARTPath® service (a.k.a. BellSouth SPA Shared Ring) Area for connection to (a) DS1 Basic Channelization, FlexServ® service (a.k.a. BellSouth SPA Customer Reconfiguration), SMARTRing® service (a.k.a. BellSouth Dedicated Ring), or DS3 (a.k.a. BellSouth SPA DS3) service as provided in Section E7. of this Tariff, or (b) a SMARTPath® service (a.k.a. BellSouth SPA Shared Ring) Area Junction of another SMARTPath® service (a.k.a. BellSouth SPA Shared Ring) area in the same Metropolitan Area. (C)

The technical specifications and standard network interfaces for SMARTPath® service (a.k.a. BellSouth SPA Shared Ring) are contained in BellSouth Telecommunications, Inc. Technical Reference Publication 73575. This publication is available from BellSouth Telecommunications, Inc. Documentation Operations, North W5A1, 3535 Colonnade Parkway, Birmingham, Alabama 35243.

DS1s carried over Synchronous Optical Network (SONET) transport systems can incur phase transients as a result of pointer adjustments. In some instances timing problems could surface in customer's equipment with Stratum 3 or better clocks. This may result in the customer's clock disqualifying its synchronization reference, generating an alarm and/or selecting an alternate reference or entering holdover. To insure proper operation, channelized DS1 circuits must comply with Bellcore Technical Advisory, TA-NWT-000436, Digital Synchronization Network Plan, and ANSI T1.101-1994. When timing is taken from a Company transported DS1, the customer's equipment must be capable of accommodating SONET pointer adjustments.

##### B. Performance Objectives

ANSI T1.403-1989 Extended SuperFrame Format (ESF) is required on all circuits in order to assure performance objectives. The performance objectives for SMARTPath® service (a.k.a. BellSouth SPA Shared Ring) are as follows:

1. Meet or exceed 99.99 percent Circuit Availability on a monthly basis. This objective applies except where a customer's equipment is disconnected and/or inoperative.
2. Meet or exceed 99.95 percent Error Free Seconds on a monthly basis.
3. Meet or exceed .009 percent Severely Errored Seconds on a monthly basis.

##### C. Performance Guarantees

The performance guarantees for SMARTPath® service (a.k.a. BellSouth SPA Shared Ring) are as follows:

1. Guaranteed service installation - the Company will meet negotiated due date or credit an amount equal to the nonrecurring charge according to the Service Installation Guarantee described in E2.4.9 preceding.
2. Service Continuity - in the event of primary facility failure, service is guaranteed to switch to an alternate facility path in sixty (60) seconds or less. Failure to meet this guarantee will result in a credit as described in E2.4.4.B.7. preceding, where the trouble is in the network.

**Note 1:** Effective on or after December 1, 2021, neither new nor existing customers will be permitted to purchase new SMARTRing Service (Service). In addition, (A) Service Payment Plans greater than 12-months in length will no longer be available; and (B) requests to move, add, change, upgrade, or downgrade existing service arrangements will not be accepted, with the following exceptions: (1) existing customers will be permitted to modify their existing Service and will be able to add new circuits to their existing Service, but will not be permitted to add new nodes in any locations; and (2) any such new circuits will be subject to the customer's existing term payment plan or term agreement for the Service to which they are added. Following the expiration of a customer's existing term agreement, Service will be provided on a month-to-month basis at the applicable Month-to-Month rates until the Service is discontinued. (N)

Effective November 30, 2023, unless specified to the contrary in their existing Service agreements, existing customers may not renew Term Payment Plans or term agreements for Service. In addition, no move, add, or change orders of any type will be accepted. (N)

BELLSOUTH  
TELECOMMUNICATIONS  
TENNESSEE

ACCESS SERVICES TARIFF

Second Revised Page 22.1.2  
Cancels First Revised Page 22.1.2

ISSUED: October 10, 2014  
BY: Joelle Phillips, President - Tennessee  
Nashville, Tennessee

EFFECTIVE: October 31, 2014

## **E7. SPECIAL ACCESS (A.K.A. BELLSOUTH SPA) SERVICE**

### **E7.2 Service Descriptions (Cont'd)**

**E7.2.13 Reserved for Future Use**

(T)

**E7.2.14 Reserved for Future Use**

(D)

(T)



BELLSOUTH  
TELECOMMUNICATIONS  
TENNESSEE

ACCESS SERVICES TARIFF

Third Revised Page 22.2  
Cancels Second Revised Page 22.2

ISSUED: November 30, 2001

EFFECTIVE: December 31, 2001

BY: Joelle Phillips, President - Tennessee  
Nashville, Tennessee

## **E7. SPECIAL ACCESS (A.K.A. BELLSOUTH SPA) SERVICE**

### **E7.2 Service Descriptions (Cont'd)**

**E7.2.14 (DELETED) (Cont'd)**

(D)

BELLSOUTH  
TELECOMMUNICATIONS  
TENNESSEE

ACCESS SERVICES TARIFF

Eighth Revised Page 22.3  
Cancels Seventh Revised Page 22.3

ISSUED: November 10, 2021  
BY: Joelle Phillips, President - Tennessee  
Nashville, Tennessee

EFFECTIVE: December 1, 2021

## E7. SPECIAL ACCESS (A.K.A. BELLSOUTH SPA) SERVICE

### E7.2 Service Descriptions (Cont'd)

#### E7.2.15 Derived Data Channel (a.k.a. BellSouth SPA Derived Data Channel)<sup>1</sup> Service

A. Basic Service Description

Derived Data Channel (a.k.a. BellSouth SPA Derived Data Channel) service (DDCS) provides full-duplex asynchronous or synchronous data transmission utilizing data over voice<sup>1</sup> and subrate multiplexing<sup>1</sup> technology. DDCS (a.k.a. BellSouth SPA Derived Data Channel) provides simultaneous data and voice transmissions over the customer's existing two-wire local exchange facility. A derived data channel is provided between the customer's premises and the customer's serving wire center.

At the customer's serving wire center the data/voice terminating equipment provides subrate multiplexing<sup>1</sup> into a standard DS0-B interface for a group composed of a maximum of twenty derived data channels. The customer's derived data channel must be associated with a DS0-B interface. This association requires coordination between the subscriber of the derived data channel and the subscriber of the DS0-B interface. An interoffice channel is provided for interconnection of the subrate multiplexed<sup>1</sup> DS0-B interface to the serving wire center of a customer designated premises.

DDCS (a.k.a. BellSouth SPA Derived Data Channel) is provided subject to the availability of appropriate network facilities and equipment and subject to the transmission limitations of the facilities and equipment used by the Company.

The customer will be responsible for selecting his own Customer Premises Equipment (CPE). CPE must be compatible with the Company provided terminating equipment at the serving wire center.

B. Channel Interfaces

The following channel interface (CI) is available for DDCS (a.k.a. BellSouth SPA Derived Data Channel).

CI	Bit Rate
2DV5.BA	2.4 Kbps, Digital Data Over Voice <sup>1</sup>

Compatible channel interface specifications are contained in BellSouth Technical Reference Publication 73548 for data/voice multiplexing equipment and BellSouth Technical Reference 73548, Addendum 1, for the DS0-B interface. These publications are available from the Information Exchange Manager, BellSouth Telecommunications, Inc., Regional Documentations Coordinator, 20th Floor, 600 North 19th Street, Birmingham, Alabama 35203.

#### E7.2.16 SMARTRing<sup>®2</sup> service (a.k.a. BellSouth Dedicated Ring)

(C)

A. Self-healing Multi-nodal Alternate Route Topology Ring

1. SMARTRing<sup>®</sup> service (a.k.a. BellSouth Dedicated Ring) is a dedicated, high capacity, network designed to provide increased reliability and functionality via a self-healing ring topology between multiple customer designated locations and Company Central Offices where facilities can be made available as determined by the Company. This network consists of fiber routed through local, alternate central office, internodal and/or interoffice channel facilities that transmit DS1, DS3, STS-1, OC-3, OC-12, OC-48 and/or 1000 Mbps channel services simultaneously over primary and alternate paths between customer designated locations and Company Central Offices. This ring topology will continually monitor DS1, DS3, STS-1, OC-3, OC-12, OC-48 and/or 1000 Mbps service quality, detect any failure within the system, and automatically self-heal around a point of failure to ensure the flow of DS1, DS3, STS-1, OC-3, OC-12, OC-48 and/or 1000 Mbps services between locations within the network.

**Note 1:** Effective June 30, 2021, this Service will no longer be available for purchase by new or existing customers. In addition, requests to move, add, change, or renew existing service arrangements will not be accepted. Following the expiration of a customer's existing term agreement, service will be provided on a month-to-month basis at the applicable Monthly rates until the service is discontinued. The Company currently plans to discontinue this service on or after June 30, 2024.

**Note 2:** Effective on or after December 1, 2021, neither new nor existing customers will be permitted to purchase new SMARTRing Service (Service). In addition, (A) Service Payment Plans greater than 12-months in length will no longer be available; and (B) requests to move, add, change, upgrade, or downgrade existing service arrangements will not be accepted, with the following exceptions: (1) existing customers will be permitted to modify their existing Service and will be able to add new circuits to their existing Service, but will not be permitted to add new nodes in any locations; and (2) any such new circuits will be subject to the customer's existing term payment plan or term agreement for the Service to which they are added. Following the expiration of a customer's existing term agreement, Service will be provided on a month-to-month basis at the applicable Month-to-Month rates until the Service is discontinued.

(N)

Effective November 30, 2023, unless specified to the contrary in their existing Service agreements, existing customers may not renew Term Payment Plans or term agreements for Service. In addition, no move, add, or change orders of any type will be accepted.

(N)

ISSUED: November 10, 2021

EFFECTIVE: December 1, 2021

BY: Joelle Phillips, President - Tennessee  
Nashville, Tennessee**E7. SPECIAL ACCESS (A.K.A. BELLSOUTH SPA) SERVICE****E7.2 Service Descriptions (Cont'd)****E7.2.16 SMARTRing<sup>®2</sup> service (a.k.a. BellSouth Dedicated Ring) (Cont'd)**

(C)

**A. Self-healing Multi-nodal Alternate Route Topology Ring (Cont'd)**

2. SMARTRing<sup>®</sup> service (a.k.a. BellSouth Dedicated Ring) is available at OC-1, OC-3, OC-3+ OC-12, OC-48, OC-48+, OC-192 and OC-192+ capacities.
3. OC-1 SMARTRing<sup>®</sup> service (a.k.a. BellSouth Dedicated Ring) is available only in Overlay Ring Arrangements riding the customer's host OC-12, OC-48, or OC-48+ SMARTRing<sup>®</sup> service (a.k.a. BellSouth Dedicated Ring). The OC-1 SMARTRing<sup>®</sup> service (a.k.a. BellSouth Dedicated Ring) shares the transport of its host SMARTRing<sup>®</sup> service (a.k.a. BellSouth Dedicated Ring). OC-1 SMARTRing<sup>®</sup> service (a.k.a. BellSouth Dedicated Ring) provides an equivalent capacity of 28 DS1s or one STS-1. When an OC-1 SMARTRing<sup>®</sup> service (a.k.a. BellSouth Dedicated Ring) overlays an OC-12, OC-48, or OC-48+ SMARTRing<sup>®</sup> service (a.k.a. BellSouth Dedicated Ring), an OC-1 channel interface is required.
4. OC-3 SMARTRing<sup>®</sup> service (a.k.a. BellSouth Dedicated Ring) is available as an individual service or in an Overlay Ring Arrangement riding the customer's host OC-12, OC-48, OC-48+, OC-192, or OC-192+ SMARTRing<sup>®</sup> service (a.k.a. BellSouth Dedicated Ring). OC-3 SMARTRing<sup>®</sup> service (a.k.a. BellSouth Dedicated Ring) provides an equivalent capacity of 3 DS3s, or any combination thereof not to exceed an OC-3 capacity.  
Channel Interface Reallocation allows the customer to reallocate STS-1, DS3 and/or DS1 capacities to OC-3 nodes subsequent to the initial configuration of an OC-3 ring.
5. OC-3+ SMARTRing<sup>®(1)</sup> service (a.k.a. BellSouth Dedicated Ring) is available as an individual service, or in combination with OC-12 SMARTRing<sup>®</sup> service (a.k.a. BellSouth Dedicated Ring), or in an Overlay Ring Arrangement riding the customer's host OC-48, OC-48+, OC-192, or OC-192+ SMARTRing<sup>®</sup> service (a.k.a. BellSouth Dedicated Ring). OC-3+ SMARTRing<sup>®</sup> service (a.k.a. BellSouth Dedicated Ring) provides an equivalent OC-3 capacity, not to exceed 3 DS3s at each node, with a maximum ring capacity of 12 DS3s, not to exceed an OC-12 ring capacity.
6. When a customer orders OC-3+ SMARTRing<sup>®</sup> service (a.k.a. BellSouth Dedicated Ring) in combination with OC-12 SMARTRing<sup>®</sup> service (a.k.a. BellSouth Dedicated Ring), capacity and channel interface availability at each Customer Node and Central Office Node location is determined by the size node ordered by the customer.
7. OC-12 SMARTRing<sup>®</sup> service (a.k.a. BellSouth Dedicated Ring) is available as an individual service, or in combination with OC-3+ SMARTRing<sup>®</sup> service (a.k.a. BellSouth Dedicated Ring), or in an Overlay Ring Arrangement riding the customer's host OC-48, OC-48+, OC-192 or OC-192+ SMARTRing<sup>®</sup> service (a.k.a. BellSouth Dedicated Ring). OC-12 SMARTRing<sup>®</sup> service (a.k.a. BellSouth Dedicated Ring) provides an equivalent capacity of 12 DS3s.
8. OC-48 SMARTRing<sup>®</sup> service (a.k.a. BellSouth Dedicated Ring) is available as an individual service, or in an Overlay Ring Arrangement riding the customer's host OC-192 or OC-192+ SMARTRing<sup>®</sup> service (a.k.a. BellSouth Dedicated Ring), or with overlaying rings in capacities of OC-1, OC-3, OC-3+ and/or OC-12. OC-48 SMARTRing<sup>®</sup> service (a.k.a. BellSouth Dedicated Ring) provides an equivalent capacity of 48 DS3s.
9. OC-48+ SMARTRing<sup>®</sup> service (a.k.a. BellSouth Dedicated Ring) is available as an individual bi-directional service, or in an Overlay Ring Arrangement riding the customer's host OC-192 SMARTRing<sup>®</sup> service (a.k.a. BellSouth Dedicated Ring), or with overlaying rings in capacities of OC-1, and/or OC-3. It provides equivalent capacity of 24 DS3s between consecutive node locations on the ring. The maximum capacity of the OC-48+ SMARTRing<sup>®</sup> service (a.k.a. BellSouth Dedicated Ring) is determined by the number of Customer and Central Office nodes on the ring.

(M)

**Note 1:** Effective June 26, 2015, the Company will accept only disconnect orders for OC-3+ SMARTRing service (a.k.a. BellSouth SPA Dedicated Ring), including orders associated with existing service. Move, add or change orders will no longer be accepted.

(C)

**Note 2:** Effective on or after December 1, 2021, neither new nor existing customers will be permitted to purchase new SMARTRing Service (Service). In addition, (A) Service Payment Plans in length will no longer be available; and (B) requests to move, add, change, upgrade, or downgrade existing service arrangements will not be accepted, with the following exceptions: (1) existing customers will be permitted to modify their existing Service and will be able to add new circuits to their existing Service, but will not be permitted to add new nodes in any locations; and (2) any such new circuits will be subject to the customer's existing term payment plan or term agreement for the Service to which they are added. Following the expiration of a customer's existing term agreement, Service will be provided on a month-to-month basis at the applicable Month-to-Month rates until the Service is discontinued.

(N)

Effective November 30, 2023, unless specified to the contrary in their existing Service agreements, existing customers may not renew Term Payment Plans or term agreements for Service. In addition, no move, add, or change orders of any type will be accepted.

(N)

BELLSOUTH  
TELECOMMUNICATIONS  
TENNESSEE

ACCESS SERVICES TARIFF

Fifth Revised Page 22.4.1  
Cancels Fourth Revised Page 22.4.1

ISSUED: November 10, 2021  
BY: Joelle Phillips, President - Tennessee  
Nashville, Tennessee

EFFECTIVE: December 1, 2021

## KEY. SPECIAL ACCESS (A.K.A. BELLSOUTH SPA) SERVICE

### E7.2 Service Descriptions (Cont'd)

#### E7.2.16 SMARTRing<sup>7</sup> service (a.k.a. BellSouth Dedicated Ring) (Cont'd)

##### A. Self-healing Multi-nodal Alternate Route Topology Ring (Cont'd)

- 10. OC-192 SMARTRing<sup>®</sup> service (a.k.a. BellSouth Dedicated Ring) is available as an individual service, or with overlaying rings in capacities of OC-3, OC-3+, OC-12, OC-48 and /or OC-48+. OC-192 SMARTRing<sup>®</sup> service (a.k.a. BellSouth Dedicated Ring) provides an equivalent capacity of 192 DS3s. (M1)
- 11. OC-192+ SMARTRing<sup>®</sup> service (a.k.a. BellSouth Dedicated Ring) is available as an individual bi-directional service, or with overlaying rings in capacities of OC-3, OC-3+, OC-12 and /or OC-48. It provides equivalent capacity of 96 DS3s between consecutive node locations on the ring. The maximum capacity of the OC-192+ SMARTRing<sup>®</sup> service (a.k.a. BellSouth Dedicated Ring) is determined by the number of Customer and Central Office nodes on the ring. (M1)
- 12. SMARTRing service (a.k.a. BellSouth Dedicated Ring) Channel Interfaces are available as follows:

<u>Channel Interfaces</u>	<u>Nodes</u>							
	<u>OC-1</u>	<u>OC-3</u>	<u>OC-3+</u>	<u>OC-12</u>	<u>OC-48</u>	<u>OC-48+</u>	<u>OC-192</u>	<u>OC-192+</u>
DS1	Yes	Yes	Yes	No <sup>1</sup>	No <sup>1</sup>	No <sup>1</sup>	No <sup>1</sup>	No <sup>1</sup>
DS3	No	Yes	Yes	Yes	Yes	Yes	Yes	Yes
STS-1	Yes	Yes	Yes	Yes	Yes	Yes	Yes	Yes
OC-1 <sup>2</sup>	No	No	No	Yes	Yes	Yes	No	No
OC-3	No	No	No	Yes	Yes	Yes	Yes	Yes
OC-12	No	No	No	No	Yes	Yes	Yes	Yes
28 DS1 Channel System (DS3)	No	Yes	Yes	Yes	Yes	Yes	Yes	Yes
28 DS1 Channel System (STS-1)	No	Yes	Yes	Yes	Yes	Yes	Yes	Yes
1000 Mbps	No	No	No	No	Yes <sup>3</sup>	Yes <sup>3</sup>	Yes	Yes
100 Mbps BellSouth Metro Ethernet <sup>6</sup> Backbone <sup>4</sup>	No	No	No	Yes	Yes	Yes	Yes	Yes
1000 Mbps BellSouth Metro Ethernet <sup>6</sup> Backbone	No	No	No	No	Yes	Yes	Yes	Yes
Fractional 1000 Mbps at 150 Mbps, 300 Mbps or 450 Mbps BellSouth Metro Ethernet <sup>6</sup> Backbone <sup>5</sup>	No	Yes	Yes	Yes	Yes	Yes	Yes	Yes
Fractional 1000 Mbps at 600 Mbps BellSouth Metro Ethernet <sup>6</sup> Backbone <sup>5</sup>	No	No	No	No	Yes	Yes	Yes	Yes

**Note 1:** DS1 interfaces are available via OC-1, OC-3, and OC-3+ Overlay Ring Arrangements or 28 DS1 Channel Systems only.

**Note 2:** OC-1 interfaces are only available for use with OC-1 Overlay Ring Arrangements.

**Note 3:** 1000 Mbps interfaces are only available for rings installed after November 28, 2003. 1000 Mbps transport channel interfaces do not contain any monitoring capability above the physical layer.

**Note 4:** 100 Mbps BellSouth Metro Ethernet Backbone interfaces are further defined regarding the number of STS-1s utilized in conjunction with the interface.

**Note 5:** Interface availability is based on equipment capability.

**Note 6:** Effective on or after August 22, 2021, this Service will no longer be available for purchase by new or existing customers. In addition, requests to move, add, change, or renew existing service arrangements will not be accepted. Following the expiration of a customer's existing term agreement, service will be provided on a month-to-month basis at the applicable Monthly rates until the service is discontinued. The Company currently plans to discontinue this service on or after March 31, 2023.

**Note 7:** Effective on or after December 1, 2021, neither new nor existing customers will be permitted to purchase new SMARTRing Service (Service). In addition, (A) Service Payment Plans greater than 12-months in length will no longer be available; and (B) requests to move, add, change, upgrade, or downgrade existing service arrangements will not be accepted, with the following exceptions: (1) existing customers will be permitted to modify their existing Service and will be able to add new circuits to their existing Service, but will not be permitted to add new nodes in any locations; and (2) any such new circuits will be subject to the customer's existing term payment plan or term agreement for the Service to which they are added. Following the expiration of a customer's existing term agreement, Service will be provided on a month-to-month basis at the applicable Month-to-Month rates until the Service is discontinued. (N)

Effective November 30, 2023, unless specified to the contrary in their existing Service agreements, existing customers may not renew Term Payment Plans or term agreements for Service. In addition, no move, add, or change orders of any type will be accepted. (N)

M1 Material appearing on this page previously appeared on page(s) 22.4 of this section.

M2 Material previously appearing on this page now appears on page(s) 22.5 of this section.

BELLSOUTH  
TELECOMMUNICATIONS  
TENNESSEE

ACCESS SERVICES TARIFF

Fifth Revised Page 22.5  
Cancels Fourth Revised Page 22.5

ISSUED: November 10, 2021  
BY: Joelle Phillips, President - Tennessee  
Nashville, Tennessee

EFFECTIVE: December 1, 2021

**E7. SPECIAL ACCESS (A.K.A. BELLSOUTH SPA) SERVICE**

**E7.2 Service Descriptions (Cont'd)**

**E7.2.16 SMARTRing' service (a.k.a. BellSouth Dedicated Ring) (Cont'd)**

(C)

**A. Self-healing Multi-nodal Alternate Route Topology Ring (Cont'd)**

13. SMARTRing service (a.k.a. BellSouth Dedicated Ring) Overlay Ring Arrangements are available as follows:

(M)

	Overlaying SMARTRing service (a.k.a. BellSouth Dedicated Ring)			Host SMARTRing service (a.k.a. BellSouth Dedicated Ring)	
	OC-12	OC-48	OC-48+	OC-192	OC-192+
OC-1	X	X	X	X	X
OC-3	X	X	X	X	X
OC-3+		X	X	X	X
OC-12		X	X	X	X
OC-48				X	X
OC-48+					X

14. SMARTRing service (a.k.a. BellSouth Dedicated Ring) is connectible at Company Central Offices to any 44.736 Mbps and/or 1.544 Mbps services as provided in Section E7. of this Tariff. Rates and charges for such other services are as set forth in the applicable sections of this tariff for such other services.

15. Shared Network Arrangements will not be provided with SMARTRing service (a.k.a. BellSouth Dedicated Ring) at the ring level. Shared Network Arrangements as defined in E2.6 preceding apply to DS1 channel interfaces only.

The customer must provide suitable floor space, controlled environment, and source of non-switched suitable power to support this service.

16. Where the customer provides two separate entrance facility cable routes for SMARTRing service (a.k.a. BellSouth Dedicated Ring), the primary and alternate entrance facilities will be separate and will enter the customer node over such different routes. When the customer requests a connection at a Customer Node via two local channels and Company facilities do not exist for the second Local Channel, the Company may provide an equivalent second Local Channel via an existing alternate route. When facilities become available for the second Local Channel, the Company may rearrange the alternate route at any time.

17. When the distance between nodes on a SMARTRing service (a.k.a. BellSouth SPA Dedicated Ring) is such that optical signal regeneration is required, then regeneration equipment will be provided at no additional charge to the customer to assure proper operation of the service. In some cases regeneration will be provided via SONET Add/Drop equipment called a Regeneration Node. A Regeneration Node does not contain the capability to add or drop services. Accordingly, FlexServ service (a.k.a. BellSouth SPA Customer Reconfiguration) Customer Network Management may not be ordered with a Regeneration Node, however, a customer may monitor a Regeneration Node via the FlexServ service (a.k.a. BellSouth SPA Customer Reconfiguration) Customer Network Management Surveillance option when a customer has established surveillance for a ring. Regeneration Node Surveillance is provided as a part of the charges associated with the customer's ring level FlexServ service (a.k.a. BellSouth SPA Customer Reconfiguration) Customer Network Management Surveillance. Regeneration Node and Regeneration Node Surveillance, as applicable, will appear on a customer's records as non-rated USOC(s), as follows:

	USOC
Regeneration Node, all ring capacities, non-rated	SHNRD
Regeneration Node Surveillance, all ring capacities, non-rated	SHNRS

**Note 1:** Effective on or after December 1, 2021, neither new nor existing customers will be permitted to purchase new SMARTRing Service (Service). In addition, (A) Service Payment Plans greater than 12-months in length will no longer be available; and (B) requests to move, add, change, upgrade, or downgrade existing service arrangements will not be accepted, with the following exceptions: (1) existing customers will be permitted to modify their existing Service and will be able to add new circuits to their existing Service, but will not be permitted to add new nodes in any locations; and (2) any such new circuits will be subject to the customer's existing term payment plan or term agreement for the Service to which they are added. Following the expiration of a customer's existing term agreement, Service will be provided on a month-to-month basis at the applicable Month-to-Month rates until the Service is discontinued.

(N)

Effective November 30, 2023, unless specified to the contrary in their existing Service agreements, existing customers may not renew Term Payment Plans or term agreements for Service. In addition, no move, add, or change orders of any type will be accepted.

(N)

BELLSOUTH  
 TELECOMMUNICATIONS  
 TENNESSEE  
 ISSUED: November 10, 2021  
 BY: Joelle Phillips, President - Tennessee  
 Nashville, Tennessee

ACCESS SERVICES TARIFF

First Revised Page 22.5.0.1  
 Cancels Original Page 22.5.0.1

EFFECTIVE: December 1, 2021

**E7. SPECIAL ACCESS (A.K.A. BELLSOUTH SPA) SERVICE**

**E7.2 Service Descriptions (Cont'd)**

**E7.2.16 SMARTRing<sup>1</sup> service (a.k.a. BellSouth Dedicated Ring) (Cont'd)**

**A. Self-healing Multi-nodal Alternate Route Topology Ring (Cont'd)**

18. Effective February 16, 2007, Shared Node Interconnection is available, based on equipment capability, whereby two SMARTRing service arrangements belonging to the same customer may share a node in a central office that is common to both rings. Shared Node Interconnection capability is available based on equipment capability. With Shared Node Interconnection, one of the rings (i.e., the larger capacity ring) is considered the Primary Ring and the other ring is considered the Secondary Ring. Primary Rings may be an OC-12, OC-48 or an OC-192 ring. A Secondary Ring is always a lower capacity ring than that of the Primary Ring. The various Shared Node Interconnection service arrangements that are available are as follows:

<b>Shared Node Interconnection Primary Ring Capacity</b>	<b>Shared Node Interconnection Secondary Ring Capacity Available For Use With Primary Rings</b>			
	OC-3	OC-12	OC-48	OC-48+
OC-12	X			
OC-48	X	X		
OC-192	X	X	X	X

With Shared Node Interconnection, the Primary Ring shall have a Central Office Node and the Secondary Ring shall have a Shared Node Interconnection Central Office Node in the central office associated with the ring interconnection. For the Secondary Ring, a Shared Node Interconnection Central Office Node is considered toward meeting the three node minimum requirement for the Secondary Ring. This shared node will utilize capacity of the Primary Ring node, based on the size of the Secondary Ring, and will count toward the capacity the customer has available at the location. Should the customer require more capacity at a shared node central office location than is available on the Primary Ring node, then additional billable service components will be required.

Only one Shared Node Interconnection arrangement is available for an individual Central Office Node on a Primary Ring.

Reconfiguration is not allowed at central office nodes that are configured for Shared Node Interconnection.

**B. Technical Specifications Packages**

1. The compatibility requirements, technical specifications, and generic requirements for SMARTRing service (a.k.a. Bellsouth Dedicated Ring) terminated at the customers designated locations are referenced in Technical Reference ANSI T1.404-1994, ANSI T1.403-1989 and ANSI T1.105-1991.
2. DS3 interface combinations and technical specifications are referenced in Bellcore TR-INS-000342.
3. DS1 interface combinations and technical specifications are referenced in Bellcore TR-NPL-000054.
4. STS-1, OC-1, OC-3, and OC-12 interface combinations and technical specifications are referenced in BellSouth Telecommunications, Inc. Technical Reference TR-73582.
5. These self-healing multi-nodal DS3 high capacity (a.k.a. BellSouth SPA DS3) service channels have a long term performance objective of 99.5 percent error-free seconds and a severely errored second (SES) objective of less than 0.009 percent SES when the circuit is available. Self-healing multi-nodal DS1 high capacity (a.k.a. BellSouth SPA DS1) service channels have a long term performance objective of 99.95 percent error-free seconds.

**E7.2.17 Reserved For Future Use**

**Note 1:** Effective on or after December 1, 2021, neither new nor existing customers will be permitted to purchase new SMARTRing Service (Service). In addition, (A) Service Payment Plans greater than 12-months in length will no longer be available; and (B) requests to move, add, change, upgrade, or downgrade existing service arrangements will not be accepted, with the following exceptions: (1) existing customers will be permitted to modify their existing Service and will be able to add new circuits to their existing Service, but will not be permitted to add new nodes in any locations; and (2) any such new circuits will be subject to the customer's existing term payment plan or term agreement for the Service to which they are added. Following the expiration of a customer's existing term agreement, Service will be provided on a month-to-month basis at the applicable Month-to-Month rates until the Service is discontinued. Effective November 30, 2023, unless specified to the contrary in their existing Service agreements, existing customers may not renew Term Payment Plans or term agreements for Service. In addition, no move, add, or change orders of any type will be accepted.

BELLSOUTH  
TELECOMMUNICATIONS  
TENNESSEE

ACCESS SERVICES TARIFF

Fifth Revised Page 22.5.1  
Cancels Fourth Revised Page 22.5.1

ISSUED: July 30, 2021

EFFECTIVE: August 22, 2021

BY: Joelle Phillips, President - Tennessee  
Nashville, Tennessee

## E7. SPECIAL ACCESS (A.K.A. BELLSOUTH SPA) SERVICE

### E7.2 Service Descriptions (Cont'd)

#### E7.2.18 BellSouth Metro Ethernet Service<sup>2</sup>

(C)

- A. BellSouth Metro Ethernet service is a high-speed packet transport that is based on Ethernet transmission parameters. BellSouth Metro Ethernet service provides various transport capabilities that range from 2 Mbps through 1 Gbps with capabilities for basic, premium and virtual arrangements that may be used to meet individual customer needs.
- B. BellSouth Metro Ethernet service signals meet IEEE 802.3, 802.3u, or 802.3z standards. BellSouth Metro Ethernet service also uses 802.1Q VLAN tagging and stacking for certain service configurations contained herein. Technical requirements for interfaces with customer premises equipment (CPE) are contained in ANSI/IEEE 802.3-2002 Specifications. BellSouth Metro Ethernet service interface specifications are set forth in BellSouth Technical Reference TR-73632. Technical limitations associated with provisioning 2 Mbps, 4 Mbps and 8 Mbps BellSouth Metro Ethernet Connections based upon distance from the customer's premises to serving wire center and equipment configurations exist and are also set forth in TR-73632.
- C. The rates and charges set forth in E7.5.22 following for BellSouth Metro Ethernet service provide for the furnishing of service in certain metropolitan areas where suitable Company facilities are available. In locations where BellSouth Metro Ethernet service is not available, special construction charges may apply.
- D. A LAN (local area network) is a communications network spanning a limited geographical area. A LAN connects computers and other peripheral equipment for data communications purposes within a building or campus environment.
- E. A VLAN (virtual local area network) is a logical grouping of Metro Ethernet connections that allows data transmission between such connections to occur as if all connections are on the same physical LAN.
- F. Metro Ethernet is a service where Local Area Networks (LANs) send bi-directional Ethernet traffic to other LANs on an Ethernet Wide Area Network (WAN). Ethernet is one of the most widely deployed LAN/WAN standards. BellSouth Metro Ethernet service supports IEEE Standard 802.3, 802.3u and 802.3z transmission standards.
- G. A Metro Ethernet Customer Network is defined as the set of interconnected Metro Ethernet connections assigned to the same VLAN within the BellSouth core network. Premium Connections that include the Q-Forwarding optional feature described in O. following and Virtual Connections that include the VLAN Aggregation optional feature described in P. following may be part of more than one Metro Ethernet Customer Network.
- H. A Basic BellSouth Metro Ethernet service Connection provides 2 Mbps, 4 Mbps, 8 Mbps, 10 Mbps, 100 Mbps and 1 Gbps Ethernet capabilities that are a part of a BellSouth Metro Ethernet service network within a metropolitan area. Basic BellSouth Metro Ethernet service is a best effort service with service capabilities that are affected by overall traffic on the Basic BellSouth Metro Ethernet service network and is suitable for data transmission only.
- A Basic BellSouth Metro Ethernet service connection operating at any of these speeds is capable of interconnecting with other Basic BellSouth Metro Ethernet service Connections that are operating at any of these speeds in the same metropolitan area.
- A Basic BellSouth Metro Ethernet service connection provides data channel transport that connects customer premises<sup>1</sup> that are 10 miles or less in distance from the BellSouth Metro Ethernet service wire center associated with the Basic BellSouth Metro Ethernet service Connection. Customer locations<sup>1</sup> greater than 10 miles from the Basic BellSouth Metro Ethernet service wire center also require BellSouth Metro Ethernet service Additional Mileage charges.

**Note 1:** And as alternatively set forth in E7.4.32.A.5. and 6. following.

**Note 2:** Effective on or after August 22, 2021, this Service will no longer be available for purchase by new or existing customers. In addition, requests to move, add, change, or renew existing service arrangements will not be accepted. Following the expiration of a customer's existing term agreement, service will be provided on a month-to-month basis at the applicable Monthly rates until the service is discontinued. The Company currently plans to discontinue this service on or after March 31, 2023.

(N)  
|  
(N)

BELLSOUTH  
TELECOMMUNICATIONS  
TENNESSEE

ACCESS SERVICES TARIFF

Fourth Revised Page 22.5.1.1  
Cancels Third Revised Page 22.5.1.1

ISSUED: July 30, 2021

EFFECTIVE: August 22, 2021

BY: Joelle Phillips, President - Tennessee  
Nashville, Tennessee

## E7. SPECIAL ACCESS (A.K.A. BELLSOUTH SPA) SERVICE

### E7.2 Service Descriptions (Cont'd)

#### E7.2.18 BellSouth Metro Ethernet Service (Cont'd)<sup>3</sup>

(C)

- J.** A Premium BellSouth Metro Ethernet service Connection provides 2 Mbps, 4 Mbps, 8 Mbps, 10 Mbps, 20 Mbps, 50 Mbps, 100 Mbps, 250 Mbps, 500 Mbps and 900 Mbps Ethernet capabilities that are a part of a BellSouth Metro Ethernet service network within a metropolitan area. Premium BellSouth Metro Ethernet service provides the ability to order Ethernet Service with improved service characteristics to meet customer needs regarding the assurance of bandwidth availability.

Premium BellSouth Metro Ethernet service provides customer capabilities to assure service characteristics via ordering a Committed Bandwidth (CBW). A CBW is the minimum bandwidth across the BellSouth Metro Ethernet service network within a metropolitan area between a customer's Premium BellSouth Metro Ethernet service locations.

Premium BellSouth Metro Ethernet service Connections are available with "Fixed" and "Burst" capabilities unless specified otherwise<sup>1</sup>. With the Fixed arrangement, Premium BellSouth Metro Ethernet service Connections will have the bandwidth ordered (e.g., 10 Mbps) available across the BellSouth Metro Ethernet service network. With the Burst arrangement, Premium BellSouth Metro Ethernet service Connections will have the ability to send burst of data above their CBW rate, if network capacity *and facilities are* available. For example, a 10 Mbps, a 20 Mbps and a 50 Mbps Connection may Burst up to 100 Mbps, while a 100 Mbps, a 250 Mbps and a 500 Mbps Connection may Burst up to 1 Gbps.

A Premium BellSouth Metro Ethernet service Connection operating at any of these speeds is capable of interconnecting with other Premium BellSouth Metro Ethernet service Connections that are operating at any of these speeds in the same metropolitan area.

A Premium BellSouth Metro Ethernet service Connection provides data channel transport that connects customer premises<sup>2</sup> that are 10 miles or less in distance from the BellSouth Metro Ethernet service wire center associated with the Premium BellSouth Metro Ethernet service Connection. Customer locations<sup>2</sup> greater than 10 miles from the Premium BellSouth Metro Ethernet service wire center also require BellSouth Metro Ethernet service Additional Mileage charges.

**Note 1:** Premium Connections at 2 Mbps, 4 Mbps, 8 Mbps and 900 Mbps are available only as Fixed arrangements (i.e., "Burst" capability is not available).

**Note 2:** And is alternatively set forth in E7.4.32.A.5. and 6. following.

**Note 3:** Effective on or after August 22, 2021, this Service will no longer be available for purchase by new or existing customers. In addition, requests to move, add, change, or renew existing service arrangements will not be accepted. Following the expiration of a customer's existing term agreement, service will be provided on a month-to-month basis at the applicable Monthly rates until the service is discontinued. The Company currently plans to discontinue this service on or after March 31, 2023.

(N)  
|  
(N)



BELLSOUTH  
TELECOMMUNICATIONS  
TENNESSEE

ACCESS SERVICES TARIFF

Fifth Revised Page 22.5.2  
Cancels Fourth Revised Page 22.5.2

ISSUED: July 30, 2021

EFFECTIVE: August 22, 2021

BY: Joelle Phillips, President - Tennessee  
Nashville, Tennessee

## E7. SPECIAL ACCESS (A.K.A. BELLSOUTH SPA) SERVICE

### E7.2 Service Descriptions (Cont'd)

#### E7.2.18 BellSouth Metro Ethernet Service (Cont'd)<sup>2</sup>

(C)

K.

- L. A Virtual BellSouth Metro Ethernet Service Connection provides 2 Mbps, 4 Mbps, 8 Mbps, 10 Mbps, 20 Mbps, 50 Mbps, 80 Mbps, 100 Mbps, 200 Mbps, 300 Mbps, 450 Mbps, 600 Mbps, 750 Mbps and 900 Mbps Ethernet capabilities that are a part of a BellSouth Metro Ethernet Service network within a metropolitan area. Virtual BellSouth Metro Ethernet Service provides the ability to order Ethernet Service where a single customer connection can support multiple applications with varying Quality of Service (QoS) features and Classes of Service.

Virtual BellSouth Metro Ethernet Service provides customer capabilities to support different Classes of Service (CoS) (i.e., Real-Time, Interactive, Business Critical and Best Effort as described in E7.2.18.T) over the same Connection and offers customers increased flexibility to match bandwidth to their real needs for voice/data/video applications on each Connection. The customer orders the percentage of their Virtual BellSouth Metro Ethernet Service Connection bandwidth that will be allocated for each class of service.

For each Virtual Connection, the customer's bandwidth will be limited to the fixed speed associated with each CoS level specified in the CoS profile selected for the Virtual Connection.

A Virtual BellSouth Metro Ethernet Service Connection operating at any of these speeds is capable of interconnecting with other Virtual BellSouth Metro Ethernet Service Connections that are operating at any of these speeds in the same metropolitan area.

A Virtual BellSouth Metro Ethernet Service Connection provides data channel transport that connects customer premises<sup>1</sup> that are 10 miles or less in distance from the BellSouth Metro Ethernet Service wire center associated with the Virtual BellSouth Metro Ethernet Service Connection. Customer locations<sup>1</sup> greater than 10 miles from the Virtual BellSouth Metro Ethernet Service wire center also require BellSouth Metro Ethernet Service Additional Mileage charges.

**Note 1:** And as alternatively set forth in E7.4.32.A.5. *and 6.* following.

**Note 2:** Effective on or after August 22, 2021, this Service will no longer be available for purchase by new or existing customers. In addition, requests to move, add, change, or renew existing service arrangements will not be accepted. Following the expiration of a customer's existing term agreement, service will be provided on a month-to-month basis at the applicable Monthly rates until the service is discontinued. The Company currently plans to discontinue this service on or after March 31, 2023.

(N)

(N)

BELLSOUTH  
TELECOMMUNICATIONS  
TENNESSEE

ACCESS SERVICES TARIFF

Fourth Revised Page 22.5.2.1  
Cancels Third Revised Page 22.5.2.1

ISSUED: July 30, 2021

EFFECTIVE: August 22, 2021

BY: Joelle Phillips, President - Tennessee  
Nashville, Tennessee

## E7. SPECIAL ACCESS (A.K.A. BELLSOUTH SPA) SERVICE

### E7.2 Service Descriptions (Cont'd)

#### E7.2.18 BellSouth Metro Ethernet Service (Cont'd)<sup>2</sup>

(C)

- M.** BellSouth Metro Ethernet service Additional Mileage charges associated with a BellSouth Metro Ethernet service Connection apply when the total distance from the customer premises<sup>1</sup> to the BellSouth Metro Ethernet service wire center associated with the service serving the customer premises<sup>1</sup> is greater than 10 miles in length. The additional mileage is measured in airline miles from the customer premises<sup>1</sup> to the BellSouth Metro Ethernet service wire center associated with the BellSouth Metro Ethernet service. Fractions of miles will be considered as a whole mile.

BellSouth Metro Ethernet service Additional Mileage charges apply to Basic, Premium and Virtual BellSouth Metro Ethernet service based on the service's speed and the total distance associated with the data channel. The BellSouth Metro Ethernet service Additional Mileage Charge is based on the mileage band the total data channel mileage falls into. For example, a data channel that is 30 miles in length would be charged the additional mileage rate for the greater than 25 mile through 35 mile band.

- N.** Priority Plus is an optional feature available to customers with Premium BellSouth Metro Ethernet service. Priority Plus provides the customer with the ability to prioritize their traffic in accordance with a predefined hardware queue model approach. With this option, customers will assign priority values to their data and higher-priority data will be transmitted first. Priority Plus service traffic is limited to a small subset of the total Committed Bandwidth (CBW) traffic and is marked for expedited handling within the Metro Ethernet Service. Customers that desire Priority Plus must establish it for all of their Premium BellSouth Metro Ethernet service Connections within that Metro Ethernet Customer Network.

- O.** Q-Forwarding is an optional feature available to customers with Premium BellSouth Metro Ethernet service. Q-Forwarding provides VLAN aggregation across a common physical connection. This feature supports customer aggregation of traffic from multiple Metro Ethernet Customer Networks (referred to as VLANS). This aggregated traffic can be transported back to a central location and across a common Metro Ethernet Service Connection (referred to as the "aggregation" connection). Q-Forwarding utilizes IEEE 802.1Q VLAN Tagging procedures.

While Q-Forwarding is available with BellSouth Premium Metro Ethernet Connections at 2 Mbps, 4 Mbps and 8 Mbps, this feature is subject to technical limitations set forth in Technical Reference 73632 when used with these speed connections.

With Q-Forwarding, special technical considerations set forth in Technical Reference 73632 must be taken into account to determine the customer's CBW across their BellSouth Metro Ethernet Network.

The Q-Forwarding Service Establishment Charge is a charge to provision a Premium Metro Ethernet Connection with the Q-Forwarding feature and identify it as an "aggregation" connection.

The Q-Forwarding Network Assignment Charge is a charge to provision each Metro Ethernet Customer Network to the Q-Forwarding "aggregation" connection. The Q-Forwarding Network Assignment Charge applies for each VLAN connected to the Q-Forwarding "aggregation" connection.

- P.** VLAN Aggregation is an optional feature available to customers with Virtual BellSouth Metro Ethernet Service. VLAN Aggregation provides VLAN aggregation across a common physical connection. This feature supports customer aggregation of traffic from multiple Metro Ethernet Customer Networks (referred to as VLANS) comprised of Virtual Connections. This aggregated traffic can be transported back to a central location and across a common Virtual Metro Ethernet Service Connection (referred to as the "aggregation" connection). VLAN Aggregation utilizes IEEE 802.1Q VLAN Tagging procedures.

While VLAN Aggregation is available with BellSouth Virtual Metro Ethernet Connections at 2 Mbps, 4 Mbps and 8 Mbps, this feature is subject to technical limitations set forth in Technical Reference 73632 when used with these speed connections.

The VLAN Aggregation Service Establishment Charge is a charge to provision a Virtual Metro Ethernet Connection with this feature and identify it as an "aggregation" connection.

The VLAN Aggregation Network Assignment Charge is a charge to provision each Virtual Ethernet Customer Network to the "aggregation" connection. The VLAN Aggregation Network Assignment Charge applies for each VLAN connected to the "aggregation" connection.

**Note 1:** And as alternatively set forth in E7.4.32.A.5. following.

**Note 2:** Effective on or after August 22, 2021, this Service will no longer be available for purchase by new or existing customers. In addition, requests to move, add, change, or renew existing service arrangements will not be accepted. Following the expiration of a customer's existing term agreement, service will be provided on a month-to-month basis at the applicable Monthly rates until the service is discontinued. The Company currently plans to discontinue this service on or after March 31, 2023.

(N)  
|  
(N)

BELLSOUTH  
TELECOMMUNICATIONS  
TENNESSEE

ACCESS SERVICES TARIFF

Fourth Revised Page 22.5.3  
Cancels Third Revised Page 22.5.3

ISSUED: July 30, 2021

EFFECTIVE: August 22, 2021

BY: Joelle Phillips, President - Tennessee  
Nashville, Tennessee

## E7. SPECIAL ACCESS (A.K.A. BELLSOUTH SPA) SERVICE

### E7.2 Service Descriptions (Cont'd)

#### E7.2.18 BellSouth Metro Ethernet Service (Cont'd)<sup>1</sup>

(C)

- Q.** *Customer Network Management (CNM)* - Metro Ethernet Reporting is an optional feature available to customers with Premium or Virtual BellSouth Metro Ethernet service. *CNM* - Metro Ethernet Reporting provides customers a view into their BellSouth Metro Ethernet service network via the use of a web interface and security card. *CNM* - Metro Ethernet Reporting provides alarm surveillance, service level agreement reporting and performance reporting for the various network components that comprise the customer's BellSouth Metro Ethernet service network. This feature is only available to customers purchasing Premium or Virtual BellSouth Metro Ethernet service.

Customers who subscribe to *CNM* - Metro Ethernet Reporting must monitor their entire BellSouth Metro Ethernet Network. The *CNM* - Metro Ethernet Reporting Charge is applicable for each Premium or Virtual Metro Ethernet Service Connection.

The *CNM* - Metro Ethernet Reporting Service Establishment Charge is a nonrecurring charge that applies to initially establish a new Metro Ethernet Service customer account. A customer with an existing Metro Ethernet Reporting customer account from another BellSouth jurisdiction may re-use that customer account.

All customers purchasing *CNM* - Metro Ethernet Reporting must have a web interface that will allow the customer to access and monitor their network via the web. Each web interface provides for one concurrent access. Additional concurrent accesses will require additional web interfaces. An initial web interface (Web Interface Charge - First) is provided with the initial establishment of a customer account. A monthly charge and a nonrecurring charge are applicable for each additional web interface requested for a customer account (Web Interface Charge – Each Additional).

A security card is required to access a web interface. Each security card can only be used for a single concurrent access and can be associated with only one web interface. A Security Card Charge will apply for the initial and additional cards requested and for the issuance of additional cards to replace lost, damaged or expired cards. A nonrecurring charge is applicable per security card requested.

- R.** BellSouth Metro Ethernet service Customer networks comprised of Premium Connections or Virtual Connections with *CNM* - Metro Ethernet Reporting are provided Service Level Agreements (SLAs) for the Company's repair and performance commitments for this service. Credits are provided for missed commitments on such service. The specific SLA commitments and credits applicable are set forth in E7.4.32.C. following for Premium Connections and in E7.4.32.D. for Virtual Connections.
- S.** Subsequent to its initial installation, a customer may request to reconfigure or change a BellSouth Metro Ethernet service Connection. The Service Reconfiguration Charge or System Reconfiguration Charge will be the nonrecurring charge applicable for such a request; the appropriate nonrecurring charge will be based upon the reconfiguration or change requested, as specifically described and set forth in E7.4.32 following.
- T.** For each Virtual BellSouth Metro Ethernet Connection the customer must decide the mix of applications that will be supported on that Connection, the CoS mix that Virtual Connection must support, and the percentage of bandwidth to be assigned for each CoS (i.e., build a CoS profile for each Virtual Connection). The customer's bandwidth will be limited to the fixed speed associated with each CoS level. Therefore, total bandwidth available to support transmission of a specific CoS will depend upon the size of the customer's Connection and the specific CoS percentage the customer selected for that Connection.

A customer may request a single CoS or up to four CoS to build the CoS Profile for a Virtual Connection. The customer determines the percentage bandwidth each CoS selected should be of the total Virtual Connection's bandwidth. The sum of the percentages for each CoS selected for a Virtual Connection must equal 100%. Additionally, the combined CoS bandwidth percentages selected in a customer's CoS Profile for Real-Time CoS plus Interactive CoS may not exceed 50%, except where the customer selects the 70% Real-Time CoS bandwidth percentage and has no Interactive traffic.

A customer may select different CoS profiles for different Virtual Connections that share the same network VLAN, or Virtual Connection network arrangement. However, technical limitations exist as discussed in TR-73632 that limit the total number of different CoS profiles that can be utilized in a single Virtual Connection network arrangement.

Note 1: Effective on or after August 22, 2021, this Service will no longer be available for purchase by new or existing customers. In addition, requests to move, add, change, or renew existing service arrangements will not be accepted. Following the expiration of a customer's existing term agreement, service will be provided on a month-to-month basis at the applicable Monthly rates until the service is discontinued. The Company currently plans to discontinue this service on or after March 31, 2023.

(N)

(N)

BELLSOUTH  
TELECOMMUNICATIONS  
TENNESSEE

ACCESS SERVICES TARIFF

First Revised Page 22.5.3.1  
Cancels Original Page 22.5.3.1

ISSUED: July 30, 2021

EFFECTIVE: August 22, 2021

BY: Joelle Phillips, President - Tennessee  
Nashville, Tennessee

## E7. SPECIAL ACCESS (A.K.A. BELLSOUTH SPA) SERVICE

### E7.2 Service Descriptions (Cont'd)

#### E7.2.18 BellSouth Metro Ethernet Service (Cont'd)<sup>2</sup>

(C)

T. (Cont'd)

The CoS and percentage bandwidth selected for a Virtual Connection will define the applications that can be supported and its Quality of Service (QoS) attributes such as traffic priority, latency, packet loss rate, etc. QoS attributes are defined for each CoS. Each Virtual Connection will support Ethernet traffic representing one or more applications and CoS. Virtual Connections support the four following CoS:

- Real-Time<sup>1</sup>: This CoS supports VoIP applications. The Real-Time CoS is supported by a low latency queue. The Low Latency Queuing (LLQ) feature in the Ethernet network is used for support of the Real-Time CoS.
- Interactive<sup>1</sup>: This CoS supports interactive Video applications. The Interactive CoS is policed to a maximum bandwidth.
- Business Critical: This CoS supports mission-critical business data applications. These applications tend to be data specific and may include medical imaging, electronic funds transfer, medical records transfer, etc.
- Best Effort: This CoS is the default CoS for all other traffic that is not defined as Business Critical, Real-Time or Interactive. Traffic that does not match the other CoS will be mapped as Best Effort. Traffic with the Best Effort CoS will have the lowest priority on the network and will support lower priority data applications, such as email and file transfer protocol (FTP).

Each customer packet from a Virtual Connection will be classified and assigned to a specific CoS by methods identified in TR-73632.

**Note 1:** The combined CoS bandwidth percentages selected in a customer's Virtual Connection CoS profile for Real-Time CoS plus Interactive CoS may not exceed 50%, except where the customer selects the 70% Real-Time CoS bandwidth percentage and has no Interactive traffic.

**Note 2:** Effective on or after August 22, 2021, this Service will no longer be available for purchase by new or existing customers. In addition, requests to move, add, change, or renew existing service arrangements will not be accepted. Following the expiration of a customer's existing term agreement, service will be provided on a month-to-month basis at the applicable Monthly rates until the service is discontinued. The Company currently plans to discontinue this service on or after March 31, 2023.

(N)

(N)

ISSUED: July 30, 2021

EFFECTIVE: August 22, 2021

BY: Joelle Phillips, President - Tennessee  
Nashville, Tennessee**E7. SPECIAL ACCESS (A.K.A. BELLSOUTH SPA) SERVICE****E7.2 Service Descriptions (Cont'd)****E7.2.18 BellSouth Metro Ethernet Service (Cont'd)<sup>2</sup>**

(C)

- U. Automatic Protection Switching (APS) is an optional feature available, except as specified otherwise herein, to customers with a Basic, Premium or Virtual BellSouth Metro Ethernet Service Connection of 10 Mbps or higher<sup>1</sup>. The APS feature provides customers with the option of having data channel (i.e., facilities from the customer premises to the BellSouth Metro Ethernet Service wire center) survivability through the use of a secondary transport path that is diverse from the path provided with their primary Metro Ethernet Connection. This secondary transport path (i.e., data channel) is provided for a specific Metro Ethernet Connection (i.e., the primary) with the selection of the APS feature which then provides the customer with complete path protection. However, APS is not available for a 2 Mbps, 4 Mbps or 8 Mbps Connection.

With APS, the primary Metro Ethernet Connection's data channel is monitored for threshold violations or path failures with a fail-over to the secondary data channel path provided via the APS feature. The APS data channel is checked periodically to ensure its availability if a failure of the primary Metro Ethernet Connection's data channel occurs.

APS may be ordered as a structurally diverse transport path (Structural Protection) or a route diverse transport path (Route Protection).

Structural Protection APS is defined as the APS facility and the primary Metro Ethernet Connection facility being in separate sheaths in separate structures located along the same route (e.g., underground/underground, buried/underground, aerial/underground, aerial/buried, buried/buried, and aerial/aerial), or along different routes at the Telephone Company's discretion

Route Protection APS is defined as the APS facility being in a separate sheath within alternate underground, aerial or direct buried structures that are run along separate physical paths from the facilities associated with the primary Metro Ethernet Connection. No precise distance separation is specified between the paths; although the separation is sufficient to preclude one disruptive event from affecting both routes.

The APS feature is billed based upon the actual total route miles in a customer's specific Structural Protection APS or Route Protection APS design as determined by the Telephone Company. The term "route miles" is defined for this application to be the actual physical distance or length (not airline mileage), rounded up to the next whole mile, of the unique APS facility designed for each individual customer premises. Total route miles are measured between the customer premises and its serving wire center, plus route miles between the serving wire center and any intermittent wire centers in the path designed to reach the BellSouth Metro Ethernet wire center associated with the primary Metro Ethernet Connection (i.e., the wire center where the BellSouth Metro Ethernet switching equipment is located).

The APS rate element provides the alternate data channel transport and APS equipment in the BellSouth Metro Ethernet Service wire center associated with the primary Metro Ethernet Connection. Actual total route mileage for the customer's APS design is determined from a Service Inquiry. The route mileage determined from this Telephone Company Service Inquiry is used for billing purposes and is the sole determinant of such mileage (i.e., not subject to dispute).

- V. BellSouth Metro Ethernet Service Independent Company (ICO) Trunk Connection

Provides interconnection between BellSouth's Ethernet network and the Ethernet network of an Independent Telephone Company. A BellSouth Metro Ethernet Service ICO Trunk Connection provides data channel transport for connections that are 10 airline miles or less in distance from the BellSouth Metro Ethernet Service ICO Trunk Connection wire center to the meet-point with the Independent Company. Meet-point locations greater than 10 airline miles from the BellSouth Metro Ethernet Service ICO Trunk Connection wire center also require BellSouth Metro Ethernet Service ICO Trunk Additional Mileage charges.

- W. BellSouth Metro Ethernet Service Independent Company (ICO) Trunk Additional Mileage Charges

Additional mileage charges associated with a BellSouth Metro Ethernet Service ICO Trunk Connection apply when the total distance from the BellSouth Metro Ethernet Service ICO Trunk Connection wire center to the meet-point with the Independent Company is greater than 10 miles in length. The additional mileage is measured in airline miles from the BellSouth Metro Ethernet Service wire center associated with the BellSouth Metro Ethernet Service ICO Trunk Connection to the Independent Company meet-point. Fractions of miles will be considered as a whole mile.

**Note 1:** Automatic Protection Switching (APS) is not available for a 2 Mbps, 4 Mbps or 8 Mbps Basic, Premium or Virtual Connection.

**Note 2:** Effective on or after August 22, 2021, this Service will no longer be available for purchase by new or existing customers. In addition, requests to move, add, change, or renew existing service arrangements will not be accepted. Following the expiration of a customer's existing term agreement, service will be provided on a month-to-month basis at the applicable Monthly rates until the service is discontinued. The Company currently plans to discontinue this service on or after March 31, 2023.

(N)

(N)

BELLSOUTH  
TELECOMMUNICATIONS  
TENNESSEE

ACCESS SERVICES TARIFF

Third Revised Page 22.5.3.3  
Cancels Second Revised Page 22.5.3.3

ISSUED: July 30, 2021

EFFECTIVE: August 22, 2021

BY: Joelle Phillips, President - Tennessee  
Nashville, Tennessee

## E7. SPECIAL ACCESS (A.K.A. BELLSOUTH SPA) SERVICE

### E7.2 Service Descriptions (Cont'd)

#### E7.2.18 BellSouth Metro Ethernet Service (Cont'd)<sup>1</sup>

(C)

##### X. Migration to AT&T Switched Ethernet Service<sup>SM</sup>

Customers subscribing to BellSouth Metro Ethernet Service may migrate to AT&T Switched Ethernet Service provided by the Company without incurring termination charges, subject to the following conditions:

- The new AT&T Switched Ethernet Service and the existing BellSouth Metro Ethernet Service must be billed to the same customer of record at the same customer locations.
- The customer's existing service must have been in place for at least 12 months.
- The minimum term for the new service must be at least 12 months and must be equal to or greater than the number of months remaining in the customer's existing Transport Payment Plan (TPP) term.
- The speed (capacity/bandwidth) of the new service must be equal to or greater than that of the existing service.
- The customer must issue a disconnect order for the replaced BellSouth Metro Ethernet Service to be effective within 90 days after the AT&T Switched Ethernet Service installation date. The disconnect and new orders must be coordinated through the Company.
- If overlapping service is required, the period will be limited to not more than 90 days and billing will apply to both services during the time both services are available.

Note 1: Effective on or after August 22, 2021, this Service will no longer be available for purchase by new or existing customers. In addition, requests to move, add, change, or renew existing service arrangements will not be accepted. Following the expiration of a customer's existing term agreement, service will be provided on a month-to-month basis at the applicable Monthly rates until the service is discontinued. The Company currently plans to discontinue this service on or after March 31, 2023.

(N)

(N)

BELLSOUTH  
TELECOMMUNICATIONS  
TENNESSEE

ACCESS SERVICES TARIFF

Tenth Revised Page 23  
Cancels Ninth Revised Page 23

ISSUED: June 9, 2021

EFFECTIVE: June 30, 2021

BY: Joelle Phillips, President - Tennessee  
Nashville, Tennessee

## E7. SPECIAL ACCESS (A.K.A. BELLSOUTH SPA) SERVICE

### E7.3 Channel Interface And Network Channel Codes

This section explains the Channel Interface codes and Network Channel codes that the customer must specify when ordering Special Access (a.k.a. BellSouth SPA) service. Included is an example which explains the specific characters of the code, a glossary of Channel Interface codes, impedance levels, Network Channel codes and compatible Channel Interfaces.

Example: If the customer specifies a NT Network Channel Code and a 2DC8-3 Channel Interface at the customer's premises, the following is being requested:

DC = Facility interface for direct current or voltage

8 = Variable impedance level

3 = Metallic<sup>1</sup> facilities (DC continuity) for direct current/low frequency control signals or slow speed data (30 baud)

(C)

#### E7.3.1 Glossary Of Channel Interface Codes And Options

Code - Option	Definition
AB -	Accepts 20 Hz ringing signal at customer's point of termination
AC -	Accepts 20 Hz ringing signal at the customer's end user's point of termination
CS -	Digital hierarchy interface at Digital Crossconnect System (DCS)
- EA	E & M Signaling
- GO	Ground Start Loop Signaling-Open End
- GS	Ground Start Loop Signaling-Closed End
- LO	Loop Start Loop Signaling-Open End
- LS	Loop Start Loop Signaling-Closed End
- NO	Transmission Only - No Signaling
- R	(DS0) Customer Reconfigurable Voice Grade Service <sup>1</sup>
- 10R	DS1 to DS0 Customer Reconfigurable <sup>1</sup>
- 10	DS1 to DS0 <sup>1</sup>
- 11R	DS1 to DS1 Customer Reconfigurable
- 11	DS1 to DS1
- SP	Resistive Type: Split Path Operation for Data Polling Conference Type
- CF	Resistive Type: Split Path Operation for Symmetrical Voice Conference Type
- BC	CO Bridging: Broadcast for Broadcast Conference Type
CT -	Centrex Type Services Tie Trunk Termination

(C)

(C)

Note 1: Effective June 30, 2021, this Service will no longer be available for purchase by new or existing customers. In addition, requests to move, add, change, or renew existing service arrangements will not be accepted. Following the expiration of a customer's existing term agreement, service will be provided on a month-to-month basis at the applicable Monthly rates until the service is discontinued. The Company currently plans to discontinue this service on or after June 30, 2024.

(N)

(N)

BELLSOUTH  
TELECOMMUNICATIONS  
TENNESSEE

ACCESS SERVICES TARIFF

Third Revised Page 23.0.1  
Cancels Second Revised Page 23.0.1

ISSUED: June 9, 2021

EFFECTIVE: June 30, 2021

BY: Joelle Phillips, President - Tennessee  
Nashville, Tennessee

## E7. SPECIAL ACCESS (A.K.A. BELLSOUTH SPA) SERVICE

### E7.3 Channel Interface And Network Channel Codes (Cont'd)

#### E7.3.1 Glossary Of Channel Interface Codes And Options (Cont'd)

Code - Option	Definition	
DA -	Data stream in VF frequency band at customer's end user's point of termination	
DB -	Data stream in VF frequency band at customer's point of termination	
- 10	VF for TG1 and TG2	
- 43	VF for 43 Telegraph <sup>1</sup> Carrier type signals, TG1 and TG2	(C)
DC -	Direct current or voltage	
- 1	Monitoring interface with series RC combination (McCulloh format)	
- 2	Company energized alarm channel	
- 3	Metallic <sup>1</sup> facilities (DC continuity) for direct current/low frequency control signals or slow speed data (30 baud)	(C)
DD -	Dataphone <sup>®</sup> Select-A-Station (and TABS) interface at customer's point of termination	
DE -	Dataphone <sup>®</sup> Select-A-Station (and TABS) interface at the customer's end user's point of termination	
DS -	Digital hierarchy interface	
- 1K	1.544 Mbps (DS1) ANSI Extended Superframe (ESF) format per TA-TSY-000342	
- 1S	1.544 Mbps (DS1) ANSI Extended Superframe (ESF) format and B8ZS Clear Channel Capability per TA-TSY-000342.	

Note 1: Effective June 30, 2021, this Service will no longer be available for purchase by new or existing customers. In addition, requests to move, add, change, or renew existing service arrangements will not be accepted. Following the expiration of a customer's existing term agreement, service will be provided on a month-to-month basis at the applicable Monthly rates until the service is discontinued. The Company currently plans to discontinue this service on or after June 30, 2024.

(N)  
|  
(N)



BELLSOUTH  
TELECOMMUNICATIONS  
TENNESSEE

## ACCESS SERVICES TARIFF

First Revised Page 23.1  
Cancels Original Page 23.1

ISSUED: February 24, 1997

EFFECTIVE: March 26, 1997

BY: Joelle Phillips, President - Tennessee  
Nashville, Tennessee

**E7. SPECIAL ACCESS (A.K.A. BELLSOUTH SPA) SERVICE**

(T)

**E7.3 Channel Interface And Network Channel Codes (Cont'd)****E7.3.1 Glossary Of Channel Interface Codes And Options (Cont'd)**

<b>Code - Option</b>	<b>Definition</b>
- 15	1.544 Mbps (DS1) Superframe (SF) format per TA-TSY-000342
- 15B	1.544 Mbps (DS1) Superframe (SF) format and B8ZS Clear Channel Capability per TA-TSY-000342
- 15E	8-bit PCM encoded in one 64 Kbps of the DS1 signal
- 15F	8-bit PCM encoded in two 64 Kbps of the DS1 signal

BELLSOUTH  
TELECOMMUNICATIONS  
TENNESSEE

ACCESS SERVICES TARIFF

Eighth Revised Page 24  
Cancels Seventh Revised Page 24

ISSUED: June 9, 2021

EFFECTIVE: June 30, 2021

BY: Joelle Phillips, President - Tennessee  
Nashville, Tennessee

## E7. SPECIAL ACCESS (A.K.A. BELLSOUTH SPA) SERVICE

### E7.3 Channel Interface And Network Channel Codes (Cont'd)

#### E7.3.1 Glossary Of Channel Interface Codes And Options (Cont'd)

Code - Option	Definition
DS -	Digital hierarchy interface
- 15G	8-bit PCM encoded in three 64 Kbps of the DS1 signal
- 15H	14/11-bit PCM encoded in six 64 Kbps of the DS1 signal
- 15J	1.544 Mbps format per PUB 41451 (only available to U.S. Govt. agencies)
- 31	3.152 Mbps (DS1C)
- 31L	3.152 Mbps (DS1C) with SF signaling
- 44	44.736 Mbps (DS3)
- 44L	44.736 Mbps (DS3) with SF signaling
- 63	6.312 Mbps (DS2)
- 63L	6.312 Mbps (DS2) with SF signaling
DU -	Digital access interface
- 19(S) <sup>1</sup>	19.2 Kbps <sup>2</sup>
- 24(S) <sup>1</sup>	2.4 Kbps <sup>2</sup>
- 48(S) <sup>1</sup>	4.8 Kbps <sup>2</sup>
- 56(S) <sup>1</sup>	56.0 Kbps <sup>2</sup>
- 64(S)	64.0 Kbps <sup>2</sup>
- 96(S) <sup>1</sup>	9.6 Kbps <sup>2</sup>
- 1KN	DS1 (1.544 Mbps) ANSI Extended Superframe (ESF) Format per TR-NPL-000054 without line power
- 1SN	DS1 (1.544 Mbps) ANSI Extended Superframe (ESF) Format per TR-NPL-000054, with B8ZS Clear Channel Capability and without line power
- A	DS1 (1.544 Mbps) free-framing format per PUB 41451 with line power (only available to U. S. Govt. agencies)
- AN	DS1 (1.544 Mbps) free-framing format per PUB 41451 without line power (only available to U. S. Govt. agencies)
- BN	DS1 (1.544 Mbps) Superframe (SF) Format per TR-NPL-000054 without line power
- DN	DS1 (1.544 Mbps) Superframe (SF) Format per TR-NPL-000054, with B8ZS Clear Channel Capability and without line power.
- SN	1.544 Mbps (DS1) "ANSI" Extended Superframe (ESF) format and B8ZS Clear Channel Capability
DV -	Data and Voice Multiplexing
- BC	Digital Data Over Voice, 9.6 Kbps <sup>2</sup>

**Note 1:** (S) is an additional BellSouth designation for use when the optional Secondary Channel feature is required.

**Note 2:** Effective June 30, 2021, this Service will no longer be available for purchase by new or existing customers. In addition, requests to move, add, change, or renew existing service arrangements will not be accepted. Following the expiration of a customer's existing term agreement, service will be provided on a month-to-month basis at the applicable Monthly rates until the service is discontinued. The Company currently plans to discontinue this service on or after June 30, 2024.

(C)  
|  
(C)

(C)

(N)  
|  
(N)

BELLSOUTH  
TELECOMMUNICATIONS  
TENNESSEE

## ACCESS SERVICES TARIFF

First Revised Page 24.1  
Cancels Original Page 24.1

ISSUED: February 24, 1997  
BY: Joelle Phillips, President - Tennessee  
Nashville, Tennessee

EFFECTIVE: March 26, 1997

**E7. SPECIAL ACCESS (A.K.A. BELLSOUTH SPA) SERVICE**

(T)

**E7.3 Channel Interface And Network Channel Codes (Cont'd)****E7.3.1 Glossary Of Channel Interface Codes And Options (Cont'd)**

<b>Code - Option</b>	<b>Definition</b>
DX -	Duplex signaling interface at customer's point of termination
DY -	Duplex signaling interface at customer's end user's point of termination.
EA - E	Type I E&M Lead Signaling. Customer at POT or customer's end user at POT originates on E Lead.
EA - M	Type I E&M Lead Signaling. Customer at POT or customer's end user at POT originates on M Lead.
EB - E	Type II E&M Lead Signaling. Customer at POT or customer's end user at POT originates on E Lead.
EB - M	Type II E&M Lead Signaling. Customer at POT or customer's end user at POT originates on M Lead.
EC -	Type III E&M signaling at customer POT.

BELLSOUTH  
TELECOMMUNICATIONS  
TENNESSEE

ACCESS SERVICES TARIFF

Third Revised Page 25  
Cancels Second Revised Page 25

ISSUED: February 24, 1997  
BY: Joelle Phillips, President - Tennessee  
Nashville, Tennessee

EFFECTIVE: March 26, 1997

## E7. SPECIAL ACCESS (A.K.A. BELLSOUTH SPA) SERVICE

(T)

### E7.3 Channel Interface And Network Channel Codes (Cont'd)

#### E7.3.1 Glossary Of Channel Interface Codes And Options (Cont'd)

Code - Option	Definition
EX - A	Tandem channel unit signaling for loop start or ground start and customer supplies open end (dial tone, etc.) functions.
- B	Tandem channel unit signaling for loop start or ground start and customer supplies closed end (dial pulsing, etc.) functions.
GO -	Ground start loop signaling - open end function by customer or customer's end user
GS -	Ground start loop signaling - closed end function by customer or customer's end user
- C	Centrex Type Services foreign exchange termination
- M	For terminating in central office located answering service concentrator
IA -	E.I.A. (25 PIN RS-232)
LA -	End user loop start loop signaling - Type A OPS registered port open end
LB -	End user loop start loop signaling - Type B OPS registered port open end
LC -	End user loop start loop signaling - Type C OPS registered port open end
LO -	Loop start loop signaling - open end function by customer or customer's end user
LR -	20 Hz automatic ringdown interface at customer with Company provided PLAR
LS -	Loop start loop signaling - closed end function by customer or customer's end user
- M	For terminating in central office located answering service concentrator
NO -	No signaling interface, transmission only
PG -	Program transmission - no dc signaling
- 3	Nominal frequency from 200 to 3,500 Hz
- 5	Nominal frequency from 100 to 5,000 Hz
- 8	Nominal frequency from 50 to 8,000 Hz
PR -	Protective relaying <sup>1</sup>
RV - O	Reverse battery signaling, one way operation, originate by customer

Note 1: Available only for the transmission of audio tone protective relaying signals used in the protection of electric power systems during fault conditions.

BELLSOUTH  
TELECOMMUNICATIONS  
TENNESSEE

ACCESS SERVICES TARIFF

Sixth Revised Page 26  
Cancels Fifth Revised Page 26

ISSUED: June 9, 2021

EFFECTIVE: June 30, 2021

BY: Joelle Phillips, President - Tennessee  
Nashville, Tennessee

## E7. SPECIAL ACCESS (A.K.A. BELLSOUTH SPA) SERVICE

### E7.3 Channel Interface And Network Channel Codes (Cont'd)

#### E7.3.1 Glossary Of Channel Interface Codes And Options (Cont'd)

Code - Option	Definition
- T	Reverse battery signaling, one way operation, terminate function by customer or customer's end user
SF -	Single frequency signaling with VF band at either customer POT or customer's end user POT
TF -	Telephotograph <sup>1</sup> interface
TF -	Telephotograph <sup>1</sup> interface
TT -	Telegraph <sup>1</sup> /teletypewriter interface at either customer POT or customer's end user POT
- 2	20.0 milliamperes
TT - 3	3.0 milliamperes
- 6	62.5 milliamperes
	<b>(DELETED)</b>
	<b>(DELETED)</b>

(C)

(C)

Note 1: Effective June 30, 2021, this Service will no longer be available for purchase by new or existing customers. In addition, requests to move, add, change, or renew existing service arrangements will not be accepted. Following the expiration of a customer's existing term agreement, service will be provided on a month-to-month basis at the applicable Monthly rates until the service is discontinued. The Company currently plans to discontinue this service on or after June 30, 2024.

(N)

(N)

BELLSOUTH  
TELECOMMUNICATIONS  
TENNESSEE

ACCESS SERVICES TARIFF

Third Revised Page 27  
Cancels Second Revised Page 27

ISSUED: February 24, 1997  
BY: Joelle Phillips, President - Tennessee  
Nashville, Tennessee

EFFECTIVE: March 26, 1997

## E7. SPECIAL ACCESS (A.K.A. BELLSOUTH SPA) SERVICE

(T)

### E7.3 Channel Interface And Network Channel Codes (Cont'd)

#### E7.3.2 Impedance

The nominal reference impedance with which the channel will be terminated for the purpose of evaluating transmission performance:

Value (ohms)	Code(s)
110	0
150	1
600	2
900	3
135	5
75	6
124	7
Variable	8
100	9

#### E7.3.3 Digital Hierarchy Channel Interface Codes (4DS)

Customers selecting the channelized four-wire DS-1 or higher facility interface option at the customer designated premises will be requested to provide subsequent system and channel assignment data. The various digital bit rates in the digital hierarchy employ the channel interface code 4DS9, 4DS0 or 4DS6 plus the speed options indicated following:

Interface Code and Speed Option	Nominal Bit Rate (Mbps)	Digital Hierarchy Level
4DS9-15	1.544	DS1
4DS9-31	3.152	DS1C
4DS0-63	6.312	DS2
4DS6-44	44.736	DS3

#### E7.3.4 Service Designator/Network Channel Code Conversion Table

The purpose of this table is to show the relationship between the service designator codes (e.g. VG1, MT2, etc.) and the network channel codes that are used for various administrative purposes.

Service Designator Code	Network Channel Code
MT1	NT
MT2	NU

BELLSOUTH  
TELECOMMUNICATIONS  
TENNESSEE

## ACCESS SERVICES TARIFF

Fifth Revised Page 28  
Cancels Fourth Revised Page 28

ISSUED: February 24, 1997  
BY: Joelle Phillips, President - Tennessee  
Nashville, Tennessee

EFFECTIVE: March 26, 1997

**E7. SPECIAL ACCESS (A.K.A. BELLSOUTH SPA) SERVICE**

(T)

**E7.3 Channel Interface And Network Channel Codes (Cont'd)****E7.3.4 Service Designator/Network Channel Code Conversion Table (Cont'd)**

Service Designator	Network Channel
Code	Code
MT3	NV
TG1	NW
TG2	NY
VG1	LB
VG2	LC
VG3	LD
VG4	LE
VG5	LF
VG6	LG
VG7	LH
VG8	LJ
VG9	LK
VG10	LN
VG11	LP
VG12	LR
AP1	PE
AP2	PF
AP3	PJ
AP4	PK
TV3	TZ
DA1	XA
DA2	XB
DA3	XG
DA4	XH
DA5	XE
DA6	YN
HC0	HS
HC1	HC
HC1C	HD
HC2	HE
HC3	HF

**E7.3.5 Reserved For Future Use**

BELLSOUTH  
TELECOMMUNICATIONS  
TENNESSEE  
ISSUED: February 23, 2024  
BY: President - Tennessee  
Nashville, Tennessee

ACCESS SERVICES TARIFF

Seventeenth Revised Page 29  
Cancels Sixteenth Revised Page 29

EFFECTIVE: March 17, 2024

## E7. SPECIAL ACCESS (A.K.A. BELLSOUTH SPA) SERVICE

### E7.4 Rate Regulations

This section contains the specific regulations governing the rates and charges that apply for Special Access (a.k.a. BellSouth SPA) service.

#### E7.4.1 Types Of Rates And Charges

A. There are *two* types of rates and charges. These are monthly rates and nonrecurring charges. The rates and charges are described as follows:

##### 1. Monthly Rates

Monthly rates are flat recurring rates that apply each month or fraction thereof that a Special Access (a.k.a. BellSouth SPA) service is provided. For billing purposes, each month is considered to have 30 days.

Digital Data Access<sup>2</sup> (a.k.a. BellSouth SPA DS0 Digital Data)<sup>3</sup> service and Derived Data Channel Service<sup>3</sup> are offered under two contract plans. Contract plan rates are available in payment periods from twenty-four to forty-two months<sup>1</sup> and in payment periods from forty-three to sixty months<sup>1,2</sup> under conditions specified in the Channel Services Payment Plan in E2.4 of this Tariff. (These payment periods are an exception to those listed in E2.4 of this Tariff.)

Termination Liability charges will not apply for customer requests for moves of service under CSPP subject to the provisions set forth in E2.4.9.A.11. preceding. However, a Termination Liability Charge is applicable at the date of termination if the customer terminates or disconnects the service prior to fulfilling the period of the contract plan except as specified in b. following. For a tariff term plan entered into prior to April 3, 2001 the Termination Liability Charge is determined by multiplying the contracted monthly rate times the number of months in the contract plan, less the contracted monthly rate times the number of months the service has been installed. An example is provided in a. following.

a. A customer subscribes to Digital Data Access<sup>2</sup> (a.k.a. BellSouth SPA DS0 Digital Data)<sup>3</sup> service using the twenty-four to forty-two month<sup>1,2</sup> payment plan. The contract plan period is for thirty months<sup>2</sup>. The subscriber terminates the service after twelve months. The total liability charge is thirty months times the monthly rate. The amount is then reduced to reflect the number of months the subscriber has had the service, which in this example is twelve months. Therefore, the Termination Liability Charge is calculated as follows:

Termination Liability Charge = (30 months x monthly rate) - (12 months x monthly rate)

b. A Termination Liability Charge will not be applicable at the date of termination if the customer terminates or disconnects the service prior to fulfilling the period of the contract plan for customer requested changes to a higher order of service covered by the Channel Services Payment Plan as specified in E2.4.9.A.4.b, or customer requested changes to services not covered by the Channel Services Payment Plan that are offered by the Company under a contract payment plan provided that the applicable conditions set forth in E2.4.9.A.4.b are satisfied.

Contract rates are available for 1.544 Mbps High Capacity<sup>2</sup> (a.k.a. BellSouth SPA DS1) service for variable periods, with rates based on lengths of 36 months<sup>4,5</sup>, 60 months<sup>1,2,4,5</sup> or 84 months<sup>1,2,4,5</sup> under conditions specified in the Channel Service Payment Plan in E2.4 of this Tariff. A Termination Liability Charge is applicable at the date of termination. The applicable charge for a tariff term plan entered into prior to April 3, 2001, will be equal to the number of months remaining in the contract times the monthly contract rate. However, Termination Liability charges will not apply for customer requests for moves of service under CSPP subject to the provisions set forth in E2.4.9.A.11. preceding. (C)

Rates applicable to a month-to-month payment option are subject to Company initiated changes.

Note 1: Effective November 9th, 2013, customers may not establish new term plans greater than 36 months and term plans may not be renewed greater than 36 months.

Note 2: Effective March 28, 2019, Customers may not convert, renew or establish CSPPs for Digital Data Access Service. Customers may not convert or renew CSPPs for High Capacity Service.

Note 3: Effective June 30, 2021, this Service will no longer be available for purchase by new or existing customers. In addition, requests to move, add, change, or renew existing service arrangements will not be accepted. Following the expiration of a customer's existing term agreement, service will be provided on a month-to-month basis at the applicable Monthly rates until the service is discontinued. The Company currently plans to discontinue this service on or after June 30, 2024.

Note 4: Effective November 1, 2022, customers may not establish new term plans of greater than 24 months for High Capacity Service Channel Service Payment Plans.

Note 5: Effective March 17, 2024, customers may not establish new term plans of greater than month-to-month for High Capacity Service Channel Service Payment Plans. (N)



BELLSOUTH  
TELECOMMUNICATIONS  
TENNESSEE

ACCESS SERVICES TARIFF

Fourth Revised Page 29.0.1  
Cancels Third Revised Page 29.0.1

ISSUED: December 9, 2022  
BY: Joelle Phillips, President - Tennessee  
Nashville, Tennessee

EFFECTIVE: January 1, 2023

## E7. SPECIAL ACCESS (A.K.A. BELLSOUTH SPA) SERVICE

### E7.4 Rate Regulations (Cont'd)

#### E7.4.1 Types Of Rates And Charges (Cont'd)

A. (Cont'd)

2. **(DELETED)**

3. Nonrecurring Charges

Nonrecurring charges are one-time charges that apply for specific work activity (i.e., installation or change to an existing service). The types of nonrecurring charges that apply for Special Access (a.k.a. BellSouth SPA) service are:

- Installation of service,
- Installation of optional features and functions, and
- Service rearrangements

The following list identifies the individual Special Access (a.k.a. BellSouth SPA) services provided under Section E7. of this Tariff which are eligible for credit of nonrecurring charges under "Service Installation Guarantee" found in E2.4.10 of this Tariff. Customers with these services are not eligible for the Service Installation Guarantee when the requested installation, move or rearrangement service order interval is four days or less as measured from the Application Date of the order.

- Voice Grade (a.k.a. BellSouth SPA DS0 VG)<sup>3</sup>,
- **(DELETED)**
- Digital Data Access (a.k.a. BellSouth SPA DS0 Digital Data) service<sup>1,3</sup>,
- High Capacity (a.k.a. BellSouth SPA High Capacity) service
- SMARTPath service (a.k.a. BellSouth SPA Shared Ring)
- Commercial Quality Video (a.k.a. BellSouth SPA Commercial Quality Video) service
- SMARTRing<sup>4</sup> service (a.k.a. BellSouth Dedicated Ring)

(T)

**Note 1:** The Data Over Voice Channel optional feature is not eligible for such credit.

**Note 2:** **(DELETED)**

(T)

**Note 3:** Effective June 30, 2021, this Service will no longer be available for purchase by new or existing customers. In addition, requests to move, add, change, or renew existing service arrangements will not be accepted. Following the expiration of a customer's existing term agreement, service will be provided on a month-to-month basis at the applicable Monthly rates until the service is discontinued. The Company currently plans to discontinue this service on or after June 30, 2024.

**Note 4:** Effective on or after December 1, 2021, neither new nor existing customers will be permitted to purchase new SMARTRing Service (Service). In addition, (A) Service Payment Plans greater than 12-months in length will no longer be available; and (B) requests to move, add, change, upgrade, or downgrade existing service arrangements will not be accepted, with the following exceptions: (1) existing customers will be permitted to modify their existing Service and will be able to add new circuits to their existing Service, but will not be permitted to add new nodes in any locations; and (2) any such new circuits will be subject to the customer's existing term payment plan or term agreement for the Service to which they are added. Following the expiration of a customer's existing term agreement, Service will be provided on a month-to-month basis at the applicable Month-to-Month rates until the Service is discontinued.

Effective November 30, 2023, unless specified to the contrary in their existing Service agreements, existing customers may not renew Term Payment Plans or term agreements for Service. In addition, no move, add, or change orders of any type will be accepted.

BELLSOUTH  
TELECOMMUNICATIONS  
TENNESSEE

ACCESS SERVICES TARIFF

Fifteenth Revised Page 29.1  
Cancels Fourteenth Revised Page 29.1

ISSUED: November 10, 2021

EFFECTIVE: December 1, 2021

BY: Joelle Phillips, President - Tennessee  
Nashville, Tennessee

## E7. SPECIAL ACCESS (A.K.A. BELLSOUTH SPA) SERVICE

### E7.4 Rate Regulations (Cont'd)

#### E7.4.1 Types Of Rates And Charges (Cont'd)

##### A. (Cont'd)

##### 3. Nonrecurring Charges (Cont'd)

Provided, however, that the following services are not eligible for such credit. (M)

- FlexServ service (a.k.a. BellSouth SPA Customer Reconfiguration) (C)

- BellSouth Metro Ethernet<sup>2</sup> service

##### a. Installation of Service

Nonrecurring charges apply to each service installed. When one service is ordered and installed, it is billed at the First Service Installed rate. When more than one of the same type of service, between the same locations, for the same customer is ordered and installed at the same time, one at each location is billed at the First Service Installed rate and the others are billed at the Additional Service Installed rate. Nonrecurring charges are per each rate element for Commercial Quality Video (a.k.a. BellSouth SPA Commercial Quality Video) service.

##### b. Installation of Optional Features and Functions

Nonrecurring charges apply for the installation of some of the optional features and functions available with Special Access (a.k.a. BellSouth SPA) service. The Initial nonrecurring charge applies if the feature or function is installed coincident with the primary service. The Subsequent nonrecurring charge applies if the feature or function is installed after the installation of the primary service.

First and Additional nonrecurring charges are applicable to activate each individual Central Office Channel Interface of a DS1 or DS0 Basic Channelization System<sup>1</sup>, and are in addition to the nonrecurring charges for the DS1 or DS0 Basic Channelization System<sup>1</sup>. A "First" Central Office Channel Interface nonrecurring charge is applicable to the first Central Office Channel Interface installed coincident with the installation of a DS1 or DS0 Basic Channelization System<sup>1</sup>, per service request. The "Additional" nonrecurring charge applies for each additional Central Office Channel Interface, of the same type, ordered and installed at the same location, for the same customer, at the same time, on the same order request. Future requests for a Central Office Channel Interface on an existing DS1 or DS0 Basic Channelization System<sup>1</sup> will be treated as new requests and will require "First" and "Additional" Central Office Channel Interface nonrecurring charge application in addition to any other applicable charges. (C)

One nonrecurring charge is applicable for each individual DS1 Level Central Office or Customer Channel Interface and is in addition to any other applicable charge(s).

The nonrecurring charges for the installation of optional features and functions are set forth in E7.5 following as nonrecurring charges for optional features and functions associated with the specific services.

**Note 1:** Effective June 30, 2021, this Service will no longer be available for purchase by new or existing customers. In addition, requests to move, add, change, or renew existing service arrangements will not be accepted. Following the expiration of a customer's existing term agreement, service will be provided on a month-to-month basis at the applicable Monthly rates until the service is discontinued. The Company currently plans to discontinue this service on or after June 30, 2024. (C)

**Note 2:** Effective on or after August 22, 2021, this Service will no longer be available for purchase by new or existing customers. In addition, requests to move, add, change, or renew existing service arrangements will not be accepted. Following the expiration of a customer's existing term agreement, service will be provided on a month-to-month basis at the applicable Monthly rates until the service is discontinued. The Company currently plans to discontinue this service on or after March 31, 2023. (C)

BELLSOUTH  
TELECOMMUNICATIONS  
TENNESSEE

ACCESS SERVICES TARIFF

Thirteenth Revised Page 30  
Cancels Twelfth Revised Page 30

ISSUED: November 10, 2021

EFFECTIVE: December 1, 2021

BY: Joelle Phillips, President - Tennessee  
Nashville, Tennessee

## E7. SPECIAL ACCESS (A.K.A. BELLSOUTH SPA) SERVICE

### E7.4 Rate Regulations (Cont'd)

#### E7.4.1 Types Of Rates And Charges (Cont'd)

##### A. (Cont'd)

##### 4. Service Rearrangements

Service rearrangements are changes to existing (installed) services which do not result in either a change in the minimum period requirements as set forth in E5.2.6 of this Tariff or a change in the physical location of the point of the termination at a customer designated premises. Changes which result in the establishment of new minimum period obligations are treated as disconnects and starts. Changes in the physical location of the point of the termination are treated as moves and are described and charged for as set forth in E7.4.5 following. A change which results from a transfer of service is described and charged as set forth in 5. and E7.5.13 following.

The charge to the customer for the service rearrangement is dependent on whether the change is administrative only in nature or involves actual physical change to the service.

Administrative changes, identified as follows, will be made without charge(s) to the customer. Such changes require the continued provision and billing of the Access Service to the same entity (i.e., customer remains responsible for all outstanding indebtedness for the Access Service). Administrative changes are as follows:

- Change of customer name (i.e., the customer of record does not change but rather the customer of record changes its name -- e.g., AT&T-Long Lines to AT&T-Communications),
- Change of customer or customer's end user premises address when the change of address is not a result of a physical relocation of equipment,
- Change in billing data (name, address, or contact name or telephone number, the customer of record does not change),
- Change of customer circuit identification,
- Change of billing account number,
- Change of customer test line number,
- Change of customer or customer's end user contact name or telephone number, and
- Change of jurisdiction, e.g., intraLATA to intrastate, intrastate to interstate, etc. No Termination Liability Charges apply for services billed under the Channel Services Payment Plan (CSPP) if the customer subscribes to a payment arrangement offered in the appropriate tariff which is a minimum twenty-four month<sup>1</sup> service period or equals/exceeds the remaining contract period, whichever is greater.

**Note 1:** Effective March 28, 2019, Customers may not: (1) Establish CSPPs for Derived Data Channel Service, Digital Data Access Service and BellSouth SPA CNM-FlexServ Service, (2) Convert or renew CSPPs for Derived Data Channel Service, Digital Data Access Service, FlexServ Service, High Capacity Service and SMARTPath Service, and 3) Establish CSPPs for SMARTPath Service greater than 36 months.

(M)

(M)

BELLSOUTH  
TELECOMMUNICATIONS  
TENNESSEE

ACCESS SERVICES TARIFF

Seventh Revised Page 31  
Cancels Sixth Revised Page 31

ISSUED: November 10, 2021

EFFECTIVE: December 1, 2021

BY: Joelle Phillips, President - Tennessee  
Nashville, Tennessee

## E7. SPECIAL ACCESS (A.K.A. BELLSOUTH SPA) SERVICE

### E7.4 Rate Regulations (Cont'd)

#### E7.4.1 Types Of Rates And Charges (Cont'd)

##### A. (Cont'd)

##### 4. Service Rearrangements (Cont'd)

All other service rearrangements, including physical changes to existing services, will be charged for as follows: (M)

- If the change involves the addition of other customer designated premises to an existing multipoint service, the nonrecurring charge for the Local Channel rate element(s) being added will apply. Nonrecurring charges for interoffice channel mileage may also apply. (M)

- If the change involves the addition of other customer designated premises to an existing two-point service, resulting in a multipoint circuit configuration, the nonrecurring charge for the local channel rate element(s) being added will apply. Nonrecurring charges for interoffice channel mileage may also apply. (M)

- If the change involves the disconnection of a customer designated premises from an existing multipoint circuit resulting in a two-point circuit configuration, no charges will apply. (M)

- If the change involves the addition of optional features or functions which have separate nonrecurring charges, the nonrecurring charges for the optional features or functions added will apply. (M)

- If the change involves changing (reconfiguring) an existing BellSouth Metro Ethernet<sup>1</sup> service Connection, appropriate charges provided in E7.4.32 following apply. (M) (C)

- If the change involves the addition of a DS3 Network Interface Unit (NIU) to a SMARTRing<sup>2</sup> service (a.k.a. BellSouth SPA Dedicated Ring) the rates and charges shown in E13.3.25 of this Tariff shall apply. (M) (C)

- For all other rearrangements to the service provided or the addition of optional features without separate nonrecurring charges, a charge equal to a Local Channel rate element nonrecurring charge will apply. Only one such charge will apply per service, per change.

##### 5. Transfer of Service

When a change in billing data (e.g., name, address, contact name, or telephone number) is requested in association with a change in the customer of record, transfer of service charges, as set forth in E7.5.13 following will apply. Charges are applied on a Billing Account Number (BAN) and per circuit basis.

#### E7.4.2 Surcharge For Special Access (a.k.a. BellSouth SPA) Service

##### A. General

In addition to the rates and charges described in E7.4.1 preceding, there is a monthly surcharge that applies to Special Access (a.k.a. BellSouth SPA) service. The Special Access (a.k.a. BellSouth SPA) Surcharge compensates the Company for use of the local exchange network when Special Access (a.k.a. BellSouth SPA) service is connected to a PBX or equivalent device which is capable of interconnecting the Special Access (a.k.a. BellSouth SPA) service with local exchange service.

The Company will automatically bill the surcharge on each Special Access (a.k.a. BellSouth SPA) service installed irrespective of whether the interconnection capability exists in the customer's premises equipment or in a Centrex Type Services type switch unless written certification is received from the customer certifying exemption status as set forth in E7.4.2.B. following.

**Note 1:** Effective on or after August 22, 2021, this Service will no longer be available for purchase by new or existing customers. In addition, requests to move, add, change, or renew existing service arrangements will not be accepted. Following the expiration of a customer's existing term agreement, service will be provided on a month-to-month basis at the applicable Monthly rates until the service is discontinued. The Company currently plans to discontinue this service on or after March 31, 2023. (M) (C)

**Note 2:** Effective on or after December 1, 2021, neither new nor existing customers will be permitted to purchase new SMARTRing Service (Service). In addition, (A) Service Payment Plans greater than 12-months in length will no longer be available; and (B) requests to move, add, change, upgrade, or downgrade existing service arrangements will not be accepted, with the following exceptions: (1) existing customers will be permitted to modify their existing Service and will be able to add new circuits to their existing Service, but will not be permitted to add new nodes in any locations; and (2) any such new circuits will be subject to the customer's existing term payment plan or term agreement for the Service to which they are added. Following the expiration of a customer's existing term agreement, Service will be provided on a month-to-month basis at the applicable Month-to-Month rates until the Service is discontinued. (N)

Effective November 30, 2023, unless specified to the contrary in their existing Service agreements, existing customers may not renew Term Payment Plans or term agreements for Service. In addition, no move, add, or change orders of any type will be accepted. (N)

BELLSOUTH  
TELECOMMUNICATIONS  
TENNESSEE

ACCESS SERVICES TARIFF

Second Revised Page 32  
Cancels First Revised Page 32

ISSUED: February 24, 1997  
BY: Joelle Phillips, President - Tennessee  
Nashville, Tennessee

EFFECTIVE: March 26, 1997

## E7. SPECIAL ACCESS (A.K.A. BELLSOUTH SPA) SERVICE (T)

### E7.4 Rate Regulations (Cont'd)

#### E7.4.2 Surcharge For Special Access (*a.k.a. BellSouth SPA*) Service (Cont'd) (T)

##### B. Special Access (*a.k.a. BellSouth SPA*) Surcharge Exemptions (T)

The Special Access (*a.k.a. BellSouth SPA*) service will be exempted from the surcharge if the customer provides the Company written certification that the Special Access (*a.k.a. BellSouth SPA*) service termination is one of the following: (T)

1. An open-end termination in a Company switch on an FX line, including CCSA and CCSA-equivalent ONALS; or
2. an analog Local Channel that is used for radio or television program transmission; or
3. a termination used for TELEX service; or
4. a termination that by the nature of its operating characteristics could not make use of Company common lines, or
5. a termination that interconnects either directly or indirectly to the local exchange network where the usage is subject to Carrier Common Line charges<sup>1</sup> such as, where the Special Access (*a.k.a. BellSouth SPA*) service accesses only FGA and no local exchange lines, or Special Access (*a.k.a. BellSouth SPA*) service between customer points of termination or Special Access (*a.k.a. BellSouth SPA*) service connecting CCSA or CCSA-type equipment (inter-machine trunks); or (T)
6. a termination that the customer certifies to the Company is not connected to a PBX or other device capable of interconnecting the special access facility to a local exchange subscriber line.

##### C. Exemption Certification (T)

1. Special Access (*a.k.a. BellSouth SPA*) services which are terminated as set forth in E7.4.2.B. preceding will be exempted from the Special Access (*a.k.a. BellSouth SPA*) Surcharge if the customer provides the Company with a written notification certifying exemption. Such notification shall be provided by the customer (1) at the time the Special Access (*a.k.a. BellSouth SPA*) service is ordered or installed; (2) at such time as the Special Access (*a.k.a. BellSouth SPA*) service is reterminated to a device not capable of interconnecting to the local exchange network, or (3) at such time as the Special Access (*a.k.a. BellSouth SPA*) service becomes associated with a *BellSouth SWA* that is subject to Carrier Common Line charges. (T)
2. If written certification is not received at the time the Special Access (*a.k.a. BellSouth SPA*) service is obtained, the surcharge will be applied. Exempt status will become effective on the certification date indicated by the customer, subject to the regulations in E7.4.2.D. following. (T)
3. The exemption certification is to be provided by the customer ordering the service. The certification must be signed by the customer or authorized representative and include the category of exemption, as set forth in E7.4.2.B. preceding, for each termination, and the date which the exemption is effective.
4. The customer shall also notify the Company when the exempted Special Access (*a.k.a. BellSouth SPA*) service is changed or reterminated such that the exemption is no longer applicable. (T)

##### D. Crediting the Surcharge (T)

The Company will cease billing the Special Access (*a.k.a. BellSouth SPA*) Surcharge when certification that the Special Access (*a.k.a. BellSouth SPA*) service has become exempt from the surcharge, as set forth in E7.4.2.B. preceding is received. If the status of the Special Access (*a.k.a. BellSouth SPA*) service was changed prior to receipt for the exemption certification, the Company will credit the customer's account, not to exceed ninety (90) days, based on the effective date of the change specified by the customer in the letter of certification. (T)

- Note 1: Resellers of WATS Access Line (*a.k.a. BellSouth SPA WATS Line*) service may be exempted from paying CCL charges during the transition period of June 1, 1986 to January 1, 1987. However, they should not be assessed any Special Access (*a.k.a. BellSouth SPA*) Surcharge on the closed end. (T)

BELLSOUTH  
TELECOMMUNICATIONS  
TENNESSEE

ACCESS SERVICES TARIFF

Thirteenth Revised Page 33  
Cancels Twelfth Revised Page 33

ISSUED: November 10, 2021

EFFECTIVE: December 1, 2021

BY: Joelle Phillips, President - Tennessee  
Nashville, Tennessee

## E7. SPECIAL ACCESS (A.K.A. BELLSOUTH SPA) SERVICE

### E7.4 Rate Regulations (Cont'd)

#### E7.4.2 Surcharge For Special Access (a.k.a. BellSouth SPA) Service (Cont'd)

##### E. Application of Rates

- The monthly Special Access (a.k.a. BellSouth SPA) Surcharge applies to Special Access (a.k.a. BellSouth SPA) services arranged, as set forth in A. preceding, on a per voice equivalent basis as shown in the following example.

	Special Access Service (a.k.a. BellSouth SPA)	Voice Grade Equivalent	Surcharge	Monthly Charge
Voice Grade		1 X	\$ 25.00	\$ 25.00
DS1		24 X	25.00	600.00

- In the case of multipoint Special Access (a.k.a. BellSouth SPA) service, one Special Access (a.k.a. BellSouth SPA) Surcharge will apply for each termination at a customer designated premises except that the surcharge applies at the customer designated premises at which the Access Service is connected to intrastate service.
- The Company will bill the surcharge to the customer who orders the Special Access (a.k.a. BellSouth SPA) service unless the Service is exempt as set forth in B. preceding.  
The rate for the Special Access (a.k.a. BellSouth SPA) Surcharge is set forth in E7.5.10 following.

#### E7.4.3 Message Station Equipment Recovery Charge

The Message Station Equipment Recovery Charge is a charge to recover that portion of message station equipment that is assigned to Special Access (a.k.a. BellSouth SPA) service.

This charge is assessed only to those customers to which the Special Access (a.k.a. BellSouth SPA) Surcharge applies. The rate for the Message Station Equipment Recovery Charge is set forth in E7.5.9.

#### E7.4.4 Minimum Periods

Except under conditions specified in E2.4.9 of this Tariff and following, the minimum service period for all services is one month.

The minimum service period for SMARTPath service (a.k.a. BellSouth SPA Shared Ring), BellSouth Metro Ethernet<sup>1</sup> service and SMARTRing<sup>2</sup> service (a.k.a. BellSouth Dedicated Ring) is four (4) months. (C)

The minimum service period for High Capacity ICB (a.k.a. BellSouth SPA High Capacity) services is specified in the Individual Case Basis Filing.

The minimum service period for Custom Network Service (a.k.a. BellSouth Custom Network Service) is specified in each Custom Network Service Arrangement in E7.7 following.

#### E7.4.5 Moves

##### A. A move involves a change in the physical location of one of the following:

- The point of termination at the customer's premises
- The customer's premises

##### B. The charges for the move are dependent on whether the move is to a new location within the same building or to a different building.

##### 1. Moves Within the Same Building

When the move is to a new location within the same building the charge for the move will be an amount equal to one-half of the nonrecurring (i.e., installation) charge for the service termination affected. There will be no change in the minimum period requirement.

**Note 1:** Effective on or after August 22, 2021, this Service will no longer be available for purchase by new or existing customers. In addition, requests to move, add, change, or renew existing service arrangements will not be accepted. Following the expiration of a customer's existing term agreement, service will be provided on a month-to-month basis at the applicable Monthly rates until the service is discontinued. The Company currently plans to discontinue this service on or after March 31, 2023.

**Note 2:** Effective on or after December 1, 2021, neither new nor existing customers will be permitted to purchase new SMARTRing Service (Service). In addition, (A) Service Payment Plans greater than 12-months in length will no longer be available; and (B) requests to move, add, change, upgrade, or downgrade existing service arrangements will not be accepted, with the following exceptions: (1) existing customers will be permitted to modify their existing Service and will be able to add new circuits to their existing Service, but will not be permitted to add new nodes in any locations; and (2) any such new circuits will be subject to the customer's existing term payment plan or term agreement for the Service to which they are added. Following the expiration of a customer's existing term agreement, Service will be provided on a month-to-month basis at the applicable Month-to-Month rates until the Service is discontinued. (N)

Effective November 30, 2023, unless specified to the contrary in their existing Service agreements, existing customers may not renew Term Payment Plans or term agreements for Service. In addition, no move, add, or change orders of any type will be accepted. (N)

BELLSOUTH  
TELECOMMUNICATIONS  
TENNESSEE

ACCESS SERVICES TARIFF

Sixth Revised Page 34  
Cancels Fifth Revised Page 34

ISSUED: November 10, 2021  
BY: Joelle Phillips, President - Tennessee  
Nashville, Tennessee

EFFECTIVE: December 1, 2021

## E7. SPECIAL ACCESS (A.K.A. BELLSOUTH SPA) SERVICE

### E7.4 Rate Regulations (Cont'd)

#### E7.4.5 Moves (Cont'd)

##### B. (Cont'd)

##### 2. Moves To a Different Building

Moves to a different building, other than addressed in 3. following, will be treated as a discontinuance and start of service and all associated nonrecurring charges will apply. New minimum period requirements will be established for the new services. The customer will also remain responsible for satisfying all outstanding minimum period charges for the discontinued service.

##### 3. Moves of Service(s) under CSPP

Customer requests for moves of service under CSPP, other than inside moves, will be subject to the conditions stated in E2.4.9.A.8. preceding.

#### E7.4.6 Mileage Measurement

- A. The mileage to be used to determine the monthly rate for the Interoffice Channel is calculated on the airline distance between the locations involved i.e., the serving wire centers associated with two customer designated premises, a serving wire center associated with a customer designated premises and a Company hub, a serving wire center associated with a customer designated premises and a WATS serving office, or two Company hubs. The serving wire center associated with a customer designated premises is the serving wire center from which the customer designated premises would normally obtain dial tone.
- B. Mileage is shown in E7.5.2 following in terms of mileage bands. To determine the rate to be billed, first computes the mileage using the V and H coordinates method, as set forth in the National Exchange Carrier Association Tariff F.C.C. No. 4, then find the band into which the computed mileage falls and apply the rates shown for that band. When the calculation results in a fraction of a mile, always round up to the next whole mile before determining the mileage band and applying the rates.
- C. When Hubs are involved, mileage rates are computed and rates applied separately for each section of the Interoffice Channel, i.e., customer designated premises serving wire center to Hub, Hub to Hub and/or Hub to customer designated premises serving wire center. However, when any service is routed through a hub for purposes other than customer specified bridging or channelization (e.g., the Company chooses to so route for test access purposes), rates will be applied only to the distance calculated between the serving wire centers associated with the customer designated premises. For the purpose of applying multipoint charges, the bridging or hubbing locations are determined by that combination of airline distances connecting the serving wire center which will produce the lowest interoffice mileage charges.
- D. SMARTRing<sup>®</sup> service (a.k.a. BellSouth Dedicated Ring) Local Channel, Alternate Central Office Channel and Internodal Channel rates are also distance sensitive. They are measured per quarter airline mile or fraction thereof from the customer's designated premises to the Serving Wire Center, Alternate Central Office, or other Customer Nodes. V&H coordinates are derived for each customer location through the use of longitude and latitude measurements. Using the V&H coordinate method as set forth in the NATIONAL EXCHANGE CARRIER ASSOCIATION, INC. TARIFF FCC. No. 4, compute the mileage, convert to quarter miles, and multiply the appropriate per quarter mile rate by the distance involved. Any portion of a quarter mile will always round up to the next quarter mile before determining the mileage and applying the rate. (C)
- E. The SMARTRing<sup>®</sup> service (a.k.a. BellSouth Dedicated Ring) Interoffice Channel mileage is calculated per quarter airline mile between two directly connected central office's on the ring. Interoffice Channel mileage is computed by using the V&H coordinates method as set forth in the NATIONAL EXCHANGE CARRIER ASSOCIATION, INC. TARIFF FCC. No. 4. To determine the rate to be billed, multiply the appropriate per quarter mile rate by the distance involved. Fractions of a quarter mile always round up to the next quarter mile before determining the mileage and applying the rate. (C)

**Note 1:** Effective on or after December 1, 2021, neither new nor existing customers will be permitted to purchase new SMARTRing Service (Service). In addition, (A) Service Payment Plans greater than 12-months in length will no longer be available; and (B) requests to move, add, change, upgrade, or downgrade existing service arrangements will not be accepted, with the following exceptions: (1) existing customers will be permitted to modify their existing Service and will be able to add new circuits to their existing Service, but will not be permitted to add new nodes in any locations; and (2) any such new circuits will be subject to the customer's existing term payment plan or term agreement for the Service to which they are added. Following the expiration of a customer's existing term agreement, Service will be provided on a month-to-month basis at the applicable Month-to-Month rates until the Service is discontinued. (N)

Effective November 30, 2023, unless specified to the contrary in their existing Service agreements, existing customers may not renew Term Payment Plans or term agreements for Service. In addition, no move, add, or change orders of any type will be accepted. (N)

BELLSOUTH  
TELECOMMUNICATIONS  
TENNESSEE

ACCESS SERVICES TARIFF

Ninth Revised Page 35  
Cancels Eighth Revised Page 35

ISSUED: December 9, 2022

EFFECTIVE: January 1, 2023

BY: Joelle Phillips, President - Tennessee  
Nashville, Tennessee

## E7. SPECIAL ACCESS (A.K.A. BELLSOUTH SPA) SERVICE

### E7.4 Rate Regulations (Cont'd)

#### E7.4.7 Facility Hubs

A customer has the option of ordering Voice Grade (a.k.a. BellSouth SPA DS0 VG)<sup>2</sup> facilities or digital high capacity (a.k.a. BellSouth SPA High Capacity) facilities (i.e., DS1, DS1C, DS2 or DS3) to a facility Hub for channelizing to individual services requiring lower capacity facilities (e.g., Voice (a.k.a. BellSouth SPA DS0 VG)<sup>2</sup>, etc.). (D)

Different locations may be designated as Hubs for different facility capacities, e.g., channelization from digital to digital may occur at one location while channelization from digital to analog may occur at a different location. When ordering, the customer will specify the desired channelization Hub(s) selected from the National Exchange Carrier Association Tariff F.C.C. No. 4. This tariff identifies the type(s) of channelization functions which are available and the serving wire centers at which they are available.

Some of the types of channelization available include the following:

- from higher to lower bit rate
- from digital to voice frequency channels

End to end services may be provided on channels of these facilities to a hub. The transmission performance for the end to end service provided between customer designated premises will be that of the lower capacity or bit rate. For example, when a 1.544 Mbps facility is channelized to voice frequency channels, the transmission performance of the channelized services will be Voice Grade (a.k.a. BellSouth SPA DS0 VG)<sup>2</sup>, not High Capacity (a.k.a. BellSouth SPA High Capacity).

The Company will commence billing the monthly rate for the facility to the Hub on the date specified by the customer on the service order. Individual services utilizing these facilities may be installed coincident with the installation of the facility to the Hub or may be ordered and/or installed at a later date, at the option of the customer. The customer will be billed for a Voice Grade (a.k.a. BellSouth SPA DS0 VG)<sup>2</sup> or digital Local Channel, Interoffice Channel, if applicable and the Basic Channelization System at the time the facility is installed. DS1 and DS0 Basic Channelization Systems<sup>2</sup> require a Central Office Channel Interface for activation of each lesser capacity channel. DS3 to DS1 channelization arrangements, for transport of intrastate DS1 service high capacity channels via LightGate<sup>®</sup> (a.k.a. BellSouth SPA Point to Point Network) and SMARTRing<sup>®3</sup> services (a.k.a. BellSouth SPA Dedicated Ring), require a DS1 channel interface for activation of each DS1 channel. Individual service rates (by service type) will apply for a Local Channel, additional Interoffice Channel and Central Office Channel Interface(s) (as required), if applicable, for each channelized service. These will be billed to the customer as each individual service is installed.

Cascading channelization occurs when a high capacity analog or digital channel is channelized to provide channels with a lesser capacity and one of the lesser capacity channels is further channelized.

When cascading channelization is performed, whether in the same or a different Hub, a charge for the additional Basic Channelization System and Central Office Channel Interface(s) also applies. A DS1 channelization System and DDAS (a.k.a. BellSouth SPA DS0 Digital Data)<sup>2</sup> Central Office Channel Interface are required for high speed or low speed DDAS (a.k.a. BellSouth SPA DS0 Digital Data)<sup>2</sup> activations when channelized from a DS1 (1.544 Mbps) channel. A DS0 Basic Channelization System<sup>2</sup> and Subrate<sup>2</sup> Central Office Channel Interface are required for subrate<sup>2</sup> activations of 2.4, 4.8 and 9.6 Kbps when channelized from a DS0 (64 Kbps)<sup>2</sup> channel. When cascading channelization is performed at different Hubbing locations, Interoffice Channel charges also apply between the Hubs.

A customer can order service(s) between customer designated premises and a hub and will be billed accordingly at the rates set forth in E7.5.5 following for the service, as appropriate. The customer will be charged for each such connection made at the rates for Other Labor as set forth in E13.2.6(c) following. The rates that apply for the service between each customer designated premises and the hub are a Local Channel and Interoffice Channel, if applicable. (D)

**Note 1:** (DELETED)

**Note 2:** Effective June 30, 2021, this Service will no longer be available for purchase by new or existing customers. In addition, requests to move, add, change, or renew existing service arrangements will not be accepted. Following the expiration of a customer's existing term agreement, service will be provided on a month-to-month basis at the applicable Monthly rates until the service is discontinued. The Company currently plans to discontinue this service on or after June 30, 2024. (T)

**Note 3:** Effective on or after December 1, 2021, neither new nor existing customers will be permitted to purchase new SMARTRing Service (Service). In addition, (A) Service Payment Plans greater than 12-months in length will no longer be available; and (B) requests to move, add, change, upgrade, or downgrade existing service arrangements will not be accepted, with the following exceptions: (1) existing customers will be permitted to modify their existing Service and will be able to add new circuits to their existing Service, but will not be permitted to add new nodes in any locations; and (2) any such new circuits will be subject to the customer's existing term payment plan or term agreement for the Service to which they are added. Following the expiration of a customer's existing term agreement, Service will be provided on a month-to-month basis at the applicable Month-to-Month rates until the Service is discontinued.

Effective November 30, 2023, unless specified to the contrary in their existing Service agreements, existing customers may not renew Term Payment Plans or term agreements for Service. In addition, no move, add, or change orders of any type will be accepted.



BELLSOUTH  
TELECOMMUNICATIONS  
TENNESSEE

ACCESS SERVICES TARIFF

Fifteenth Revised Page 36  
Cancels Fourteenth Revised Page 36

ISSUED: November 10, 2021

EFFECTIVE: December 1, 2021

BY: Joelle Phillips, President - Tennessee  
Nashville, Tennessee

## E7. SPECIAL ACCESS (A.K.A. BELLSOUTH SPA) SERVICE

### E7.4 Rate Regulations (Cont'd)

#### E7.4.8 Shared Use Analog And Digital High Capacity (a.k.a. BellSouth SPA High Capacity) Services

Shared use occurs when Special Access (a.k.a. BellSouth SPA) service and BellSouth SWA are provided over the same High Capacity (a.k.a. BellSouth SPA High Capacity) facility through a common interface. When the customer orders Special Access (a.k.a. BellSouth SPA) service, the facility will be ordered and rated as Special Access (a.k.a. BellSouth SPA) service (i.e., Local Channel or Virtual Collocation Cross-Connect, Interoffice Channel as appropriate, and Basic Channelization System, if applicable) until such time as the customer chooses to use a portion of the available capacity for providing BellSouth SWA. As each individual channel is activated for BellSouth SWA, the Special Access (a.k.a. BellSouth SPA) Local Channel rates, and Interoffice Channel rates will be reduced accordingly (e.g., 1/24th for a DS1 service, etc.). The customer must place an order for each individual BellSouth SWA Channel utilizing the Shared Use Facilities and specify the channel assignment for each such service. BellSouth SWA rates and charges as set forth in E6.8 preceding will apply for each channel of the shared use facility that is used to provide BellSouth SWA. Where Special Access (a.k.a. BellSouth SPA) service is provided utilizing a channel of the shared use facility to the hub, High Capacity (a.k.a. BellSouth SPA High Capacity) rates and charges will apply for the facility to the hub as set forth preceding and individual service rates and charges will apply from the hub to the customer designated premises. The rates and charges that will apply to the portion from the hub to the customer designated premises will be dependent on the specific type of Special Access (a.k.a. BellSouth SPA) service that is provided (e.g., Voice Grade (a.k.a. BellSouth SPA DS0 VG)<sup>1</sup>, etc.). The applicable rates and charges will include a Local Channel and Interoffice Channel, and appropriate channelization elements, if applicable.

Access Collocation Cross-Connects provide a means for customers to interconnect their BellSouth Shared Use and Digital High Capacity (a.k.a. BellSouth SPA High Capacity) services to Central Office Collocation arrangements within the same Central Office. Terms, conditions, and rates for Physical Access Collocation Cross-Connects and Virtual Access Collocation Cross-Connects are set forth in Section E13. of this Tariff.

The capability exists for a customer to utilize all or part of a SMARTRing<sup>2</sup> service (a.k.a. BellSouth Dedicated Ring) to transport switched access provided the SMARTRing<sup>2</sup> service (a.k.a. BellSouth Dedicated Ring) channel interface transporting the BellSouth SWA service does not have FlexServ service (a.k.a. BellSouth SPA Customer Reconfiguration) capability. The customer must place an order for each individual BellSouth SWA Channel provided over Dedicated Access service Shared Use Facilities and specify the channel assignment for each such service. The switched traffic would enter and exit the SMARTRing<sup>2</sup> service (a.k.a. BellSouth Dedicated Ring) at Customer and Central Office Nodes on that network. When this occurs, ratcheting of Dedicated Access rate elements (i.e. Nodes, Channel Interfaces, Local Channels, Alternate Central Office Channels, Internodal Channels, or Interoffice Channels) will be based on the number of voice grade (a.k.a. BellSouth SPA DS0 VG)<sup>1</sup> equivalent trunks/lines of that rate element used for BellSouth SWA access.

Reduction factors will be developed to reduce the charges on system level billing as well as the billing on individual DS1, DS3, STS-1, OC-3, and/or OC-12 Channel Interfaces. For ratcheting purposes, the system level charges include Customer Nodes, Central Office Nodes, Local Channels, Alternate Central Office Channels, Internodal Channels, and Interoffice Channels as appropriate to make up a customer's SMARTRing<sup>2</sup> service (a.k.a. BellSouth Dedicated Ring). Individual OC-1, OC-3 and OC-12 Channel Interfaces used in Overlay Ring Arrangements will be ratcheted as system level charges. The system reduction factor will apply to the system level charges.

**Note 1:** Effective June 30, 2021, this Service will no longer be available for purchase by new or existing customers. In addition, requests to move, add, change, or renew existing service arrangements will not be accepted. Following the expiration of a customer's existing term agreement, service will be provided on a month-to-month basis at the applicable Monthly rates until the service is discontinued. The Company currently plans to discontinue this service on or after June 30, 2024.

**Note 2:** Effective on or after December 1, 2021, neither new nor existing customers will be permitted to purchase new SMARTRing Service (Service). In addition, (A) Service Payment Plans greater than 12-months in length will no longer be available; and (B) requests to move, add, change, upgrade, or downgrade existing service arrangements will not be accepted, with the following exceptions: (1) existing customers will be permitted to modify their existing Service and will be able to add new circuits to their existing Service, but will not be permitted to add new nodes in any locations; and (2) any such new circuits will be subject to the customer's existing term payment plan or term agreement for the Service to which they are added. Following the expiration of a customer's existing term agreement, Service will be provided on a month-to-month basis at the applicable Month-to-Month rates until the Service is discontinued.

Effective November 30, 2023, unless specified to the contrary in their existing Service agreements, existing customers may not renew Term Payment Plans or term agreements for Service. In addition, no move, add, or change orders of any type will be accepted.

BELLSOUTH  
TELECOMMUNICATIONS  
TENNESSEE

ACCESS SERVICES TARIFF

First Revised Page 36.0.0.1  
Cancels Original Page 36.0.0.1

ISSUED: November 10, 2021

EFFECTIVE: December 1, 2021

BY: Joelle Phillips, President - Tennessee  
Nashville, Tennessee

## E7. SPECIAL ACCESS (A.K.A. BELLSOUTH SPA) SERVICE

### E7.4 Rate Regulations (Cont'd)

#### E7.4.8 Shared Use Analog And Digital High Capacity (a.k.a. BellSouth SPA High Capacity) Services (Cont'd)

The system reduction factor will be derived by dividing the number of activated BellSouth SWA access circuits by the voice grade (a.k.a. BellSouth SPA DS0 VG)<sup>1</sup> channel equivalent capacity of the self-healing ring. An OC-1 SMARTRing<sup>2</sup> service (a.k.a. BellSouth Dedicated Ring) has 672 voice grade (a.k.a. BellSouth SPA DS0 VG)<sup>1</sup> equivalent channels. An OC-3 SMARTRing<sup>2</sup> service (a.k.a. BellSouth Dedicated Ring) has 2,016 voice grade (a.k.a. BellSouth SPA DS0 VG)<sup>1</sup> equivalent channels. An OC-3+ or OC-12 SMARTRing<sup>2</sup> service (a.k.a. BellSouth Dedicated Ring) has 8,064 voice grade<sup>1</sup> equivalent channels. An OC-48 SMARTRing<sup>2</sup> service (a.k.a. BellSouth Dedicated Ring) or OC-48+ SMARTRing<sup>2</sup> service (a.k.a. BellSouth Dedicated Ring) with 48 or less activated DS3s has 32,256 voice grade (a.k.a. BellSouth SPA DS0 VG)<sup>1</sup> equivalent channels. However, when an OC-48+ SMARTRing<sup>2</sup> service (a.k.a. BellSouth Dedicated Ring) is used to transport BellSouth SWA service, and more than 48 equivalent DS3s are activated on the service, the factor will be based upon the actual number of activated DS3s times 672 DS0s. A factor for individual DS3 channel interfaces and 28 DS1 channel systems, will be derived by dividing the number of activated BellSouth SWA access circuits associated with the DS3 channel by the voice grade (a.k.a. BellSouth SPA DS0 VG)<sup>1</sup> equivalent capacity of the DS3 channel. A DS3 has 672 voice grade (a.k.a. BellSouth SPA DS0 VG)<sup>1</sup> equivalent channels. For DS1 channel interfaces, a factor is derived by dividing the number of BellSouth SWA access circuits associated with the DS1 channel by the voice grade (a.k.a. BellSouth SPA DS0 VG)<sup>1</sup> equivalent capacity of the DS1 channel, which is 24. Each reduction factor is rounded to four decimal places and then multiplied against the respective monthly charges to determine the reduction amount. (M) (C)

BellSouth SWA rates and charges as set forth in E6.8 preceding will apply for each channel of the shared use facility that is used to provide BellSouth SWA. (M)

#### E7.4.9 Reserved For Future Use

#### E7.4.10 Reserved For Future Use

#### E7.4.11 Reserved For Future Use

#### E7.4.12 FlexServ<sup>®</sup> Service (a.k.a. BellSouth SPA Customer Reconfiguration)

When associated with digital single special access services or bulk special access services (1.544 Mbps or greater) this service is a Flex-Price service and is regulated under terms and conditions as described in E2.1.14 of this Tariff.

##### A. General

FlexServ<sup>®</sup> service (a.k.a. BellSouth SPA Customer Reconfiguration) is an optional feature that enables the customer to monitor and reconfigure his Voice Grade (a.k.a. BellSouth SPA DS0 VG), DDAS (a.k.a. BellSouth SPA DS0 Digital Data), and High Capacity special access (a.k.a. BellSouth SPA High Capacity) services without the direct intervention of Company personnel.

##### 1. Basic FlexServ<sup>®</sup> service (a.k.a. BellSouth SPA Customer Reconfiguration)

Basic FlexServ<sup>®</sup> service (a.k.a. BellSouth SPA Customer Reconfiguration) includes monitoring and reconfiguration of the customer's private line services equipped with FlexServ<sup>®</sup> service (a.k.a. BellSouth SPA Customer Reconfiguration). Monitoring consists of unsolicited signals of major and minor facility alarms. These alarms include carrier group alarms, out of service alarms, bit error rate, bipolar violations, slip errors, errored seconds, out-of-frame alarms and invalid connections. Invalid connections are connections between special access services with incompatible signals or between services without FlexServ<sup>®</sup> service (a.k.a. BellSouth SPA Customer Reconfiguration). Customer requests for such connections will be denied. The Company shall not be responsible for service interruptions, troubles, loss of customer data, or any other losses resulting from attempted invalid connections.

**Note 1:** Effective June 30, 2021, this Service will no longer be available for purchase by new or existing customers. In addition, requests to move, add, change, or renew existing service arrangements will not be accepted. Following the expiration of a customer's existing term agreement, service will be provided on a month-to-month basis at the applicable Monthly rates until the service is discontinued. The Company currently plans to discontinue this service on or after June 30, 2024.

**Note 2:** Effective on or after December 1, 2021, neither new nor existing customers will be permitted to purchase new SMARTRing Service (Service). In addition, (A) Service Payment Plans greater than 12-months in length will no longer be available; and (B) requests to move, add, change, upgrade, or downgrade existing service arrangements will not be accepted, with the following exceptions: (1) existing customers will be permitted to modify their existing Service and will be able to add new circuits to their existing Service, but will not be permitted to add new nodes in any locations; and (2) any such new circuits will be subject to the customer's existing term payment plan or term agreement for the Service to which they are added. Following the expiration of a customer's existing term agreement, Service will be provided on a month-to-month basis at the applicable Month-to-Month rates until the Service is discontinued. (N)

Effective November 30, 2023, unless specified to the contrary in their existing Service agreements, existing customers may not renew Term Payment Plans or term agreements for Service. In addition, no move, add, or change orders of any type will be accepted. (N)

Material appearing on this page previously appeared on page(s) 36 of this section.

<sup>®</sup> Registered Service Mark of BellSouth Corporation

BELLSOUTH  
TELECOMMUNICATIONS  
TENNESSEE

ACCESS SERVICES TARIFF

Fourth Revised Page 36.0.1  
Cancels Third Revised Page 36.0.1

ISSUED: March 15, 2002  
BY: Joelle Phillips, President - Tennessee  
Nashville, Tennessee

EFFECTIVE: April 15, 2002

## E7. SPECIAL ACCESS (A.K.A. BELLSOUTH SPA) SERVICE

### E7.4 Rate Regulations (Cont'd)

#### E7.4.12 FlexServ® Service (a.k.a. BellSouth SPA Customer Reconfiguration) (Cont'd)

##### A. General (Cont'd)

##### 1. Basic FlexServ® service (a.k.a. BellSouth SPA Customer Reconfiguration) (Cont'd)

Reconfiguration provides the customer with the ability to direct the Company to connect or disconnect circuits equipped with FlexServ® service (a.k.a. BellSouth SPA Customer Reconfiguration) options to or from each other of like kind at a central office or central offices where the customer has purchased FlexServ® service (a.k.a. BellSouth SPA Customer Reconfiguration). Such connections and disconnections may be performed immediately or at a future time prescribed by the customer and are performed without direct intervention by Company personnel.

The customer is responsible for providing the terminal equipment required for access to FlexServ® service (a.k.a. BellSouth SPA Customer Reconfiguration).

The customer may transmit reconfiguration directions to or receive monitoring information from the Company over a switched service or a private line service. There are several types of access to the service listed in the General Subscriber Services Tariff from which the customer may choose. The type of access chosen will indicate the type of service the customer must provide to a Company location. Each FlexServ® service (a.k.a. BellSouth SPA Customer Reconfiguration) customer must purchase at least one type of access.

Outside of the Company exchange or region, the customer must provide service from his terminal location to the designated Company location from which he may receive monitoring information or transmit reconfiguration directions.

With the customer's initial order for basic FlexServ® service (a.k.a. BellSouth SPA Customer Reconfiguration), the Company provides the capability for one "User Access" for monitoring and reconfiguration signals. This capability is referred to in this Tariff as access to FlexServ® service (a.k.a. BellSouth SPA Customer Reconfiguration) or "User Access". One customer identification code with password security is included with such access.

With the customer's initial order, the Company provides one customer training class for up to **five (5)** persons. The class length of this initial training is **two** consecutive eight hour days. These training classes are conducted at a designated Company location. Transportation, lodging and food for the attendees will be the responsibility of the customer. ***If the customer desires for the initial training to be conducted on his premises, then the customer is responsible for the transportation, lodging and food for the trainer. In addition, the customer is responsible for having the appropriate equipment on his premises.*** (C)

Reconfiguration and monitoring are not available during the performance of routine maintenance of the Company's facilities and equipment used to provide FlexServ® service (a.k.a. BellSouth SPA Customer Reconfiguration).

The Local and Interoffice Channels which are terminated into FlexServ® service (a.k.a. BellSouth SPA Customer Reconfiguration) are subject to all regulations and charges contained in their respective sections of this Tariff in addition to those contained herein.

Different switching options may be available in the same central office. If customers desire more than one switching option in the same central office and facilities are available, a channel connection is required for each FlexServ® service (a.k.a. BellSouth SPA Customer Reconfiguration) switching option connected.

FlexServ® service (a.k.a. BellSouth SPA Customer Reconfiguration) is furnished only in serving wire centers where facilities are available.

BELLSOUTH  
TELECOMMUNICATIONS  
TENNESSEE

ACCESS SERVICES TARIFF

Fourth Revised Page 36.1  
Cancels Third Revised Page 36.1

ISSUED: January 12, 2005  
BY: Joelle Phillips, President - Tennessee  
Nashville, Tennessee

EFFECTIVE: February 2, 2005

## E7. SPECIAL ACCESS (A.K.A. BELLSOUTH SPA) SERVICE

### E7.4 Rate Regulations (Cont'd)

#### E7.4.12 FlexServ Service (a.k.a. BellSouth SPA Customer Reconfiguration) (Cont'd)

##### A. General (Cont'd)

##### 2. Customer Circuits

There are *three* types of channel connections, which can be connected to FlexServ service (a.k.a. BellSouth SPA Customer Reconfiguration) - DS0 (single channel), DS1 (1.544 Mbps) *and DS3 (44.736 Mbps) digital circuits.* (T)

DS0 Channel Connections - There are two types of DS0 channel connections - Voice Grade (a.k.a. BellSouth SPA DS0 VG) and Digital. Both types of DS0 connections will be switched at a DS0 level.

DS1 Channel Connections - There are two types of connections available for a customer desiring to terminate a DS1 circuit - DS0 switching and DS1 switching. For example, if a customer needs to be able to monitor or reconfigure the 24 DS0 circuits riding on the DS1 channel, then the customer would purchase a DS1 channel connection with DS0 switching. If the customer does not need access to the individual DS0 circuits, then the customer would purchase a DS1 channel connection with DS1 switching. *A monitoring only option (i.e., surveillance) is also provided for DS1 channel connections. This option may also be used for terminating SWA DS1 channels.* (C)

DS3 Channel Connections (Monitoring Only) - There are two types of connections available for terminating a DS3 circuit - DS1 and DS3. This option provides for termination of SWA and SPA DS3 channels for monitoring purposes only (i.e., surveillance). If the customer needs monitoring for 28 DS1 circuits, then the customer would purchase a DS3 channel connection at DS1 level. The customer would purchase a DS3 channel connection at DS3 level if the customer wants to monitor the entire DS3 circuit. (N)

##### 3. FlexServ service (a.k.a. BellSouth SPA Customer Reconfiguration) Options

a. Additional Concurrent User Access: This option provides the customer the ability to establish additional concurrent connections to the Company for the communication of monitoring and reconfiguration signals. One additional customer identification code is provided with each additional User Access. For each Additional Concurrent User Access ordered, the customer must also order an additional Management Terminal Interface from the General Subscriber Services Tariff. (T)

b. Additional User Identification Codes: This option provides customer identification codes in addition to that provided with each User Access. If the customer has a Dial Access to FlexServ service (a.k.a. BellSouth SPA Customer Reconfiguration), then the customer must also order an additional Security Card from the General Subscriber Services Tariff. (T)

c. Additional Customer Training: This option provides one eight hour day of customer training in addition to that included with basic FlexServ service (a.k.a. BellSouth SPA Customer Reconfiguration). These training classes are conducted at a designated Company location. All other terms that apply for the initial training apply for the subsequent training. (T)

d. Multipoint Bridging: Multipoint Bridging is a capability, which permits the cross connection of multiple channels equipped with FlexServ service (a.k.a. BellSouth SPA Customer Reconfiguration). (T)

(1) Multipoint Bridging, sometimes referred to as "DMB", is an option on voice grade (a.k.a. BellSouth SPA DS0 VG) service that allows the customer the capability to perform reconfigurations that cross-connect or bridge three or more channels in the FlexServ service (a.k.a. BellSouth SPA Customer Reconfiguration) arrangement into one conferencing arrangement. (T)

(2) Multipoint Junction Unit option gives the customer the ability to bridge one master and four patron legs for use with Digital Data Access (a.k.a. BellSouth SPA DS0 Digital Data) service. If more than one MJU is required, one of the four patron legs must be used to connect to the master leg of another MJU. The customer is responsible for this connection. The MJU feature is only offered in a unit of five channel connections (one master and 4 legs).

BELLSOUTH  
TELECOMMUNICATIONS  
TENNESSEE

ACCESS SERVICES TARIFF

Sixth Revised Page 36.2  
Cancels Fifth Revised Page 36.2

ISSUED: April 13, 2005  
BY: Joelle Phillips, President - Tennessee  
Nashville, Tennessee

EFFECTIVE: May 4, 2005

## E7. SPECIAL ACCESS (A.K.A. BELLSOUTH SPA) SERVICE

### E7.4 Rate Regulations (Cont'd)

#### E7.4.12 FlexServ Service (a.k.a. BellSouth SPA Customer Reconfiguration) (Cont'd)

##### A. General (Cont'd)

##### 3. FlexServ service (a.k.a. BellSouth SPA Customer Reconfiguration) Options (Cont'd)

- e. Subrate Reconfiguration Capability is an option that provides the customer the ability to control all ports of a subrate multiplexer within a FlexServ service (a.k.a. BellSouth SPA Customer Reconfiguration) arrangement. This control includes both the DS0B channel and DS0A legs. The speeds for subrates are 2.4, 4.8, and 9.6 Kbps (does not include 19.2 Kbps). The customer has the responsibility to establish a subrate system using previously acquired DS0 ports.
- f. Reconfigurations by Company Personnel: The customer may request that Company personnel intervene to perform reconfigurations that the customer could otherwise perform without the direct intervention of Company personnel.

##### 4. Shared FlexServ Service (a.k.a. BellSouth SPA Customer Reconfiguration) Arrangement

Multiple customers may include circuits with the FlexServ service (a.k.a. BellSouth SPA Customer Reconfiguration) option in the same FlexServ service (a.k.a. BellSouth SPA Customer Reconfiguration) arrangement, provided all customers designate in writing the same party to serve as their agent. (A FlexServ service (a.k.a. BellSouth SPA Customer Reconfiguration) arrangement consists of all special access (a.k.a. BellSouth SPA) services with FlexServ service that can be monitored and reconfigured through the same User Access.)

The agent will be authorized to represent each of those customers in all transactions and communications with the Company regarding the shared FlexServ service (a.k.a. BellSouth SPA Customer Reconfiguration) arrangement or circuits included in that arrangement including reconfigurations, monitoring, ordering of additional special access (a.k.a. BellSouth SPA) services and FlexServ service (a.k.a. BellSouth SPA Customer Reconfiguration) options in the arrangement, and removal of special access (a.k.a. BellSouth SPA) services from the arrangement. The Company will not process any customer orders or requests affecting that arrangement of circuits included in that arrangement except those submitted to the Company by the agent.

The Company will not be liable for any loss to any of the customers in a shared FlexServ service (a.k.a. BellSouth SPA Customer Reconfiguration) arrangement caused directly or indirectly by actions of the agent or another customer in the shared arrangement. Each customer in the shared arrangement and the agent indemnify the Company for the costs of any and all claims arising directly or indirectly out of the actions of agent or another customer in the shared arrangement, including, but not limited to, the cost of defending against such claims.

Any customer in a shared FlexServ service (a.k.a. BellSouth SPA Customer Reconfiguration) arrangement must give the Company 30 days prior written notice of his intent to revoke an agent's authority or to remove his special access (a.k.a. BellSouth SPA) services from a shared arrangement. Such notice shall not be effective unless it provides the Company with specific and sufficient directions regarding treatment of the customer's special access (a.k.a. BellSouth SPA) services upon revocation of the agent's authority or removal from the shared arrangement.

##### 5. Access Collocation Cross-Connects

**Access Collocation Cross-Connects** provides a means for customers to interconnect their FlexServ service (a.k.a. BellSouth SPA Customer Reconfiguration) to **Central Office Collocation** arrangements *within the same Central Office. Terms, conditions, and rates for Physical Access Collocation Cross-Connects and Virtual Access Collocation Cross-Connects are set forth in Section E13. of this Tariff.*

(C)

(C)

##### B. Application of Rates

##### 1. Basic FlexServ service (a.k.a. BellSouth SPA Customer Reconfiguration)

- a. Connection of Special Access (a.k.a. BellSouth SPA) Service to Reconfiguration and Alarm Monitoring Capability.

A DS0/DS1/DS3 nonrecurring Connection Charge and a recurring monthly rate is required for each entrance and exit of a special access channel to reconfiguration and monitoring capability.

Charges for Access to FlexServ service (a.k.a. BellSouth SPA Customer Reconfiguration) are contained in E7.5.16.

BELLSOUTH  
TELECOMMUNICATIONS  
TENNESSEE

ACCESS SERVICES TARIFF

Fifth Revised Page 36.3  
Cancels Fourth Revised Page 36.3

ISSUED: August 1, 2001  
BY: Joelle Phillips, President - Tennessee  
Nashville, Tennessee

EFFECTIVE: August 15, 2001

## E7. SPECIAL ACCESS (A.K.A BELLSOUTH SPA) SERVICE

### E7.4 Rate Regulations (Cont'd)

#### E7.4.12 FlexServ® Service (a.k.a. BellSouth SPA Customer Reconfiguration) (Cont'd)

##### B. Application of Rates (Cont'd)

##### 2. FlexServ® service (a.k.a. BellSouth SPA Customer Reconfiguration) Options

##### a. Additional Concurrent User Access

For each Additional Concurrent User Access a nonrecurring charge and a recurring monthly rate applies.

##### b. Additional User Identification Codes

A nonrecurring charge applies for each additional ID requested.

##### c. Additional Customer Training

Any additional training will incur a nonrecurring charge for each eight (8) hour day of training.

##### d. Multipoint Bridging

##### Multipoint Bridging (DMB)

There will be a nonrecurring charge and a monthly recurring rate for each DS0 bridging leg that is equipped with this capability.

##### Multipoint Junction Unit

A nonrecurring charge and a monthly rate applies for each DS0 or equivalent that is equipped with this capability. This option must be purchased in groups of 5 because a unit has the capacity of 5 DS0 or equivalent channel connections.

##### e. Subrate Reconfiguration

There will be a nonrecurring charge for each DS0 equipped DS0B and a nonrecurring charge and a monthly rate will apply for each set of DS0As. The DS0A rates apply in sets of five for 9.6 Kbps, in sets of ten for 4.8 Kbps, and in sets of twenty for 2.4 Kbps.

##### f. Reconfigurations by the Company Personnel

A nonrecurring charge is applicable on each occasion, when the customer requests Company personnel to perform a reconfiguration or a series of reconfigurations in order to set up point-to-point or multipoint connections, to provide a status report or to establish a conference.

##### 3. Contract Plans

Contract rates for FlexServ® service (a.k.a. BellSouth SPA Customer Reconfiguration) are available in E7.5.16 under conditions specified in the Channel Services Payment Plan in E2.4 of this Tariff.

Termination Liability is applicable at the date of termination. The applicable charge *for a tariff term plan entered into prior to April 3, 2001*, will be ninety percent of the remaining amount due. Termination Liability will not apply for customer requests for moves of service under CSPP subject to the provisions set forth in E2.4.9.A.11. preceding. (C)

For tariffed term plans entered into on or after April 3, 2001, a customer's liability for the termination of service prior to the time the customer's obligations under the tariff term plan would have otherwise been satisfied are set forth in E2.4.9.A.4. For tariffed term plans entered into before April 3, 2001, the customer's obligations for the termination of service prior to the time the customer's obligations under the term plan would have otherwise been satisfied is governed by the terms of the tariff that were in effect as of the date the customer entered the tariffed term plan. (N)

BELLSOUTH  
TELECOMMUNICATIONS  
TENNESSEE

ACCESS SERVICES TARIFF

Eighth Revised Page 36.4  
Cancels Seventh Revised Page 36.4

ISSUED: November 10, 2021

EFFECTIVE: December 1, 2021

BY: Joelle Phillips, President - Tennessee  
Nashville, Tennessee

## E7. SPECIAL ACCESS (A.K.A. BELLSOUTH SPA) SERVICE

### E7.4 Rate Regulations (Cont'd)

#### E7.4.13 Derived Data Channel (a.k.a. BellSouth SPA Derived Data Channel)<sup>1</sup> Service (DDCS)

##### A. Application of Rates

The derived data channel charges provide the central office data/voice multiplexing capability. The customer must also subscribe to a compatible two-wire local exchange line (e.g., business exchange line). This two-wire exchange line and its associated rates and charges are in addition to the derived data channel rates and charges.

The DS0-B interface charge is applicable for each group of a maximum of twenty multiplexed derived data channels. Each of the twenty channels in a DS0-B interface channel group operates at a bit rate of 2.4 Kbps. The interoffice channel is required when the customer's serving wire center and the serving wire center of the customer's terminating premises are not the same.

#### E7.4.14 SMARTRing<sup>®2</sup> Service (a.k.a. BellSouth Dedicated Ring)

##### A. Self-healing Multi-nodal Alternate Route Topology Ring

1. Monthly rates and charges as specified in E7.5.17 following apply for each SMARTRing<sup>®</sup> service (a.k.a. BellSouth Dedicated Ring). Customers must specify network capacity at the time of the initial order. In an Overlay Ring Arrangement where a customer's overlaying SMARTRing service (a.k.a. BellSouth Dedicated Ring) rides the customer's host SMARTRing<sup>®</sup> service (a.k.a. BellSouth Dedicated Ring), the overlay ring will share the transport of the host ring between common node locations. Rate categories at OC-3, OC-3+, OC-12, OC-24, OC-48, OC-48+, OC-192 and OC-192+ capacity levels include Customer Nodes, Central Office Nodes, Local Channels, Alternate Central Office Channels, Interoffice Channels and Internodal Channels. OC-24 SMARTRing<sup>®</sup> service (a.k.a. BellSouth Dedicated Ring) is only available to existing CSPP customers or under month-to-month arrangements. Rate categories for OC-1 SMARTRing<sup>®</sup> service (a.k.a. BellSouth Dedicated Ring) include Customer Nodes and Central Office Nodes. Channel Interfaces are required at each node on the network and must be associated with a SMARTRing<sup>®</sup> service (a.k.a. BellSouth Dedicated Ring). An OC-1 Overlay Ring Arrangement requires an OC-1 Channel Interface at each node involved. An OC-3 Overlay Ring Arrangement requires an OC-3 Channel Interface at each node involved. An OC-3+ or OC-12 Overlay Ring Arrangement requires an OC-12 Channel Interface at each node involved. An OC-48 or 48+ Overlay Ring Arrangement requires an OC-48 Channel Interface at each node involved. In Overlay Ring Arrangements, the customer must order a Channel Interface for each entry to or exit from the host ring. In all other situations, the number of Channel Interfaces ordered will depend on whether the customer desires a working interface, or a working interface and a protection interface. The quantity of channel interfaces ordered may not exceed the capacity ordered. When a 28 DS1 Channel System is utilized to activate DS1 channels, the appropriate number of DS1 Channel Interfaces are required in lieu of an originating or terminating DS3 or STS-1 Channel Interface.

2. Nonrecurring charges for Local, Alternate Central Office, Interoffice and Internodal Channels apply for each channel for month-to-month customers. Nonrecurring charges are not applicable when the ring level rate elements and channel interfaces are ordered under TPP arrangements. SMARTRing<sup>®</sup> service (a.k.a. BellSouth Dedicated Ring) ring level rate elements are defined as following: Local Channel, Interoffice Channel, Internodal Channel, Alternate Central Office Channel, Customer Node and Central Office Node. Nonrecurring charges do apply for the Channel Interface Reallocation rate element and the SMARTRing<sup>®</sup> service (a.k.a. BellSouth Dedicated Ring) rearrangement rate elements (Surveillance and Reconfiguration) for CSPP and TPP customers. When the customer requests two separate routes and the routing is provided as described in E7.2.16.A preceding, charges apply for the Local Channels and any Interoffice Channels on the requested route. Recurring charges for Local, Alternate Central Office, Interoffice and Internodal Channels apply for each quarter air mile increment of the channel. Fractions of a quarter mile will always round up to the next quarter air mile before determining the mileage and applying the rate. For channels which are less than one quarter mile, a minimum charge of one quarter mile applies.

**Note 1:** Effective June 30, 2021, this Service will no longer be available for purchase by new or existing customers. In addition, requests to move, add, change, or renew existing service arrangements will not be accepted. Following the expiration of a customer's existing term agreement, service will be provided on a month-to-month basis at the applicable Monthly rates until the service is discontinued. The Company currently plans to discontinue this service on or after June 30, 2024.

**Note 2:** Effective on or after December 1, 2021, neither new nor existing customers will be permitted to purchase new SMARTRing Service (Service). In addition, (A) Service Payment Plans greater than 12-months in length will no longer be available; and (B) requests to move, add, change, upgrade, or downgrade existing service arrangements will not be accepted, with the following exceptions: (1) existing customers will be permitted to modify their existing Service and will be able to add new circuits to their existing Service, but will not be permitted to add new nodes in any locations; and (2) any such new circuits will be subject to the customer's existing term payment plan or term agreement for the Service to which they are added. Following the expiration of a customer's existing term agreement, Service will be provided on a month-to-month basis at the applicable Month-to-Month rates until the Service is discontinued.

Effective November 30, 2023, unless specified to the contrary in their existing Service agreements, existing customers may not renew Term Payment Plans or term agreements for Service. In addition, no move, add, or change orders of any type will be accepted.

BELLSOUTH  
TELECOMMUNICATIONS  
TENNESSEE

ACCESS SERVICES TARIFF

Sixth Revised Page 36.5  
Cancels Fifth Revised Page 36.5

ISSUED: November 10, 2021

EFFECTIVE: December 1, 2021

BY: Joelle Phillips, President - Tennessee  
Nashville, Tennessee

## E7. SPECIAL ACCESS (A.K.A. BELLSOUTH SPA) SERVICE

### E7.4 Rate Regulations (Cont'd)

#### E7.4.14 SMARTRing<sup>l</sup> Service (a.k.a. BellSouth Dedicated Ring) Cont'd

(C)

##### A. Self-healing Multi-nodal Alternate Route Topology Ring (Cont'd)

3. For Internodal Channels, charges apply as appropriate either for the same wire center area or contiguous serving wire center areas, as specified in E7.5 17.A.4. (M1)
4. Nonrecurring charges for Customer Nodes and Central Office Nodes apply per node for month-to-month customers and are based upon the capacity of the ring configuration. Nonrecurring charges are not applicable when the preceding rate elements are ordered under TPP arrangements. Recurring rates for Customer and Central Office Nodes apply per node and are also based upon the capacity of the ring configuration. (M1)
5. When the customer orders an OC-1 SMARTRing<sup>®</sup> service (a.k.a. BellSouth Dedicated Ring) Overlay Ring Arrangement riding the customer's host OC-12, OC-48, or OC-48+ SMARTRing<sup>®</sup> service (a.k.a. BellSouth Dedicated Ring), recurring charges apply per OC-1 Customer Node and/or OC-1 Central Office Node, in addition to the recurring and nonrecurring charges for associated Channel Interfaces. (M1)
6. When the customer orders an OC-3 SMARTRing service (a.k.a. BellSouth Dedicated Ring) service Overlay Ring Arrangement riding the customer's host OC-12, OC-48, OC-48+, OC-192 or OC-192+ SMARTRing service (a.k.a. BellSouth Dedicated Ring), recurring charges apply per OC-3 Customer Node and/or OC-3 Central Office Node, in addition to the recurring and nonrecurring charges for associated Channel Interfaces. Nonrecurring charges only apply for month-to-month customers.
7. When the customer orders an OC-3+ or OC-12 Overlay Ring Arrangement riding the customer's host OC-48 SMARTRing service (a.k.a. BellSouth Dedicated Ring), recurring charges apply per OC-3+ and/or OC-12 Customer Node and/or per OC-3+ and/or OC-12 Central Office Node, in addition to the charges for associated Channel Interfaces. Nonrecurring charges only apply for month-to-month customers.
8. In all Overlay Ring Arrangements, the number of OC-1, OC-3, OC-12 and/or OC-48 Channel Interfaces required will be based upon the characteristics of the overlaying ring.
9. The rates for Customer Channel Interfaces apply for each origination and for each termination of an activated DS1, DS3, STS-1, OC-3, OC-12, OC-48 and/or 1000 Mbps interface at the Customer Node. For interfaces ordered on a month-to-month basis the nonrecurring charge applies per interface. For interfaces ordered under CSPP, nonrecurring charges are established on a per order basis for the first DS1, DS3, STS-1, OC-3 and/or OC-12 which originates or terminates at a Customer Node and for each additional DS1, DS3, STS-1, OC-3, and/or OC-12 which originates or terminates at the same Customer Node. For interfaces ordered under TPP, there are no nonrecurring charges associated with the installation. The recurring rate applies on a per Customer Node basis for each origination and for each termination of an activated interface at a Customer Node.

(M2)

**Note 1:** Effective on or after December 1, 2021, neither new nor existing customers will be permitted to purchase new SMARTRing Service (Service). In addition, (A) Service Payment Plans greater than 12-months in length will no longer be available; and (B) requests to move, add, change, upgrade, or downgrade existing service arrangements will not be accepted, with the following exceptions: (1) existing customers will be permitted to modify their existing Service and will be able to add new circuits to their existing Service, but will not be permitted to add new nodes in any locations; and (2) any such new circuits will be subject to the customer's existing term payment plan or term agreement for the Service to which they are added. Following the expiration of a customer's existing term agreement, Service will be provided on a month-to-month basis at the applicable Month-to-Month rates until the Service is discontinued.

(N)

Effective November 30, 2023, unless specified to the contrary in their existing Service agreements, existing customers may not renew Term Payment Plans or term agreements for Service. In addition, no move, add, or change orders of any type will be accepted.

(N)

M1 Material appearing on this page previously appeared on page(s) 36.4 of this section.

M2 Material previously appearing on this page now appears on page(s) 36.6 of this section.



BELLSOUTH  
TELECOMMUNICATIONS  
TENNESSEE

ACCESS SERVICES TARIFF

Second Revised Page 36.6  
Cancels First Revised Page 36.6

ISSUED: November 10, 2021

EFFECTIVE: December 1, 2021

BY: Joelle Phillips, President - Tennessee  
Nashville, Tennessee

## E7. SPECIAL ACCESS (A.K.A. BELLSOUTH SPA) SERVICE

### E7.4 Rate Regulations (Cont'd)

#### E7.4.14 SMARTRing<sup>®3</sup> Service (a.k.a. BellSouth Dedicated Ring) (Cont'd)

##### A. Self-healing Multi-nodal Alternate Route Topology Ring (Cont'd)

10. In addition, OC-12 and or OC-48 customers with DS3 and/or STS-1 interfaces at the Customer Node electing to connect with DS1 services at a Central Office Node, must obtain a 28 DS1 Channel System and the appropriate number of DS1 Channel Interfaces in lieu of a DS3 or STS-1 Channel Interface. A maximum of 28 DS1 Channel Interfaces can be activated for each 28 DS1 Channel System utilized. For service ordered under CSPP, nonrecurring charges are established on a per order basis for the first 28 DS1 Channel System and for each additional 28 DS1 Channel System at that same Central Office Node. Nonrecurring charges are also established for the first DS1 Channel Interface which originates/terminates in a 28 DS1 Channel System and each additional DS1 Channel Interface which originates/terminates in that same DS1 Channel System. For DS1 Channel Systems ordered under TPP, nonrecurring charges do not apply. For DS1 Channel Systems ordered on a month-to-month basis, nonrecurring charges apply. The recurring rate applies for each 28 DS1 Channel System and each DS1 Channel Interface activated per Central Office Node. (M1)
11. A nonrecurring charge applies for SMARTRing service (a.k.a. BellSouth Dedicated Ring) Surveillance, one for each Customer Node and each Central Office Node, per SMARTRing service (a.k.a. BellSouth Dedicated Ring) rearranged. A nonrecurring charge applies for Reconfiguration, one per reconfiguration of each STS-1 group at each node where such reconfiguration capability is desired. These rate elements apply when the Customer adds FlexServ service (a.k.a. BellSouth SPA Customer Reconfiguration) to an existing SMARTRing service (a.k.a. BellSouth Dedicated Ring) as set forth in E7.2.16.A preceding. Reconfiguration is not available with 100 Mbps and 1000 Mbps BellSouth Metro Ethernet<sup>2</sup> Backbone interfaces. (M1)
12. For CSPP customers, first and additional nonrecurring charges will be applied when ordering the same rate element between the same locations with the same installation date. First and additional nonrecurring changes are not applicable under TPP arrangements. (M1)
13. SMARTRing service (a.k.a. BellSouth Dedicated Ring) purchased prior to August 23, 1996, is available under several CSPP arrangements: Plan A (24-48 Months<sup>3</sup>), Plan B (49-72 Months<sup>3</sup>) or Plan C (73-96 Months<sup>3</sup>).<sup>1</sup> Renewals of existing SMARTRing service (a.k.a. BellSouth Dedicated Ring) or purchases of new SMARTRing service (a.k.a. BellSouth Dedicated Ring) on or after August 23, 1996, will only be available under TPP arrangements. In order to accommodate more flexible customer situations, SMARTRing service (a.k.a. BellSouth Dedicated Ring) is available under several TPP arrangements: Plan A (12-36 Months<sup>3</sup>), Plan B (37-60 Months<sup>3</sup>) or Plan C (61-96 Months<sup>3</sup>).<sup>1</sup> Month-to-month arrangements (with a minimum of four months) are available for SMARTRing service (a.k.a. BellSouth Dedicated Ring). (M1) (C)

**Note 1:** All term plans for SMARTRing<sup>®</sup> Service which are established, renewed or extended after December 16, 2013, for term lengths which are scheduled to expire at any time after February 1, 2019, will instead expire on February 1, 2019. All such services existing on or after February 1, 2019, will be provided on a month-to-month basis at the applicable, then current month-to-month rates. (M1)

**Note 2:** Effective on or after August 22, 2021, this Service will no longer be available for purchase by new or existing customers. In addition, requests to move, add, change, or renew existing service arrangements will not be accepted. Following the expiration of a customer's existing term agreement, service will be provided on a month-to-month basis at the applicable Monthly rates until the service is discontinued. The Company currently plans to discontinue this service on or after March 31, 2023. (M1)

**Note 3:** Effective on or after December 1, 2021, neither new nor existing customers will be permitted to purchase new SMARTRing Service (Service). In addition, (A) Service Payment Plans greater than 12-months in length will no longer be available; and (B) requests to move, add, change, upgrade, or downgrade existing service arrangements will not be accepted, with the following exceptions: (1) existing customers will be permitted to modify their existing Service and will be able to add new circuits to their existing Service, but will not be permitted to add new nodes in any locations; and (2) any such new circuits will be subject to the customer's existing term payment plan or term agreement for the Service to which they are added. Following the expiration of a customer's existing term agreement, Service will be provided on a month-to-month basis at the applicable Month-to-Month rates until the Service is discontinued. (N)

Effective November 30, 2023, unless specified to the contrary in their existing Service agreements, existing customers may not renew Term Payment Plans or term agreements for Service. In addition, no move, add, or change orders of any type will be accepted. (N)

M1 Material appearing on this page previously appeared on page(s) 36.5 of this section.

M2 Material previously appearing on this page now appears on page(s) 36.6.1 of this section.

BELLSOUTH  
TELECOMMUNICATIONS  
TENNESSEE

ACCESS SERVICES TARIFF

First Revised Page 36.6.1  
Cancels Original Page 36.6.1

ISSUED: November 10, 2021

EFFECTIVE: December 1, 2021

BY: Joelle Phillips, President - Tennessee  
Nashville, Tennessee

## E7. SPECIAL ACCESS (A.K.A. BELLSOUTH SPA) SERVICE

### E7.4 Rate Regulations (Cont'd)

#### E7.4.14 SMARTRing<sup>®</sup> Service (a.k.a. BellSouth Dedicated Ring) (Cont'd)

(C)

##### A. Self-healing Multi-nodal Alternate Route Topology Ring (Cont'd)

14. CSPP and TPP arrangements are provided under the terms and conditions specified in E2.4.9 preceding, except as modified following. For all payment plans, the following regulations apply: (M1)
  - a. SMARTRing<sup>®</sup> service (a.k.a. BellSouth Dedicated Ring), whether initially or subsequently ordered in conjunction with BellSouth Dedicated Ring, must be provided under the same TPP payment plan with the same service period and both services are to be coterminous. (M1)
  - b. All rate elements, for a given SMARTRing<sup>®</sup> service (a.k.a. BellSouth Dedicated Ring), whether initially or subsequently ordered, must be provided under the same payment plan with the same service period and are coterminous upon disconnect of the SMARTRing<sup>®</sup> service (a.k.a. BellSouth Dedicated Ring). However, Channel Interfaces, except those utilized to interface an overlaying ring with its host ring, may be provided under a month-to-month arrangement which is equal to or less than the payment plan for the associated SMARTRing<sup>®</sup> service (a.k.a. BellSouth Dedicated Ring). Customers with Channel Interfaces provided under a CSPP payment period which began prior to August 22, 1994, may convert those Channel Interfaces to a month-to-month or payment plan arrangement which is equal to or less than the payment plan for the associated SMARTRing<sup>®</sup> service (a.k.a. BellSouth Dedicated Ring), at the current rates and charges. (M1)
  - c. In a shared network arrangement, where the host subscriber and the connecting service user subscribes to services under CSPP or TPP arrangements, the payment periods for directly associated channelized rate elements must be equal to or less than the payment periods for the host service, or the service user must order those rate elements under month-to-month payment terms. Where the host subscriber receives services under month-to-month payment terms, a connecting user must also receive directly associated channelized rate elements under month-to-month payment terms. (M1)
15. The rates applicable to a month-to-month payment plan are subject to Company initiated charges. (M1)
16. For CSPP customers, a termination liability charge will be applicable if services are disconnected prior to the end of the chosen service period. The applicable charge is equal to the number of months remaining in the rate stabilized service period times 60 percent of the monthly rates for SMARTRing<sup>®</sup> service (a.k.a. BellSouth Dedicated Ring) which includes all Nodes, Channel Interfaces, Local Channels, Alternate Central Office Channels, Internodal Channels and/or Interoffice Channels provided under the CSPP arrangement. (M1)
 

Termination liability charges for SMARTRing<sup>®</sup> service (a.k.a. BellSouth Dedicated Ring) TPP customers are applicable as specified in E2.4.9.C preceding. (M1)
17. When a service period under an existing CSPP or TPP arrangement is completed and a customer elects to revert to a month-to-month payment option, no minimum period is applicable. (M1)
18. The TPP customer of record will have a 60 day grace period after which month-to-month rates will apply. (M1)

(M2)

- Note 1:** Effective on or after December 1, 2021, neither new nor existing customers will be permitted to purchase new SMARTRing Service (Service). In addition, (A) Service Payment Plans greater than 12-months in length will no longer be available; and (B) requests to move, add, change, upgrade, or downgrade existing service arrangements will not be accepted, with the following exceptions: (1) existing customers will be permitted to modify their existing Service and will be able to add new circuits to their existing Service, but will not be permitted to add new nodes in any locations; and (2) any such new circuits will be subject to the customer's existing term payment plan or term agreement for the Service to which they are added. Following the expiration of a customer's existing term agreement, Service will be provided on a month-to-month basis at the applicable Month-to-Month rates until the Service is discontinued. (N)
- Effective November 30, 2023, unless specified to the contrary in their existing Service agreements, existing customers may not renew Term Payment Plans or term agreements for Service. In addition, no move, add, or change orders of any type will be accepted. (N)

M1 Material appearing on this page previously appeared on page(s) 36.6 of this section.

M2 Material previously appearing on this page now appears on page(s) 36.7 of this section.

All BellSouth marks contained herein are owned by BellSouth Intellectual Property Corporation

BELLSOUTH  
TELECOMMUNICATIONS  
TENNESSEE

ACCESS SERVICES TARIFF

Seventh Revised Page 36.7  
Cancels Sixth Revised Page 36.7

ISSUED: November 10, 2021  
BY: Joelle Phillips, President - Tennessee  
Nashville, Tennessee

EFFECTIVE: December 1, 2021

## E7. SPECIAL ACCESS (A.K.A. BELLSOUTH SPA) SERVICE

### E7.4 Rate Regulations (Cont'd)

#### E7.4.14 SMARTRing<sup>®</sup> service (a.k.a. BellSouth Dedicated Ring) (Cont'd)

(C)

##### A. Self-healing Multi-nodal Alternate Route Topology Ring (Cont'd)

19. Customers may upgrade from a lower capacity SMARTRing<sup>®</sup> service (a.k.a. BellSouth Dedicated Ring) to a higher capacity SMARTRing<sup>®</sup> service (a.k.a. BellSouth Dedicated Ring) without incurring any termination charges if the following conditions are met:
  - a. the order for the upgraded SMARTRing<sup>®</sup> service (a.k.a. BellSouth Dedicated Ring) and the order for the disconnect of the existing SMARTRing<sup>®</sup> service (a.k.a. BellSouth Dedicated Ring) are received by the Company at the same time, (M)
  - b. the new SMARTRing<sup>®</sup> service (a.k.a. BellSouth Dedicated Ring) is provided between the same customer and Central Office locations as the discontinued SMARTRing<sup>®</sup> service (a.k.a. BellSouth Dedicated Ring), (M)
  - c. the number of Channel Interfaces activated under the new capacity SMARTRing<sup>®</sup> service (a.k.a. BellSouth Dedicated Ring) is greater than the number of Channel Interfaces activated under the existing capacity SMARTRing<sup>®</sup> service (a.k.a. BellSouth Dedicated Ring). (M)
  - d. the expiration date of the new SMARTRing<sup>®</sup> service (a.k.a. BellSouth Dedicated Ring) payment plan is subsequent to the payment plan of the ring being discontinued. (M)
20. Customers may also upgrade existing SMARTRing<sup>®</sup> service (a.k.a. BellSouth Dedicated Ring) to a new SMARTRing<sup>®</sup> service (a.k.a. BellSouth Dedicated Ring) of the same capacity without incurring a termination liability charge, if the customer is concurrently ordering a new capability which cannot be provisioned with the existing SMARTRing<sup>®</sup> service (a.k.a. BellSouth Dedicated Ring) and if the conditions set forth in 19. preceding are met. (M)
21. Ring level billing is defined as billing for the following rate elements: Local Channel, Interoffice Channel, Internodal Channel Alternate Central Office Channel, Customer Node and Central Office Node. Billing for Customer Channel Interfaces and Central Office Channel Interfaces recurring and nonrecurring charges will be effective upon activation to the SMARTRing<sup>®</sup> service (a.k.a. BellSouth Dedicated Ring). (M)
22. If the Service Establishment Date extends beyond one year from the customer's order date due to Company reasons, the preceding conversion provisions apply. If the Service Establishment Date extends beyond one year from the customer's order date for other reasons, the preceding conversion provisions do not apply and billing for all recurring and nonrecurring charges will be effective with the Service Establishment Date.

#### E7.4.15 Reserved for Future Use

#### E7.4.16 Reserved for Future Use

**Note 1:** All term plans for SMARTRing<sup>®</sup> Service which are established, renewed or extended after December 16, 2013, for term lengths which are scheduled to expire at any time after February 1, 2019, will instead expire on February 1, 2019. All such services existing on or after February 1, 2019, will be provided on a month-to-month basis at the applicable, then current month-to-month rates.

**Note 2:** Effective on or after December 1, 2021, neither new nor existing customers will be permitted to purchase new SMARTRing Service (Service). In addition, (A) Service Payment Plans greater than 12-months in length will no longer be available; and (B) requests to move, add, change, upgrade, or downgrade existing service arrangements will not be accepted, with the following exceptions: (1) existing customers will be permitted to modify their existing Service and will be able to add new circuits to their existing Service, but will not be permitted to add new nodes in any locations; and (2) any such new circuits will be subject to the customer's existing term payment plan or term agreement for the Service to which they are added. Following the expiration of a customer's existing term agreement, Service will be provided on a month-to-month basis at the applicable Month-to-Month rates until the Service is discontinued. (N)

Effective November 30, 2023, unless specified to the contrary in their existing Service agreements, existing customers may not renew Term Payment Plans or term agreements for Service. In addition, no move, add, or change orders of any type will be accepted. (N)

BELLSOUTH  
TELECOMMUNICATIONS  
TENNESSEE

ACCESS SERVICES TARIFF

Seventh Revised Page 36.8  
Cancels Sixth Revised Page 36.8

ISSUED: November 10, 2021  
BY: Joelle Phillips, President - Tennessee  
Nashville, Tennessee

EFFECTIVE: December 1, 2021

## E7. SPECIAL ACCESS (A.K.A. BELLSOUTH SPA) SERVICE

### E7.4 Rate Regulations (Cont'd)

#### E7.4.17 SMARTPath Service (a.k.a. BellSouth SPA Shared Ring)

##### A. Application of Rates

Monthly rates and charges as specified in E7.5.17 following apply for each SMARTPath service (a.k.a. BellSouth SPA Shared Ring). The transport provided with a SMARTPath service<sup>2</sup> (a.k.a. BellSouth SPA Shared Ring) Area is provided at 1.544 Mbps. Rate categories include a SMARTPath service (a.k.a. BellSouth SPA Shared Ring) Area Connection, and a SMARTPath service (a.k.a. BellSouth SPA Shared Ring) Area Junction.

The SMARTPath service (a.k.a. BellSouth SPA Shared Ring) Area Connection rate element provides for the connection at the designated premises where the customer gains access to SMARTPath service (a.k.a. BellSouth SPA Shared Ring) and transport to a designated junction on the network. The SMARTPath service (a.k.a. BellSouth SPA Shared Ring) Area Junction rate element provides for the connection between the SMARTPath service (a.k.a. BellSouth SPA Shared Ring) network and (1) another customer designated premises, in the same SMARTPath service (a.k.a. BellSouth SPA Shared Ring) Area or (2) a serving wire center in the same SMARTPath service (a.k.a. BellSouth SPA Shared Ring) Area for connection to (a) DS1 Basic Channelization, FlexServ<sup>2</sup> service (a.k.a. BellSouth SPA Customer Reconfiguration), SMARTRing<sup>3</sup> service (a.k.a. BellSouth Dedicated Ring) or DS3 service as provided in Section E7. of this Tariff, or (b) a SMARTPath service (a.k.a. BellSouth SPA Shared Ring) Area Junction of another SMARTPath service (a.k.a. BellSouth SPA Shared Ring) area in the same Metropolitan Area.

Recurring and nonrecurring charges apply for each SMARTPath service (a.k.a. BellSouth SPA Shared Ring) Area Connection and SMARTPath service (a.k.a. BellSouth SPA Shared Ring) Area Junction.

SMARTPath service (a.k.a. BellSouth SPA Shared Ring) is available under several payment plans: Month-to-month (with a 4 month minimum), Plan A (24-48 Months),<sup>1, 2</sup> or Plan B (49-72 Months).<sup>1, 2</sup> Plan A<sup>1, 2</sup> and Plan B<sup>1, 2</sup> are provided under conditions specified in the Channel Services Payment Plan (CSPP) E2.4.9.A. preceding.

The rates applicable to a month-to-month payment plan are subject to Company initiated changes. Rates stabilized under CSPP are exempt from Company initiated increases, however, decreases for any rate element will automatically flow through to the customer.

A Termination Liability Charge will be applicable if services provided under a CSPP arrangement are disconnected prior to the end of the chosen service period.

The Termination Liability Charge for a tariff term plan entered into prior to April 3, 2001, is equal to the applicable rate per rate element for the current contract multiplied by the difference in months between the time the CSPP contract has been in effect and the minimum contract length multiplied times a factor. The factor is 50 percent for contracts that have been in effect twelve months or less, or 20 percent for contracts that have been in effect longer than twelve months.

For tariffed term plans entered into on or after April 3, 2001, a customer's liability for the termination of service prior to the time the customer's obligations under the tariff term plan would have otherwise been satisfied are set forth in E2.4.9.A.4. For tariffed term plans entered into before April 3, 2001, the customer's obligations for the termination of service prior to the time the customer's obligations under the term plan would have otherwise been satisfied is governed by the terms of the tariff that were in effect as of the date the customer entered the tariffed term plan.

A SMARTPath service (a.k.a. BellSouth SPA Shared Ring) performance credit, as specified in E2.4.4.B. of this Tariff will apply.

Virtual Collocation Cross-Connects provide a means for customers to interconnect their BellSouth SMARTPath service by means of central office cross-connect facilities. Cross-connect rates and charges to SMARTPath service are provided in E7.5 following.

**Note 1:** Effective November 9th, 2013, customers may not establish new term plans greater than 36 months for SMARTPath Service and term plans may not be renewed for a term greater than 36 months.

**Note 2:** Effective March 28, 2019, Customers may not: (1) Convert, renew or establish CSPPs for FlexServ Service and (2) Convert or renew CSPPs for SMARTPath Service.

**Note 3:** Effective on or after December 1, 2021, neither new nor existing customers will be permitted to purchase new SMARTRing Service (Service). In addition, (A) Service Payment Plans greater than 12-months in length will no longer be available; and (B) requests to move, add, change, upgrade, or downgrade existing service arrangements will not be accepted, with the following exceptions: (1) existing customers will be permitted to modify their existing Service and will be able to add new circuits to their existing Service, but will not be permitted to add new nodes in any locations; and (2) any such new circuits will be subject to the customer's existing term payment plan or term agreement for the Service to which they are added. Following the expiration of a customer's existing term agreement, Service will be provided on a month-to-month basis at the applicable Month-to-Month rates until the Service is discontinued.

Effective November 30, 2023, unless specified to the contrary in their existing Service agreements, existing customers may not renew Term Payment Plans or term agreements for Service. In addition, no move, add, or change orders of any type will be accepted.

(C)

(N)

(N)

BELLSOUTH  
TELECOMMUNICATIONS  
TENNESSEE

ACCESS SERVICES TARIFF

Original Page 36.9

ISSUED: February 2, 2005

EFFECTIVE: February 23, 2005

BY: Joelle Phillips, President - Tennessee  
Nashville, Tennessee

## **E7. SPECIAL ACCESS (A.K.A. BELLSOUTH SPA) SERVICE**

### **E7.4 Rate Regulations (Cont'd)**

- E7.4.18 Reserved For Future Use (N)**
- E7.4.19 Reserved For Future Use (N)**
- E7.4.20 Reserved For Future Use (N)**
- E7.4.21 Reserved For Future Use (N)**
- E7.4.22 Reserved For Future Use (N)**
- E7.4.23 Reserved For Future Use (N)**
- E7.4.24 Reserved For Future Use (N)**
- E7.4.25 Reserved For Future Use (N)**
- E7.4.26 Reserved For Future Use (N)**
- E7.4.27 Reserved For Future Use (N)**
- E7.4.28 Reserved For Future Use (N)**
- E7.4.29 Reserved For Future Use (N)**
- E7.4.30 Reserved For Future Use (N)**
- E7.4.31 Reserved For Future Use (N)**

BELLSOUTH  
TELECOMMUNICATIONS  
TENNESSEE

ACCESS SERVICES TARIFF

Fourth Revised Page 36.10  
Cancels Third Revised Page 36.10

ISSUED: July 30, 2021

EFFECTIVE: August 22, 2021

BY: Joelle Phillips, President - Tennessee  
Nashville, Tennessee

## E7. SPECIAL ACCESS (A.K.A. BELLSOUTH SPA) SERVICE

### E7.4 Rate Regulations (Cont'd)

#### E7.4.32 BellSouth Metro Ethernet Service<sup>1</sup>

(C)

##### A. General

1. The minimum service period for BellSouth Metro Ethernet service is four (4) months.
2. Suspension of BellSouth Metro Ethernet service is not allowed.
3. BellSouth Metro Ethernet service is available 24 hours per day, 7 days per week, except for preventive maintenance.  
Due to the nature of BellSouth Metro Ethernet service it will be necessary to perform preventive maintenance and software updates. This will mean that BellSouth Metro Ethernet service will be unavailable during the period of time when preventive maintenance is being performed. This could result in the service being unavailable during the period between 1:00 AM and 5:00 AM Eastern Time on Sundays and Thursdays. However, the Company reserves the right to perform maintenance at any time at its discretion that it believes such maintenance is necessary. The Company will make a reasonable effort to provide notice to those customers likely to be affected by such maintenance work.
4. Obligations of customer and Company:
  - (a) The Company is not responsible for the installation, operation or maintenance of any equipment provided by the customer.
  - (b) The customer is responsible for the provision and maintenance of all customer provided equipment and to insure that the operating characteristics of this equipment is comparable with and does not interfere with the service offered by the Company.
  - (c) At the BellSouth Metro Ethernet service Connection point the customer's signals must conform to IEEE Standards 802.3, 802.3u or 802.3z. To meet end-to-end delay requirements contained in these aforementioned standards, the customer may be required to provide additional equipment.
5. In some cases, the Company and another Incumbent Local Exchange Company (ILEC) may agree to jointly provide a customer Metro Ethernet Service. The rates and charges for the BellSouth Metro Ethernet service Connection are applicable for such connectivity; charges for BellSouth Metro Ethernet Additional Mileage are also applicable when the mileage from the BellSouth/ILEC meet-point to the BellSouth Metro Ethernet wire center associated with the service is over ten (10) miles. The Company is only responsible for the ordering, provisioning, maintaining and billing of such service up to the meet-point (i.e., demarcation point with the ILEC). BellSouth Metro Ethernet service SLA credits shall only be applicable for the portion of the service provided within the territory of the Company; such credits are appropriate only for missed commitments determined to be the fault of the Company.

Note 1: Effective on or after August 22, 2021, this Service will no longer be available for purchase by new or existing customers. In addition, requests to move, add, change, or renew existing service arrangements will not be accepted. Following the expiration of a customer's existing term agreement, service will be provided on a month-to-month basis at the applicable Monthly rates until the service is discontinued. The Company currently plans to discontinue this service on or after March 31, 2023.

(N)

(N)

BELLSOUTH  
TELECOMMUNICATIONS  
TENNESSEE

ACCESS SERVICES TARIFF

Fourth Revised Page 36.10.1  
Cancels Third Revised Page 36.10.1

ISSUED: November 10, 2021  
BY: Joelle Phillips, President - Tennessee  
Nashville, Tennessee

EFFECTIVE: December 1, 2021

## E7. SPECIAL ACCESS (A.K.A. BELLSOUTH SPA) SERVICE

### E7.4 Rate Regulations (Cont'd)

#### E7.4.32 BellSouth Metro Ethernet Service<sup>1</sup>

##### A. General (Cont'd)

6. Basic, Premium and Virtual BellSouth Metro Ethernet Service Connections of 10 Mbps or higher may alternatively be provided to a customer premises over the customer's SMARTRing<sup>2</sup> service (a.k.a. BellSouth SPA Dedicated Ring). The customer is required to purchase the appropriate SMARTRing<sup>2</sup> service (a.k.a. BellSouth SPA Dedicated Ring) BellSouth Metro Ethernet Backbone interfaces that are a bandwidth equal to the bandwidth of the BellSouth Metro Ethernet Service backbone transport that is standard for the specific type and speed of BellSouth Metro Ethernet Service Connection serving that customer premises. (A chart is provided herein which sets forth the backbone bandwidth of each type and speed of BellSouth Metro Ethernet Service Connection.) Standard BellSouth Metro Ethernet Service features are available on such alternative arrangements, with the exception that Automatic Protection Switching is not available. For such applications using SMARTRing<sup>2</sup> service (a.k.a. BellSouth SPA Dedicated Ring) as alternate transport, the BellSouth Metro Ethernet Service Connection will provide data channel transport to connect the termination of the SMARTRing<sup>2</sup> service (a.k.a. BellSouth SPA Dedicated Ring) at the central office node, to the BellSouth Metro Ethernet Service wire center associated with the BellSouth Metro Ethernet Service Connection (i.e., the central office of the Metro Ethernet Service switch). When the SMARTRing<sup>2</sup> service (a.k.a. BellSouth SPA Dedicated Ring) central office node is located greater than 10 miles from the BellSouth Metro Ethernet Service wire center, BellSouth Metro Ethernet Service Additional Mileage charges will also be applicable. For BellSouth Metro Ethernet Service Connections utilizing the customer's LightGate service or SMARTRing<sup>2</sup> service as alternate transport, the committed bandwidth for select speeds will be as shown in BellSouth Technical Reference TR-73632.

<b>Metro Ethernet Connection</b>	<b>Metro Ethernet Backbone Bandwidth</b>
Basic 10 Mbps	100 Mbps (1 STS-1)
Basic 100 Mbps	100 Mbps (3 STS-1)
Basic 1000 Mbps	1000 Mbps
Premium 10, 20, 50 Mbps (Fixed)	100 Mbps (1 STS-1)
Premium 10, 20, 50 Mbps (Burst)	100 Mbps (3 STS-1)
Premium 100 Mbps (Fixed)	Fractional 1000 Mbps at 150 Mbps
Premium 250 Mbps (Fixed )	Fractional 1000 Mbps at 300 Mbps
Premium 500 Mbps (Fixed )	Fractional 1000 Mbps at 600 Mbps
Premium 100, 250, 500 Mbps (Burst)	1000 Mbps
Virtual 10, 20, 50 Mbps	100 Mbps (1 STS-1)
Virtual 80 Mbps	100 Mbps (3 STS-1)
Virtual 100 Mbps	Fractional 1000 Mbps at 150 Mbps
Virtual 200, 300 Mbps	Fractional 1000 Mbps at 300 Mbps
Virtual 450 Mbps	Fractional 1000 Mbps at 450 Mbps
Virtual 600 Mbps	Fractional 1000 Mbps at 600 Mbps
Virtual 750, 900 Mbps	1000 Mbps

**Note 1:** Effective on or after August 22, 2021, this Service will no longer be available for purchase by new or existing customers. In addition, requests to move, add, change, or renew existing service arrangements will not be accepted. Following the expiration of a customer's existing term agreement, service will be provided on a month-to-month basis at the applicable Monthly rates until the service is discontinued. The Company currently plans to discontinue this service on or after March 31, 2023.

**Note 2:** Effective on or after December 1, 2021, neither new nor existing customers will be permitted to purchase new SMARTRing Service (Service). In addition, (A) Service Payment Plans greater than 12-months in length will no longer be available; and (B) requests to move, add, change, upgrade, or downgrade existing service arrangements will not be accepted, with the following exceptions: (1) existing customers will be permitted to modify their existing Service and will be able to add new circuits to their existing Service, but will not be permitted to add new nodes in any locations; and (2) any such new circuits will be subject to the customer's existing term payment plan or term agreement for the Service to which they are added. Following the expiration of a customer's existing term agreement, Service will be provided on a month-to-month basis at the applicable Month-to-Month rates until the Service is discontinued.

Effective November 30, 2023, unless specified to the contrary in their existing Service agreements, existing customers may not renew Term Payment Plans or term agreements for Service. In addition, no move, add, or change orders of any type will be accepted.

BELLSOUTH  
TELECOMMUNICATIONS  
TENNESSEE

ACCESS SERVICES TARIFF

Sixth Revised Page 36.11  
Cancels Fifth Revised Page 36.11

ISSUED: July 30, 2021

EFFECTIVE: August 22, 2021

BY: Joelle Phillips, President - Tennessee  
Nashville, Tennessee

## E7. SPECIAL ACCESS (A.K.A. BELLSOUTH SPA) SERVICE

### E7.4 Rate Regulations (Cont'd)

#### E7.4.32 BellSouth Metro Ethernet Service (Cont'd)<sup>1</sup>

##### A. General (Cont'd)

7. In some cases, the Telephone Company and an Independent Telephone Company (ICO) may agree to jointly provide a customer Metro Ethernet Service. The rates and charges for the BellSouth Metro Ethernet Service Connection are applicable for such connectivity; charges for BellSouth Metro Ethernet Additional Mileage are also applicable when the mileage from the BellSouth/ICO meet-point to the BellSouth Metro Ethernet wire center associated with the service is over 10 miles. The Telephone Company is only responsible for the ordering, provisioning, maintaining and billing of such service up to the meet-point (i.e., demarcation point with the ICO). BellSouth Metro Ethernet Service SLA credits shall only be applicable for the portion of the service provided within the territory of the Telephone Company; such credits are appropriate only for missed commitments determined to be the fault of the Telephone Company.

(C)

(M)

(M)

##### B. Rate Categories and Regulations

1. The following rate categories apply for BellSouth Metro Ethernet service. Applicable rates and charges are provided in E7.5.22 following.
  - (a) Basic BellSouth Metro Ethernet service Connection
  - (b) Premium BellSouth Metro Ethernet service Connection
  - (c) **(DELETE)**
  - (d) Virtual BellSouth Metro Ethernet service Connection
  - (e) BellSouth Metro Ethernet service Additional Mileage Charge
  - (f) Priority Plus Feature
  - (g) Q-Forwarding Feature
  - (h) VLAN Aggregation Feature
  - (i) *CNM* - Metro Ethernet Reporting Feature
  - (j) Class of Service (CoS) Profile
  - (k) Automatic Protection Switching Feature
  - (l) Service Reconfiguration Charge
  - (m) System Reconfiguration Charge
2. BellSouth Metro Ethernet service is available under month-to-month rates as provided in E7.5.22.A. following or under the optional Transport Payment Plan (TPP) (as described in E2.4.9.C. of this Tariff) to receive the TPP rates provided in E7.5.22.B. following.
3. BellSouth Metro Ethernet service Connections are provided utilizing various Ethernet equipment configurations referred to herein as "physical service types". The physical service type of each BellSouth Metro Ethernet Connection is provided in the chart in 5. following.
4. A hierarchy of the various BellSouth Metro Ethernet service Connections by capability (i.e., basic, premium and virtual) and speed is provided in the chart in 5. following. This chart provides a higher order of service ranking that is utilized to determine the appropriate nonrecurring charges for service reconfiguration requests. This ranking is also utilized to determine if termination liability is applicable for specific reconfiguration requests if the service is under a TPP term commitment.

(M) Material appearing on this page previously appeared on page 36.10.1.

Note 1: Effective on or after August 22, 2021, this Service will no longer be available for purchase by new or existing customers. In addition, requests to move, add, change, or renew existing service arrangements will not be accepted. Following the expiration of a customer's existing term agreement, service will be provided on a month-to-month basis at the applicable Monthly rates until the service is discontinued. The Company currently plans to discontinue this service on or after March 31, 2023.

(N)

(N)



BELLSOUTH  
TELECOMMUNICATIONS  
TENNESSEE

ACCESS SERVICES TARIFF

Fourth Revised Page 36.11.1  
Cancels Third Revised Page 36.11.1

ISSUED: July 30, 2021

EFFECTIVE: August 22, 2021

BY: Joelle Phillips, President - Tennessee  
Nashville, Tennessee

## E7. SPECIAL ACCESS (A.K.A. BELLSOUTH SPA) SERVICE

### E7.4 Rate Regulations (Cont'd)

#### E7.4.32 BellSouth Metro Ethernet Service (Cont'd)<sup>3</sup>

(C)

##### B. Rate Categories and Regulations (Cont'd)

5. The following informational chart provides the physical service type of each BellSouth Metro Ethernet Connection and provides the other BellSouth Metro Ethernet Connections which are considered to be a higher order of service (BellSouth Metro Ethernet service hierarchy).

Metro Ethernet Connection (Mbps):	Physical Service Type:	Higher Order of Service (Mbps):
- Basic 2	Basic 0	Basic 4,8,10,100,1000; Premium <sup>1</sup> 2, 4, 8,10,20,50,100,250,500; Virtual 2,4,8,10,20,50,80,100,200,300,450,600,750,900
- Basic 4	Basic 0	Basic 8,10,100,1000; Premium <sup>1</sup> 4, 8,10,20,50,100,250,500; Virtual 4,8,10,20,50,80,100,200,300,450,600,750,900
- Basic 8	Basic 0	Basic 10,100,1000; Premium <sup>1</sup> 8,10,20,50,100,250,500; Virtual 8,10,20,50,80,100,200,300,450,600,750,900
- Basic 10	Basic I	Basic 100,1000; Premium <sup>1</sup> 10,20,50,100,250,500,900 <sup>2</sup> ; Virtual 10,20,50,80,100, 200,300,450,600,750,900
- Basic 100	Basic II	Basic 1000; Premium <sup>1</sup> 100,250,500,900 <sup>2</sup> ; Virtual 80, 100,200,300,450,600,750,900
- Basic 1000	Basic III	Premium <sup>1</sup> 500,900 <sup>2</sup> ; Virtual 450,600,750,900
- Premium 2	Premium 0	Basic 100,1000; Premium <sup>1</sup> 4,8,10,20,50,100,250,500; Virtual 2,4,8,10,20,50,80,100,200,300,450,600,750,900
- Premium 4	Premium 0	Basic 100,1000; Premium <sup>1</sup> 8,10,20,50,100,250,500; Virtual 4,8,10,20,50,80,100,200,300,450,600,750,900
- Premium 8	Premium 0	Basic 100,1000; Premium <sup>1</sup> 10,20,50,100,250,500; Virtual 8,10,20,50,80,100,200,300,450,600,750,900
- Premium <sup>1</sup> 10	Premium I	Basic 1000; Premium <sup>1</sup> 20,50,100,250,500,900 <sup>2</sup> ; Virtual 10,20,50,80,100,200,300, 450,600,750,900
- Premium <sup>1</sup> 20	Premium I	Basic 1000; Premium <sup>1</sup> 50,100,250,500,900 <sup>2</sup> ; Virtual 20,50,80,100,200,300,450, 600,750,900
- Premium <sup>1</sup> 50	Premium I	Premium <sup>1</sup> 100,250,500,900 <sup>2</sup> ; Virtual 50,80,100,200, 300,450,600,750,900
- Premium <sup>1</sup> 100	Premium II	Premium <sup>1</sup> 250,500,900 <sup>2</sup> ; Virtual 100,200,300,450,600,750,900
- Premium <sup>1</sup> 250	Premium II	Premium <sup>1</sup> 500,900 <sup>2</sup> ; Virtual 300,450,600,750,900
- Premium <sup>1</sup> 500	Premium II	Premium 900 <sup>2</sup> ; Virtual 450,600,750,900
- Premium 900 <sup>2</sup>	Premium II	Virtual 900
- Virtual 2	Virtual 0	Basic 100,1000; Premium <sup>1</sup> 10,20,50,100,250,500; Virtual 4,8,10,20,50,80,100,200,300,450,600,750,900
- Virtual 4	Virtual 0	Basic 100,1000; Premium <sup>1</sup> 10,20,50,100,250,500; Virtual 8,10,20,50,80,100,200,300,450,600,750,900
- Virtual 8	Virtual 0	Basic 100,1000; Premium <sup>1</sup> 10,20,50,100,250,500; Virtual 10,20,50,80,100,200,300,450,600,750,900
- Virtual 10	Virtual I	Basic 1000; Premium <sup>1</sup> 20,50,100,250,500,900 <sup>2</sup> ; Virtual 20,50,80,100,200,300,450, 600, 750,900
- Virtual 20	Virtual I	Basic 1000; Premium <sup>1</sup> 50,100,250,500,900 <sup>2</sup> ; Virtual 50,80,100,200,300,450,600,750,900
- Virtual 50	Virtual II	Basic 1000; Premium <sup>1</sup> 100,250,500,900 <sup>2</sup> ; Virtual 80, 100,200,300,450,600,750,900
- Virtual 80	Virtual II	Basic 1000; Premium <sup>1</sup> 100,250,500,900 <sup>2</sup> ; Virtual 100, 200,300,450,600,750,900
- Virtual 100	Virtual II	Premium <sup>1</sup> 250,500,900 <sup>2</sup> ; Virtual 200,300,450,600,750,900
- Virtual 200	Virtual II	Premium <sup>1</sup> 500,900 <sup>2</sup> ; Virtual 300,450,600,750,900
- Virtual 300	Virtual II	Premium <sup>1</sup> 500,900 <sup>2</sup> ; Virtual 450,600,750,900
- Virtual 450	Virtual II	Premium 900 <sup>2</sup> ; Virtual 600,750,900
- Virtual 600	Virtual II	Premium 900 <sup>2</sup> ; Virtual 750,900
- Virtual 750	Virtual II	Premium 900 <sup>2</sup> ; Virtual 900
- Virtual 900	Virtual II	None offered at this time

Note in the above chart that the reference to Basic 1000 Mbps refers to Basic 1 Gbps.

**Note 1:** Fixed Mode or Burst Mode.

**Note 2:** Premium 900 Mbps only available as Fixed Mode.

**Note 3:** Effective on or after August 22, 2021, this Service will no longer be available for purchase by new or existing customers. In addition, requests to move, add, change, or renew existing service arrangements will not be accepted. Following the expiration of a customer's existing term agreement, service will be provided on a month-to-month basis at the applicable Monthly rates until the service is discontinued. The Company currently plans to discontinue this service on or after March 31, 2023.

(N)  
|  
(N)

BELLSOUTH  
TELECOMMUNICATIONS  
TENNESSEE

ACCESS SERVICES TARIFF

Second Revised Page 36.11.2  
Cancels First Revised Page 36.11.2

ISSUED: July 30, 2021

EFFECTIVE: August 22, 2021

BY: Joelle Phillips, President - Tennessee  
Nashville, Tennessee

## E7. SPECIAL ACCESS (A.K.A. BELLSOUTH SPA) SERVICE

### E7.4 Rate Regulations (Cont'd)

#### E7.4.32 BellSouth Metro Ethernet Service (Cont'd)<sup>1</sup>

(C)

##### B. Rate Categories and Regulations (Cont'd)

6. A BellSouth Metro Ethernet reconfiguration nonrecurring charge is applicable for a customer request to reconfigure (rearrange) an existing BellSouth Metro Ethernet Connection. The appropriate reconfiguration charge is dependent upon the physical work required to fulfill the request and applies in lieu of other nonrecurring charges.

A Service Reconfiguration Charge is applicable for requests where the work required is a minor change that does not involve changing the physical service type. The Service Reconfiguration Charge is applicable for a request to change an existing connection to a different connection that is the same physical service type *that is a lower order of service*, is applicable for a request to change a Premium connection from fixed mode to burst mode (and vice versa) and is applicable for a request to change a Premium connection to add or delete the Priority Plus feature. The Service Reconfiguration Charge is also applicable for changing an existing Virtual connection CoS Profile.

A System Reconfiguration Charge is applicable for requests where the work required involves changing to a different physical service type or involves major support system changes. The System Reconfiguration Charge is applicable for requests to change an existing connection to a different connection that is a different physical service type *that is a lower order of service*, to change the network channel terminating equipment (NCTE) interface option from optical to electrical (or vice-versa), and to change the premises powering options from AC power to DC power (or vice-versa).

7. **(DELETED)**

Note 1: Effective on or after August 22, 2021, this Service will no longer be available for purchase by new or existing customers. In addition, requests to move, add, change, or renew existing service arrangements will not be accepted. Following the expiration of a customer's existing term agreement, service will be provided on a month-to-month basis at the applicable Monthly rates until the service is discontinued. The Company currently plans to discontinue this service on or after March 31, 2023.

(N)

(N)

BELLSOUTH  
TELECOMMUNICATIONS  
TENNESSEE

ACCESS SERVICES TARIFF

Third Revised Page 36.12  
Cancels Second Revised Page 36.12

ISSUED: July 30, 2021

EFFECTIVE: August 22, 2021

BY: Joelle Phillips, President - Tennessee  
Nashville, Tennessee

## E7. SPECIAL ACCESS (A.K.A. BELLSOUTH SPA) SERVICE

### E7.4 Rate Regulations (Cont'd)

#### E7.4.32 BellSouth Metro Ethernet Service (Cont'd)<sup>2</sup>

(C)

##### B. Rate Categories and Regulations (Cont'd)

8. A Premium BellSouth Metro Ethernet Connection-Fixed Mode and Premium BellSouth Metro Ethernet Connection-Burst Mode of the same speed are considered to be the same order of service and same physical service type. A Service Reconfiguration Charge is applicable for a customer request to reconfigure a Premium BellSouth Metro Ethernet Connection from Fixed Mode to Burst Mode (at the same speed), or vice versa; this nonrecurring charge is in lieu of the nonrecurring charge for the new connection. Such a change is not treated as a disconnect and there will be no change in the minimum period requirements.
9. Except as specified in 8. preceding, a BellSouth Metro Ethernet Connection not shown as a higher order of service in the hierarchy chart in 5. preceding for a given BellSouth Metro Ethernet Connection is considered to be a lower order of service. A reconfiguration charge is applicable for a customer request to change an existing BellSouth Metro Ethernet Connection to a different BellSouth Metro Ethernet Connection that is a lower order of service; the appropriate reconfiguration charge is applicable in lieu of the standard nonrecurring charge for the lower order of service connection. A Service Reconfiguration Charge is applicable when the lower order of service connection is the same physical service type; a System Reconfiguration Charge is applicable when the lower order of service is a different physical service type. New minimum period requirements are established for the lower order of service connection.
10. A System Reconfiguration Charge is applicable for a customer request to change the premises powering option (AC power to DC power) or NCTE signaling interface option (optical to electrical, or vice-versa) on an existing BellSouth Metro Ethernet Connection. Such a change is not treated as a disconnect and there will be no change in the minimum period requirements.
11. A move of a BellSouth Metro Ethernet service will be as follows (in accordance with E7.4.5 preceding and, if applicable, E2.4.9.C.5. of this Tariff).
 

When the move is to a new location within the same building, the charge for the move will be an amount equal to one-half of the Connection nonrecurring charge. There will be no change in the minimum period requirements.

When the move is to a new location in a different building that is within the same serving wire center, the charge for the move will be the nonrecurring charge for the BellSouth Metro Ethernet service Connection. New minimum period requirements will be established.<sup>1</sup>

When the move is to a new location in a different building that is not in the same serving wire center, the request is treated as a discontinuance and start of service and all associated BellSouth Metro Ethernet service nonrecurring charges will apply. New minimum period requirements will be established.<sup>1</sup>

**Note 1:** Such moves of Metro Ethernet Service with Automatic Protection Switching (APS) shall additionally incur the full nonrecurring charge for establishing the APS feature at the new premises (as a new APS design will be required). The APS monthly recurring charge may change as appropriate based upon the actual route mileage associated with the new premises' APS design.

**Note 2:** Effective on or after August 22, 2021, this Service will no longer be available for purchase by new or existing customers. In addition, requests to move, add, change, or renew existing service arrangements will not be accepted. Following the expiration of a customer's existing term agreement, service will be provided on a month-to-month basis at the applicable Monthly rates until the service is discontinued. The Company currently plans to discontinue this service on or after March 31, 2023.

(N)  
|  
(N)

BELLSOUTH  
TELECOMMUNICATIONS  
TENNESSEE

ACCESS SERVICES TARIFF

Fourth Revised Page 36.13  
Cancels Third Revised Page 36.13

ISSUED: July 30, 2021

EFFECTIVE: August 22, 2021

BY: Joelle Phillips, President - Tennessee  
Nashville, Tennessee

## E7. SPECIAL ACCESS (A.K.A. BELLSOUTH SPA) SERVICE

### E7.4 Rate Regulations (Cont'd)

#### E7.4.32 BellSouth Metro Ethernet Service (Cont'd)<sup>2</sup>

(C)

##### C. Service Level Agreement for Premium BellSouth Metro Ethernet service

Customer networks with Premium BellSouth Metro Ethernet service and Metro Ethernet Reporting are provided Service Level Agreements (SLAs) as summarized herein E7.4.32.C. BellSouth Metro Ethernet Service SLAs outlined herein specify the Company's repair and performance commitments for Metro Ethernet Reporting customers with Premium Metro Ethernet Connections. Details of the technical measurements and performance results methodologies for each commitment are provided in BellSouth Technical Reference TR-73632.

In accordance with E7.4.32.C.3.(c) following, credits are available for missed commitments to customers purchasing Premium BellSouth Metro Ethernet service with the Metro Ethernet Reporting feature. Credits only apply for portions of service provided by the Company.

The following service measurements will outline the service levels the Telephone Company will deliver to *CNM* - Metro Ethernet Reporting customers with Premium Metro Ethernet Connections:

##### Repair Commitment:

- BellSouth Metro Ethernet service Time-to-Repair

##### Network Service Level Commitments:

- BellSouth Metro Ethernet service Core Network Availability
- BellSouth Metro Ethernet service Core Network Latency

The Repair Commitment is measured on a per occurrence basis for each BellSouth Metro Ethernet Connection. A Fault Report is produced thru the *CNM* - Metro Ethernet Reporting system that aids identification of potential outage durations upon which credits may be requested.

The Network Service Level Commitments are measured on the monthly performance of the Metro Ethernet core network during a specific calendar month. An SLA Report is produced thru the Metro Ethernet Reporting system that provides details of missed Network Service Level Commitments upon which credits may be requested based upon a specific calendar month's performance results.

The Company's performance measurement data for the Repair Commitment and Network Service Level Commitments will be collected and calculated utilizing the Company's internal processes as set forth in BellSouth Technical Reference TR-73632. The Company's calculation of its performance shall be the sole determinate of the Company's obligation to provide a credit for a missed performance commitment.

##### 1. SLA Definitions

##### BellSouth Metro Ethernet service Time to Repair<sup>1</sup>

- BellSouth Metro Ethernet service Time-To-Repair measures the outage duration on a customer's BellSouth Metro Ethernet Connection. This measure will require the customer to report the problem to the BellSouth repair center.
- The repair interval will start with the time the trouble ticket is created and end when the fault is re-mediated. The Service Level Commitment measurement will be based on each individual trouble ticket for a customer's connection. Time for scheduled maintenance windows (as set forth in E7.4.32.A.3. preceding) does not count towards SLA threshold.

##### BellSouth Metro Ethernet service Network Availability

- BellSouth Metro Ethernet service Network Availability measures the percentage of time during a calendar month that the customer's service is unavailable on the core network. The core network is defined as being from the Ethernet switch serving the customer's A-end to the Ethernet switch serving the customer's B-end. Customer networks that do not span more than one switch in the core network are not eligible for the Network Availability SLA, and one will not be provided.
- This Service Level Commitment will be calculated by measuring and summing the outage for each core network component used by the customer, divided by the total number of components, times the total service time for a particular calendar month. Excluded from the outage time and service time are scheduled maintenance windows (as set forth in E7.4.32.A.3. preceding) and time the network was unavailable due to circumstances outside the Company's control (as set forth in E7.4.32.C.3.(b) following).

**Note 1:** SLA not applicable if missed due to SMARTRing service (a.k.a BellSouth SPA Dedicated Ring) outage where BellSouth Metro Ethernet is using SMARTRing service (a.k.a BellSouth SPA Dedicated Ring) as alternate transport.

**Note 2:** Effective on or after August 22, 2021, this Service will no longer be available for purchase by new or existing customers. In addition, requests to move, add, change, or renew existing service arrangements will not be accepted. Following the expiration of a customer's existing term agreement, service will be provided on a month-to-month basis at the applicable Monthly rates until the service is discontinued. The Company currently plans to discontinue this service on or after March 31, 2023.

(N)

(N)

BELLSOUTH  
TELECOMMUNICATIONS  
TENNESSEE

ACCESS SERVICES TARIFF

Third Revised Page 36.14  
Cancels Second Revised Page 36.14

ISSUED: July 30, 2021

EFFECTIVE: August 22, 2021

BY: Joelle Phillips, President - Tennessee  
Nashville, Tennessee

## E7. SPECIAL ACCESS (A.K.A. BELLSOUTH SPA) SERVICE

### E7.4 Rate Regulations (Cont'd)

#### E7.4.32 BellSouth Metro Ethernet Service (Cont'd)<sup>2</sup>

(C)

##### C. Service Level Agreement for Premium BellSouth Metro Ethernet service<sup>1</sup> (Cont'd)

###### 1. SLA Definitions (Cont'd)

BellSouth Metro Ethernet service Network Latency

- BellSouth Metro Ethernet service Network Latency measures average one-way delay in milliseconds within the core network. The core network is defined as being from the Ethernet switch serving the customer's A-end to the Ethernet switch serving the customer's B-end. Customer networks that do not span more than one switch in the core network are not eligible for the Network Latency SLA, and one will not be provided.
- This Service Level Commitment will be calculated by averaging the measured latency of simulated traffic within the Metro Ethernet Customer Network (i.e., between each pair of connections) during a calendar month.

###### 2. The Company's Service Level Commitments for Premium BellSouth Metro Ethernet service are as follows:

- BellSouth Metro Ethernet service Time-To-Repair – 4 hours or less
- BellSouth Metro Ethernet service Network Availability – 99.9% or higher
- BellSouth Metro Ethernet service Network Latency – 55 milliseconds or less

###### 3. SLA Restrictions

- (a) The Company will implement SLA provisioning restrictions that will define customer network design requirements and limitations to BellSouth's commitment to meet Service Levels for BellSouth Metro Ethernet service. The customer network design requirements are as follows:
  - A customer must subscribe to the Metro Ethernet Premium Service with *CNM* - Metro Ethernet Reporting to receive credits for missed Service Level Commitments.
  - Credits are not provided for partial month service.
  - A customer's account must be current to receive a credit.
- (b) SLA Credits do not apply when any stated objective is not met because the Company does not have control over the circumstances causing the objective to be missed. Situations over which the Company does not have control include, but are not limited to, the following:
  - any act, any omission or negligence on the part of the customer, any other customer or any third party, or of any other entity providing a portion of the service,
  - labor difficulties, governmental orders, civil commotions, acts of civil or military authority, embargoes, epidemics, declared National Emergencies, criminal actions against the Company, war, terrorist acts, riots, insurrections, fires, explosions, nuclear accidents, power blackouts, acts of God (including, but not limited to, earthquakes, floods or unusually severe weather) or other circumstances beyond the Company's control,
  - the customer's premises equipment, and
  - unavailability of the customer's facilities and/or equipment including customer-provided power and environmental conditions for BellSouth-owned and operated equipment located on the customer's premises.
- (c) The Customer must request a credit within one month of the Company missing a BellSouth Metro Ethernet service Level Commitment. A customer request for a Network Service Level SLA credit must be submitted on a standard request form issued by the Company that includes the month the SLA commitment was missed, accurate identification of the affected circuit, and the observed measurement of the specific SLA that was missed. A customer request for a Repair SLA credit must be submitted on a standard request form issued by the Company that includes the month the SLA commitment was missed, accurate identification of the affected circuit, and the trouble ticket number of the repair request. The Company will investigate customer requests for any SLA credits to determine the cause of any performance failures reported by the customer. The Company will investigate the customer's request over a period of up to 45 calendar days. The 45-day period will begin when the customer makes the request for credit with their BellSouth Sales Representative. SLA credits will be provided to the customer if the Company determines that the Company had control over the circumstances causing the failure.

**Note 1:** Details of the technical measurements and performance results methodologies for each Commitment are provided in BellSouth Technical Reference TR-73632.

**Note 2:** Effective on or after August 22, 2021, this Service will no longer be available for purchase by new or existing customers. In addition, requests to move, add, change, or renew existing service arrangements will not be accepted. Following the expiration of a customer's existing term agreement, service will be provided on a month-to-month basis at the applicable Monthly rates until the service is discontinued. The Company currently plans to discontinue this service on or after March 31, 2023.

(N)

(N)

BELLSOUTH  
TELECOMMUNICATIONS  
TENNESSEE

ACCESS SERVICES TARIFF

Third Revised Page 36.15  
Cancels Second Revised Page 36.15

ISSUED: July 30, 2021

EFFECTIVE: August 22, 2021

BY: Joelle Phillips, President - Tennessee  
Nashville, Tennessee

## E7. SPECIAL ACCESS (A.K.A. BELLSOUTH SPA) SERVICE

### E7.4 Rate Regulations (Cont'd)

#### E7.4.32 BellSouth Metro Ethernet Service (Cont'd)<sup>4</sup>

(C)

##### C. Service Level Agreement for Premium BellSouth Metro Ethernet service<sup>1</sup> (Cont'd)

##### 4. SLA Credits for Premium Connections with *CNM* - Metro Ethernet Reporting

The following credits will apply when the Company misses a Service Level Commitment (each credit is described in (a) thru (c) following):

BellSouth Metro Ethernet service Time-To-Repair:

- 0 to 4 hours per incident: No Credit
- Over 4 hours to 24 hours per incident: A credit equal to 3/30 of the monthly recurring charges for all the rate elements<sup>2</sup> associated with the affected Metro Ethernet Connection
- Each additional 24-hour period, per incident: Credit an additional amount equal to 3/30 of the monthly recurring charges for all the rate elements<sup>2</sup> associated with the affected Metro Ethernet Connection

BellSouth Metro Ethernet service Network Availability:

- A credit equal to 3/30 of the monthly recurring charges for all the rate elements<sup>2</sup> associated with the affected Metro Ethernet Connection.

BellSouth Metro Ethernet service Network Latency:

- A credit equal to 3/30 of the monthly recurring charges for all the rate elements<sup>2</sup> associated with the affected Metro Ethernet Connection.

The SLA credit amount will be determined by applying the credits outlined preceding to the rate elements or total billed revenues specified following.

The total credits issued for all SLAs for a specific BellSouth Metro Ethernet service Connection during a single bill period may not exceed the total monthly recurring charges billed for all the rate elements associated with that BellSouth Metro Ethernet service Connection. Credits are not provided for partial month service.

- (a) BellSouth Metro Ethernet service Time-To-Repair Credit – The Service Level Commitment measurement will be based on each individual trouble ticket for a customer's connection. Multiple trouble tickets on the same day for the same customer connection will only be eligible for one time-to-repair credit. The SLA credit will apply to the monthly recurring charges for all the rate elements<sup>2</sup> associated with the affected Metro Ethernet Connection.
- (b) BellSouth Metro Ethernet service Network Availability Credit<sup>3</sup> – The Service Level commitment measurement will be based on a specific calendar month's performance. The credit will apply for each BellSouth Metro Ethernet service connection that does not meet the availability commitment. The SLA credit will apply to the monthly recurring charges for all the rate elements<sup>2</sup> associated with the affected Metro Ethernet Connection.
- (c) BellSouth Metro Ethernet service Latency Credit<sup>3</sup> – The Service Level commitment measurement will be based on a specific calendar month's performance. The credit will apply for each BellSouth Metro Ethernet service connection that does not meet the latency commitment. The SLA credit will apply to the monthly recurring charges for all the rate elements<sup>2</sup> associated with the affected Metro Ethernet Connection.

**Note 1:** Details of the technical measurements and performance results methodologies for each Commitment are provided in BellSouth Technical Reference TR-73632.

**Note 2:** Specifically, rate elements for the Metro Ethernet Connection, Additional Mileage and Features.

**Note 3:** BellSouth Metro Ethernet networks that do not span more than one switch in the core network are not eligible for credits under this SLA.

**Note 4:** Effective on or after August 22, 2021, this Service will no longer be available for purchase by new or existing customers. In addition, requests to move, add, change, or renew existing service arrangements will not be accepted. Following the expiration of a customer's existing term agreement, service will be provided on a month-to-month basis at the applicable Monthly rates until the service is discontinued. The Company currently plans to discontinue this service on or after March 31, 2023.

(N)  
|  
(N)

BELLSOUTH  
TELECOMMUNICATIONS  
TENNESSEE

ACCESS SERVICES TARIFF

Third Revised Page 36.15.1  
Cancels Second Revised Page 36.15.1

ISSUED: July 30, 2021

EFFECTIVE: August 22, 2021

BY: Joelle Phillips, President - Tennessee  
Nashville, Tennessee

## E7. SPECIAL ACCESS (A.K.A. BELLSOUTH SPA) SERVICE

### E7.4 Rate Regulations (Cont'd)

#### E7.4.32 BellSouth Metro Ethernet Service (Cont'd)<sup>4</sup>

(C)

##### D. Service Level Agreement for Virtual BellSouth Metro Ethernet service

Customer networks with Virtual BellSouth Metro Ethernet Service and *CNM* - Metro Ethernet Reporting are provided Service Level Agreements (SLAs) as summarized herein E7.4.32.D. BellSouth Metro Ethernet Service SLAs outlined herein specify the Telephone Company's repair and performance commitments for *CNM* - Metro Ethernet Reporting customers with Virtual Metro Ethernet Connections. SLAs will be applied on a per Class of Service (CoS) basis for Virtual Connections; traffic representing the different CoS (i.e., Best Effort, Business Critical, Real-Time and Interactive) transported across the same Virtual Connection will have different SLAs. Details of the technical measurements and performance results methodologies for each commitment are provided in BellSouth Technical Reference TR-73632.

In accordance with E7.4.32.D.3.(c) following, credits are available for missed commitments to customers purchasing Virtual BellSouth Metro Ethernet Service with the *CNM* - Metro Ethernet Reporting feature. Credits only apply for portions of service provided by the Telephone Company.

The following service measurements will outline the service levels the Telephone Company will deliver to *CNM* - Metro Ethernet Reporting customers with Virtual Metro Ethernet Connections:

##### Repair Commitment:

- BellSouth Metro Ethernet service Time-to-Repair<sup>1</sup>

##### Network Service Level Commitments:

- BellSouth Metro Ethernet service Core Network Availability
- BellSouth Metro Ethernet service Core Network Latency<sup>2</sup>
- BellSouth Metro Ethernet service Core Network Jitter<sup>2,3</sup>
- BellSouth Metro Ethernet service Core Network Packet Delivery<sup>2</sup>

The Repair Commitment is measured on a per occurrence basis for each BellSouth Metro Ethernet Connection for all CoS. A Fault Report is produced thru the *CNM* - Metro Ethernet Reporting system that aids identification of potential outage durations upon which credits may be requested.

The Network Service Level Commitments are measured on the monthly performance of the Metro Ethernet core network during a specific calendar month by CoS. An SLA Report is produced thru the *CNM* - Metro Ethernet Reporting system that provides details of missed Network Service Level Commitments by CoS upon which credits may be requested based upon a specific calendar month's performance results.

The Company's performance measurement data for the Repair Commitment and Network Service Level Commitments will be collected and calculated utilizing the Company's internal processes as set forth in BellSouth Technical Reference TR-73632. The Company's calculation of its performance shall be the sole determinate of the Company's obligation to provide a credit for a missed performance commitment.

**Note 1:** SLA not applicable if missed due to SMARTRing service (a.k.a BellSouth SPA Dedicated Ring) outage where BellSouth Metro Ethernet is using SMARTRing service (a.k.a BellSouth SPA Dedicated Ring) as alternate transport.

**Note 2:** SLA not applicable for Best Effort CoS.

**Note 3:** SLA not applicable for Business Critical CoS.

**Note 4:** Effective on or after August 22, 2021, this Service will no longer be available for purchase by new or existing customers. In addition, requests to move, add, change, or renew existing service arrangements will not be accepted. Following the expiration of a customer's existing term agreement, service will be provided on a month-to-month basis at the applicable Monthly rates until the service is discontinued. The Company currently plans to discontinue this service on or after March 31, 2023.

(N)

(N)

BELLSOUTH  
TELECOMMUNICATIONS  
TENNESSEE

ACCESS SERVICES TARIFF

First Revised Page 36.15.2  
Cancels Original Page 36.15.2

ISSUED: July 30, 2021

EFFECTIVE: August 22, 2021

BY: Joelle Phillips, President - Tennessee  
Nashville, Tennessee

## E7. SPECIAL ACCESS (A.K.A. BELLSOUTH SPA) SERVICE

### E7.4 Rate Regulations (Cont'd)

#### E7.4.32 BellSouth Metro Ethernet Service (Cont'd)<sup>2</sup>

(C)

##### D. Service Level Agreement for Virtual BellSouth Metro Ethernet service<sup>1</sup> (Cont'd)

###### 1. SLA Definitions

###### BellSouth Metro Ethernet service Time to Repair

- BellSouth Metro Ethernet Service Time-To-Repair measures the outage duration on a customer's BellSouth Metro Ethernet Connection for all CoS. This measure will require the customer to report the problem to the BellSouth repair center.
- The repair interval will start with the time the trouble ticket is created and end when the fault is re-mediated. The Service Level Commitment measurement will be based on each individual trouble ticket for a customer's connection. Time for scheduled maintenance windows (as set forth in E7.4.32.A.3.) does not count towards SLA threshold.

###### BellSouth Metro Ethernet service Network Availability

- BellSouth Metro Ethernet Service Network Availability measures the percentage of time by CoS during a calendar month that the customer's service is unavailable on the core network. The core network is defined as being from the Ethernet switch serving the customer's A-end to the Ethernet switch serving the customer's B-end. Customer networks that do not span more than one switch in the core network are not eligible for the Network Availability SLA, and one will not be provided.
- This Service Level Commitment will be calculated by CoS by measuring and summing the outage for each core network component used by the customer, divided by the total number of components, times the total service time for a particular calendar month. Excluded from the outage time and service time are scheduled maintenance windows (as set forth in E7.4.32.A.3.) and time the network was unavailable due to circumstances outside the Telephone Company's control (as set forth in E7.4.32.D.3.(b)).

###### BellSouth Metro Ethernet service Network Latency

- BellSouth Metro Ethernet Service Network Latency measures average one-way delay in milliseconds within the core network. The core network is defined as being from the Ethernet switch serving the customer's A-end to the Ethernet switch serving the customer's B-end. Customer networks that do not span more than one switch in the core network are not eligible for the Network Latency SLA, and one will not be provided.
- This Service Level Commitment will be calculated for each CoS (except the Best Effort CoS) by averaging the measured latency of simulated traffic for each eligible CoS within the Metro Ethernet Customer Network (i.e., between each pair of connections) during a calendar month.

###### BellSouth Metro Ethernet service Network Jitter

- BellSouth Metro Ethernet Service Jitter measures the average variability, measured in time (milliseconds) between the actual packet transmission rate and the expected packet transmission rate within the core network for Interactive and Real-Time CoS. The core network is defined as being from the Ethernet switch serving the customer's A-end to the Ethernet switch serving the customer's B-end.
- This Service Level Commitment will be calculated for the Interactive CoS and Real-Time CoS by averaging the measured jitter of simulated traffic for each of the customer's eligible CoS queue within the Metro Ethernet Customer Network (i.e., between each pair of connections) during a calendar month.

###### BellSouth Metro Ethernet service Packet Delivery

- BellSouth Metro Ethernet Service Network Packet Delivery measures the percentage of packets conforming to the committed bandwidth profile that are delivered across the core network, without being dropped or lost as a result of a fault within the Virtual Ethernet network. The core network is defined as being from the Ethernet switch serving the customer's A-end to the Ethernet switch serving the customer's B-end.
- This Service Level Commitment will be calculated for each CoS (except the Best Effort CoS) by averaging the measured packet delivery of simulated traffic for eligible CoS within the Metro Ethernet Customer Network (i.e., between each pair of connections) during a calendar month.

**Note 1:** Details of the technical measurements and performance results methodologies for each commitment are provided in BellSouth Technical Reference TR-73632.

**Note 2:** Effective on or after August 22, 2021, this Service will no longer be available for purchase by new or existing customers. In addition, requests to move, add, change, or renew existing service arrangements will not be accepted. Following the expiration of a customer's existing term agreement, service will be provided on a month-to-month basis at the applicable Monthly rates until the service is discontinued. The Company currently plans to discontinue this service on or after March 31, 2023.

(N)

(N)



BELLSOUTH  
TELECOMMUNICATIONS  
TENNESSEE

ACCESS SERVICES TARIFF

First Revised Page 36.15.3  
Cancels Original Page 36.15.3

ISSUED: July 30, 2021

EFFECTIVE: August 22, 2021

BY: Joelle Phillips, President - Tennessee  
Nashville, Tennessee

## E7. SPECIAL ACCESS (A.K.A. BELLSOUTH SPA) SERVICE

### E7.4 Rate Regulations (Cont'd)

#### E7.4.32 BellSouth Metro Ethernet Service (Cont'd)<sup>2</sup>

(C)

**D.** Service Level Agreement for Virtual BellSouth Metro Ethernet service<sup>1</sup> (Cont'd)

2. The Telephone Company's Service Level Commitments for Virtual BellSouth Metro Ethernet service are as follows:

Time to Repair

- Best Effort CoS: 4 hours or less
- Business Critical CoS: 4 hours or less
- Interactive CoS: 4 hours or less
- Real-Time CoS: 4 hours or less

Network Availability

- Best Effort CoS: 99.500% or greater
- Business Critical CoS: 99.995% or greater
- Interactive CoS: 99.995% or greater
- Real-Time CoS: 99.995% or greater

Latency (one-way)

- Best Effort CoS: Not Applicable
- Business Critical CoS: 15 milliseconds or less
- Interactive CoS: 5 milliseconds or less
- Real-Time CoS: 5 milliseconds or less

Jitter

- Best Effort CoS: Not Applicable
- Business Critical CoS: Not Applicable
- Interactive CoS: 1 millisecond or less
- Real-Time CoS: 1 millisecond or less

Packet Delivery

- Best Effort CoS: Not Applicable
- Business Critical CoS: 99.900% or greater
- Interactive CoS: 99.950% or greater
- Real-Time CoS: 99.995% or greater

**Note 1:** Details of the technical measurements and performance results methodologies for each commitment are provided in BellSouth Technical Reference TR-73632.

**Note 2:** Effective on or after August 22, 2021, this Service will no longer be available for purchase by new or existing customers. In addition, requests to move, add, change, or renew existing service arrangements will not be accepted. Following the expiration of a customer's existing term agreement, service will be provided on a month-to-month basis at the applicable Monthly rates until the service is discontinued. The Company currently plans to discontinue this service on or after March 31, 2023.

(N)

(N)

BELLSOUTH  
TELECOMMUNICATIONS  
TENNESSEE

ACCESS SERVICES TARIFF

Second Revised Page 36.15.4  
Cancels First Revised Page 36.15.4

ISSUED: July 30, 2021

EFFECTIVE: August 22, 2021

BY: Joelle Phillips, President - Tennessee  
Nashville, Tennessee

## E7. SPECIAL ACCESS (A.K.A. BELLSOUTH SPA) SERVICE

### E7.4 Rate Regulations (Cont'd)

#### E7.4.32 BellSouth Metro Ethernet Service (Cont'd)<sup>2</sup>

(C)

##### D. Service Level Agreement for Virtual BellSouth Metro Ethernet service<sup>1</sup> (Cont'd)

##### 3. SLA Restrictions

- (a) The Telephone Company will implement SLA provisioning restrictions that will define customer network design requirements and limitations to BellSouth's commitment to meet Service Levels for BellSouth Metro Ethernet Service. The customer network design requirements are as follows:
- A customer must subscribe to the Metro Ethernet Virtual Service with *CNM* - Metro Ethernet Reporting to receive credits for missed Service Level Commitments.
  - Credits are not provided for partial month service.
  - A customer's account must be current to receive a credit.
- (b) SLA Credits do not apply when any stated objective is not met because the Telephone Company does not have control over the circumstances causing the objective to be missed. Situations over which the Telephone Company does not have control include, but are not limited to, the following:
- any act, any omission or negligence on the part of the customer, any other customer or any third party, or of any other entity providing a portion of the service,
  - labor difficulties, governmental orders, civil commotions, acts of civil or military authority, embargoes, epidemics, declared National Emergencies, criminal actions against the Telephone Company, war, terrorist acts, riots, insurrections, fires, explosions, nuclear accidents, power blackouts, acts of God (including, but not limited to, earthquakes, floods or unusually severe weather) or other circumstances beyond the Telephone Company's control,
  - the customer's premises equipment, and
  - unavailability of the customer's facilities and/or equipment including customer-provided power and environmental conditions for BellSouth-owned and operated equipment located on the customer's premises.
- (c) The Customer must request a credit within one month of the Telephone Company missing a BellSouth Metro Ethernet Service Level Commitment. A customer request for a Network Service Level SLA credit must be submitted on a standard request form issued by the Company that includes the month the SLA commitment was missed, accurate identification of the affected circuit, and the observed measurement of the specific SLA that was missed. A customer request for a Repair SLA credit must be submitted on a standard request form issued by the Company that includes the month the SLA commitment was missed, accurate identification of the affected circuit, and the trouble ticket number of the repair request. The Telephone Company will investigate customer requests for any SLA credits to determine the cause of any performance failures reported by the customer. The Telephone Company will investigate the customer's request over a period of up to 45 calendar days. The 45-day period will begin when the customer makes the request for credit with their BellSouth Sales Representative. SLA credits will be provided to the customer if the Company determines that the Telephone Company had control over the circumstances causing the failure.

**Note 1:** Details of the technical measurements and performance results methodologies for each commitment are provided in BellSouth Technical Reference TR-73632.

**Note 2:** Effective on or after August 22, 2021, this Service will no longer be available for purchase by new or existing customers. In addition, requests to move, add, change, or renew existing service arrangements will not be accepted. Following the expiration of a customer's existing term agreement, service will be provided on a month-to-month basis at the applicable Monthly rates until the service is discontinued. The Company currently plans to discontinue this service on or after March 31, 2023.

(N)  
|  
(N)

BELLSOUTH  
TELECOMMUNICATIONS  
TENNESSEE

ACCESS SERVICES TARIFF

Second Revised Page 36.15.5  
Cancels First Revised Page 36.15.5

ISSUED: July 30, 2021

EFFECTIVE: August 22, 2021

BY: Joelle Phillips, President - Tennessee  
Nashville, Tennessee

## E7. SPECIAL ACCESS (A.K.A. BELLSOUTH SPA) SERVICE

### E7.4 Rate Regulations (Cont'd)

#### E7.4.32 BellSouth Metro Ethernet Service (Cont'd)<sup>3</sup>

(C)

##### D. Service Level Agreement for Virtual BellSouth Metro Ethernet service<sup>1</sup> (Cont'd)

##### 4. SLA Credits for Virtual Connections with *CNM* - Metro Ethernet Reporting (Cont'd)

The following credits will apply when the Telephone Company misses a Service Level Commitment on any single CoS (each credit is described in (a) thru (e) following). A maximum of one credit will be applied monthly per Connection for an SLA not met for any CoS that is supported by the customer's CoS profile (i.e., a maximum of one credit is applicable for an SLA even if missed for multiple CoS).

BellSouth Metro Ethernet service Time-To-Repair:

- 0 to 4 hours per incident: No Credit
- Over 4 hours to 24 hours per incident: A credit equal to 3/30 of the monthly recurring charges for all the rate elements<sup>2</sup> associated with the affected Metro Ethernet Connection
- Each additional 24-hour period, per incident: Credit an additional amount equal to 3/30 of the monthly recurring charges for all the rate elements<sup>2</sup> associated with the affected Metro Ethernet Connection

BellSouth Metro Ethernet service Network Availability: A credit equal to 3/30 of the monthly recurring charges for all the rate elements<sup>2</sup> associated with the affected Metro Ethernet Connection

BellSouth Metro Ethernet service Latency: A credit equal to 3/30 of the monthly recurring charges for all the rate elements<sup>2</sup> associated with the affected Metro Ethernet Connection.

BellSouth Metro Ethernet service Jitter: A credit equal to 3/30 of the monthly recurring charges for all the rate elements<sup>2</sup> associated with the affected Metro Ethernet Connection.

BellSouth Metro Ethernet service Packet Delivery: A credit equal to 3/30 of the monthly recurring charges for all the rate elements<sup>2</sup> associated with the affected Metro Ethernet Connection.

**Note 1:** Details of the technical measurements and performance results methodologies for each commitment are provided in BellSouth Technical Reference TR-73632.

**Note 2:** Specifically, rate elements for the Metro Ethernet Connection, Additional Mileage and Features.

**Note 3:** Effective on or after August 22, 2021, this Service will no longer be available for purchase by new or existing customers. In addition, requests to move, add, change, or renew existing service arrangements will not be accepted. Following the expiration of a customer's existing term agreement, service will be provided on a month-to-month basis at the applicable Monthly rates until the service is discontinued. The Company currently plans to discontinue this service on or after March 31, 2023.

(N)  
|  
(N)

BELLSOUTH  
TELECOMMUNICATIONS  
TENNESSEE

ACCESS SERVICES TARIFF

Second Revised Page 36.15.6  
Cancels First Revised Page 36.15.6

ISSUED: July 30, 2021

EFFECTIVE: August 22, 2021

BY: Joelle Phillips, President - Tennessee  
Nashville, Tennessee

## E7. SPECIAL ACCESS (A.K.A. BELLSOUTH SPA) SERVICE

### E7.4 Rate Regulations (Cont'd)

#### E7.4.32 BellSouth Metro Ethernet Service (Cont'd)<sup>4</sup>

(C)

##### D. Service Level Agreement for Virtual BellSouth Metro Ethernet service<sup>1</sup> (Cont'd)

##### 4. SLA Credits for Virtual Connections with *CNM* - Metro Ethernet Reporting (Cont'd)

The SLA credit amount will be determined by applying the credits outlined preceding to the rate elements or total billed revenues specified following:

The total credits issued for all SLAs for a specific BellSouth Metro Ethernet service Connection during a single bill period may not exceed the total monthly recurring charges billed for all the rate elements associated with that BellSouth Metro Ethernet service Connection. Credits are not provided for partial month service.

- (a) BellSouth Metro Ethernet Service Time-To-Repair Credit – The Service Level Commitment measurement will be based on each individual trouble ticket for a customer's connection. Multiple trouble tickets on the same day for the same customer connection will only be eligible for one time-to-repair credit. The SLA credit will apply to the monthly recurring charges for all the rate elements<sup>2</sup> associated with the affected Metro Ethernet Connection
- (b) BellSouth Metro Ethernet Service Network Availability Credit<sup>3</sup> – The Service Level Commitment measurement will be based on a specific calendar month's performance. The credit will apply for each BellSouth Metro Ethernet Service Connection that does not meet the availability commitment. The SLA credit will apply to the monthly recurring charges for all the rate elements<sup>2</sup> associated with the affected Metro Ethernet Connection.
- (c) BellSouth Metro Ethernet Service Latency Credit<sup>3</sup> – The Service Level Commitment measurement will be based on a specific calendar month's performance. The credit will apply for each BellSouth Metro Ethernet Service Connection that does not meet the latency Commitment for any eligible CoS. The SLA credit will apply to the monthly recurring charges for all the rate elements<sup>2</sup> associated with the affected Metro Ethernet Connection.
- (d) BellSouth Metro Ethernet Service Jitter Credit<sup>3</sup> – The Service Level Commitment measurement will be based on a specific calendar month's performance. The credit will apply for each BellSouth Metro Ethernet Service Connection that does not meet the jitter Commitment for any eligible CoS. The SLA credit will apply to the monthly recurring charges for all the rate elements<sup>2</sup> associated with the affected Metro Ethernet Connection.
- (e) BellSouth Metro Ethernet Service Packet Delivery Credit<sup>3</sup> – The Service Level Commitment measurement will be based on a specific calendar month's performance. The credit will apply for each BellSouth Metro Ethernet Service Connection that does not meet the packet delivery commitment for any eligible CoS. The SLA credit will apply to the monthly recurring charges for all the rate elements<sup>2</sup> associated with the affected Metro Ethernet Connection.

**Note 1:** Details of the technical measurements and performance results methodologies for each commitment are provided in BellSouth Technical Reference TR-73632.

**Note 2:** Specifically, rate elements for the Metro Ethernet Connection, Additional Mileage and Features.

**Note 3:** BellSouth Metro Ethernet networks that do not span more than one switch in the core network are not eligible for credits under this SLA.

**Note 4:** Effective on or after August 22, 2021, this Service will no longer be available for purchase by new or existing customers. In addition, requests to move, add, change, or renew existing service arrangements will not be accepted. Following the expiration of a customer's existing term agreement, service will be provided on a month-to-month basis at the applicable Monthly rates until the service is discontinued. The Company currently plans to discontinue this service on or after March 31, 2023.

(N)

(N)

BELLSOUTH  
TELECOMMUNICATIONS  
TENNESSEE

ACCESS SERVICES TARIFF

First Revised Page 36.16  
Cancels Original Page 36.16

ISSUED: March 7, 2019  
BY: Joelle Phillips, President - Tennessee  
Nashville, Tennessee

EFFECTIVE: March 28, 2019

## **E7. SPECIAL ACCESS (A.K.A. BELLSOUTH SPA) SERVICE**

### **E7.5 Rates And Charges**

#### **E7.5.1 Reserved for Future Use**

(T)

(D)

(D)

BELLSOUTH  
TELECOMMUNICATIONS  
TENNESSEE

ACCESS SERVICES TARIFF

Fourth Revised Page 37  
Cancels Third Revised Page 37

ISSUED: March 7, 2019  
BY: Joelle Phillips, President - Tennessee  
Nashville, Tennessee

EFFECTIVE: March 28, 2019

## **E7. SPECIAL ACCESS (A.K.A. BELLSOUTH SPA) SERVICE**

### **E7.5 Rates And Charges (Cont'd)**

(D)

(D)

(T)

(D)

(D)

**E7.5.2 Reserved for Future Use**

BELLSOUTH  
TELECOMMUNICATIONS  
TENNESSEE

ACCESS SERVICES TARIFF

Seventh Revised Page 38  
Cancels Sixth Revised Page 38

ISSUED: June 9, 2021  
BY: Joelle Phillips, President - Tennessee  
Nashville, Tennessee

EFFECTIVE: June 30, 2021

**E7. SPECIAL ACCESS (A.K.A. BELLSOUTH SPA) SERVICE**

**E7.5 Rates And Charges (Cont'd)**

**E7.5.3 Voice Grade (a.k.a. BellSouth SPA DS0 VG)<sup>2</sup> Service**

(C)

**A. Local Channel**

- 1. Per Point of Termination
  - a. Voice Grade (a.k.a. BellSouth SPA DS0 VG)
    - (1) Voice

		Monthly Rate	Nonrecurring Charge		USOC
			First Service Installed	Additional Service Installed	
(a)	Two-Wire	\$33.00	\$258.50	\$110.00	T6E2X
(b)	Four-Wire	55.00	264.00	121.00	T6E4X
(2)	Data				
(a)	Two-Wire	44.00	286.00	132.00	T6E2X
(b)	Four-Wire	60.50	297.00	143.00	T6E4X
(3)	Loop Facilities Not Required <sup>1</sup>				
(a)	Two-Wire	13.20	137.50	79.20	EUC2N
(b)	Four-Wire	13.20	137.50	79.20	EUC4N

**B. Interoffice Channel**

- 1. Mileage Bands

		Fixed Monthly Charge	Monthly Charge Per Mile	Nonrecurring Charge	USOC
(a)	0 mile	\$-	\$-	\$-	1L5XX
(b)	1 thru 8 miles	38.50	2.48	105.60	1L5XX
(c)	9 thru 25 miles	38.50	2.48	105.60	1L5XX
(d)	Over 25 miles	38.50	2.48	105.60	1L5XX

**Note 1:** For connections to Company Centrex Type Services Switches and Equipment considered to be end-user premises.

**Note 2:** Effective June 30, 2021, this Service will no longer be available for purchase by new or existing customers. In addition, requests to move, add, change, or renew existing service arrangements will not be accepted. Following the expiration of a customer's existing term agreement, service will be provided on a month-to-month basis at the applicable Monthly rates until the service is discontinued. The Company currently plans to discontinue this service on or after June 30, 2024.

(N)  
|  
(N)

BELLSOUTH  
TELECOMMUNICATIONS  
TENNESSEE

ACCESS SERVICES TARIFF

Fifth Revised Page 39  
Cancels Fourth Revised Page 39

ISSUED: June 9, 2021

EFFECTIVE: June 30, 2021

BY: Joelle Phillips, President - Tennessee  
Nashville, Tennessee

**E7. SPECIAL ACCESS (A.K.A. BELLSOUTH SPA) SERVICE**

**E7.5 Rates And Charges (Cont'd)**

**E7.5.3 Voice Grade (a.k.a. BellSouth SPA DS0 VG)<sup>1</sup> Service (Cont'd)**

(C)

C. Optional Features and Functions

1. Bridging

a. Voice Bridging, Two-Wire/Four-Wire

(1) Per port

	<b>Monthly Rate</b>	<b>Nonrecurring Charge</b>	<b>USOC</b>
(a) Two-Wire	<i>\$16.50</i>	<i>\$38.50</i>	<b>BCNV2</b>
(b) Four-Wire	<i>17.60</i>	<i>38.50</i>	<b>BCNV4</b>
b. Data Bridging, Two-Wire/Four-Wire			
(1) Per port			
(a) Two-Wire	<i>27.50</i>	<i>41.80</i>	<b>BCND2</b>
(b) Four-Wire	<i>27.50</i>	<i>41.80</i>	<b>BCND4</b>

Note 1: Effective June 30, 2021, this Service will no longer be available for purchase by new or existing customers. In addition, requests to move, add, change, or renew existing service arrangements will not be accepted. Following the expiration of a customer's existing term agreement, service will be provided on a month-to-month basis at the applicable Monthly rates until the service is discontinued. The Company currently plans to discontinue this service on or after June 30, 2024.

(N)  
|  
(N)



BELLSOUTH  
TELECOMMUNICATIONS  
TENNESSEE

ACCESS SERVICES TARIFF

Fifth Revised Page 40  
Cancels Fourth Revised Page 40

ISSUED: June 9, 2021

EFFECTIVE: June 30, 2021

BY: Joelle Phillips, President - Tennessee  
Nashville, Tennessee

**E7. SPECIAL ACCESS (A.K.A. BELLSOUTH SPA) SERVICE**

**E7.5 Rates And Charges (Cont'd)**

**E7.5.3 Voice Grade (a.k.a. BellSouth SPA DS0 VG)<sup>1</sup> Service (Cont'd)**

(C)

C. Optional Features and Functions (Cont'd)

1. Bridging (Cont'd)

c. Telephoto Bridging, Two-Wire/Four-Wire

(1) Per port

	<b>Monthly Rate</b>	<b>Nonrecurring Charge</b>	<b>USOC</b>
(a) Two-Wire	<i>\$16.50</i>	<i>\$38.50</i>	<b>BCNF2</b>
(b) Four-Wire	<i>17.60</i>	<i>38.50</i>	<b>BCNF4</b>
d. DataPhone <sup>®</sup> Select-A-Station Bridging - Primary Data Station Selector			
(1) Sequential Arrangement			
(a) Common Equipment	<i>275.00</i>	<i>247.50</i>	<b>DXNPS</b>
(2) Addressable Arrangement			
(a) Common Equipment	<i>275.00</i>	<i>275.00</i>	<b>DXNPA</b>
(3) Channel Connections			
(a) Per two-wire connection	<i>5.50</i>	<i>39.60</i>	<b>DXNP2</b>
(b) Per four-wire connection	<i>16.50</i>	<i>46.20</i>	<b>DXNP4</b>
e. Dataphone <sup>®</sup> Select-A-Station Bridging - Secondary Data Station Selector			
(1) Sequential Arrangement			
(a) Common Equipment	<i>275.00</i>	<i>247.50</i>	<b>DXNSS</b>
(2) Addressable Arrangement			
(a) Common Equipment	<i>275.00</i>	<i>275.00</i>	<b>DXNSA</b>
(3) Channel Connections			
(a) Per two-wire connection	<i>5.50</i>	<i>39.60</i>	<b>DXNS2</b>
(b) Per four-wire connection	<i>16.50</i>	<i>46.20</i>	<b>DXNS4</b>
f. Telemetry and Alarm Bridging - Split Band, Active Bridging			
(1) Common Equipment, per central office			
(a) First bridging shelf, capacity of 48 two-wire connections	<b>120.00</b>	<b>370.00</b>	<b>DXQC1</b>
(b) Additional bridging shelf, capacity of 56 two-wire connections installed subsequent to the first bridging shelf	<b>120.00</b>	<b>330.00</b>	<b>DXQC2</b>
(c) Additional bridging shelf, capacity of 56 two-wire connections installed at the same as the first bridging shelf	<b>50.00</b>	<b>205.00</b>	<b>XW8</b>

Note 1: Effective June 30, 2021, this Service will no longer be available for purchase by new or existing customers. In addition, requests to move, add, change, or renew existing service arrangements will not be accepted. Following the expiration of a customer's existing term agreement, service will be provided on a month-to-month basis at the applicable Monthly rates until the service is discontinued. The Company currently plans to discontinue this service on or after June 30, 2024.

(N)  
|  
(N)

BELLSOUTH  
TELECOMMUNICATIONS  
TENNESSEE

ACCESS SERVICES TARIFF

Fifth Revised Page 41  
Cancels Fourth Revised Page 41

ISSUED: June 9, 2021

EFFECTIVE: June 30, 2021

BY: Joelle Phillips, President - Tennessee  
Nashville, Tennessee

**E7. SPECIAL ACCESS (A.K.A. BELLSOUTH SPA) SERVICE**

**E7.5 Rates And Charges (Cont'd)**

**E7.5.3 Voice Grade (a.k.a. BellSouth SPA DS0 VG)<sup>1</sup> Service (Cont'd)**

(C)

C. Optional Features and Functions (Cont'd)

1. Bridging (Cont'd)

f. Telemetry and Alarm Bridging - Split Band, Active Bridging (Cont'd)

(2) Channel connections, per channel connected

	Monthly Rate	Nonrecurring Charge	USOC
(a) Remote station channel connection	\$5.00	\$36.00	DXQRX
(b) Mid-link channel connection, first channel	10.00	45.00	DXQM1
(c) Mid-link channel connection, subsequent channels	10.00	45.00	DXQMS

2. Conditioning, Per Point of Termination

	Monthly Rate	Nonrecurring Charge		USOC
		Initial	Subsequent	
(a) C-Type	\$3.30	\$17.60	\$88.00	X1CPT
(b) Improved Attenuation Distortion	93.50	85.80	170.50	UHW
(c) Improved Envelope Delay Distortion	132.00	85.80	170.50	UHY
(d) Sealing Current	1.10	39.60	100.10	1HBPT

3. Echo Control For Effective Two-Wire Service

(1) Per Point of Termination

(a) Improved Return Loss at the Two-Wire Point of Termination	22.00	8.80	269.50	1RL2W
(b) ELEPL2 at the Four-Wire Point of Termination	22.00	7.70	269.50	UHZ

4. Customer Specified Receive Level

(a) Per two-wire or four-wire Point of Termination	-	-	72.60	RLS
--	---	---	-------	-----

5. Reserved For Future Use

6. D-Conditioning

(a) Per point of termination	3.30	11.00	302.50	XDCPT
------------------------------	------	-------	--------	-------

Note 1: Effective June 30, 2021, this Service will no longer be available for purchase by new or existing customers. In addition, requests to move, add, change, or renew existing service arrangements will not be accepted. Following the expiration of a customer's existing term agreement, service will be provided on a month-to-month basis at the applicable Monthly rates until the service is discontinued. The Company currently plans to discontinue this service on or after June 30, 2024.

(N)  
|  
(N)

BELLSOUTH  
TELECOMMUNICATIONS  
TENNESSEE

ACCESS SERVICES TARIFF

Ninth Revised Page 42  
Cancels Eighth Revised Page 42

ISSUED: June 9, 2021  
BY: Joelle Phillips, President - Tennessee  
Nashville, Tennessee

EFFECTIVE: June 30, 2021

**E7. SPECIAL ACCESS (A.K.A. BELLSOUTH SPA) SERVICE**

**E7.5 Rates And Charges (Cont'd)**

**E7.5.3 Voice Grade (a.k.a. BellSouth SPA DS0 VG)<sup>5</sup> Service (Cont'd)**

(C)

C. Optional Features and Functions (Cont'd)

7. Telephoto Conditioning

	Monthly Rate	Nonrecurring Charge		USOC
		Initial	Subsequent	
(a) Per Point of Termination	\$3.30	\$4.40	\$264.00	XTCPT
8. Signaling Capability, per Point of Termination				
(a) Loop <sup>1</sup>	6.60	17.60	280.50	XSS++
(b) Single Frequency	7.70	27.50	291.50	XSSSF
(c) E&M <sup>2</sup>	11.00	28.60	291.50	XSS++
(d) Ground <sup>3</sup>	6.60	12.10	275.00	XSS++
(e) Type C	3.30	16.50	280.50	XSSLC
(f) Other <sup>4</sup>	6.60	22.00	286.00	XSS++
9. Improved Termination				
(a) Per Point of Termination	3.30	4.40	269.50	UGD
10. Simplex Reversal				
(a) Per Point of Termination	-	4.40	104.50	UGJ

**Note 1:** In lieu of ++ substitute LO or LS as appropriate.

**Note 2:** In lieu of ++ substitute EA, EB, EC or CT as appropriate.

**Note 3:** In lieu of ++ substitute GO or GS as appropriate.

**Note 4:** In lieu of ++ substitute LA, LB, LR, RV, DX, DY, EX, AB or AC as appropriate.

**Note 5:** Effective June 30, 2021, this Service will no longer be available for purchase by new or existing customers. In addition, requests to move, add, change, or renew existing service arrangements will not be accepted. Following the expiration of a customer's existing term agreement, service will be provided on a month-to-month basis at the applicable Monthly rates until the service is discontinued. The Company currently plans to discontinue this service on or after June 30, 2024.

(N)

(N)

BELLSOUTH  
TELECOMMUNICATIONS  
TENNESSEE

ACCESS SERVICES TARIFF

Seventh Revised Page 42.1  
Cancels Sixth Revised Page 42.1

ISSUED: June 9, 2021

EFFECTIVE: June 30, 2021

BY: Joelle Phillips, President - Tennessee  
Nashville, Tennessee

## E7. SPECIAL ACCESS (A.K.A. BELLSOUTH SPA) SERVICE

### E7.5 Rates And Charges (Cont'd)

#### E7.5.3 Voice Grade (a.k.a. BellSouth SPA DS0 VG)<sup>1</sup> Service (Cont'd)

(C)

##### C. Optional Features and Functions (Cont'd)

##### D. WATS Access Line (*a.k.a. BellSouth SPA WATS Line*)<sup>1</sup>

(C)

The following apply to a WATS Access Line used for interLATA only calling. Rates for all other WATS Access Lines (*a.k.a. BellSouth SPA WATS Line*) (i.e., combined interLATA/intraLATA calling) are found in the Company's General Subscriber Services Tariff, Section A19.

Note 1: Effective June 30, 2021, this Service will no longer be available for purchase by new or existing customers. In addition, requests to move, add, change, or renew existing service arrangements will not be accepted. Following the expiration of a customer's existing term agreement, service will be provided on a month-to-month basis at the applicable Monthly rates until the service is discontinued. The Company currently plans to discontinue this service on or after June 30, 2024.

(N)

(N)

BELLSOUTH  
TELECOMMUNICATIONS  
TENNESSEE

ACCESS SERVICES TARIFF

Fourth Revised Page 42.2  
Cancels Third Revised Page 42.2

ISSUED: June 9, 2021  
BY: Joelle Phillips, President - Tennessee  
Nashville, Tennessee

EFFECTIVE: June 30, 2021

**E7. SPECIAL ACCESS (A.K.A. BELLSOUTH SPA) SERVICE**

**E7.5 Rates And Charges (Cont'd)**

**E7.5.3 Voice Grade (a.k.a. BellSouth SPA DS0 VG)<sup>2</sup> Service (Cont'd)**

(C)

**D. WATS Access Line (a.k.a. BellSouth SPA WATS Line)<sup>2</sup> (Cont'd)**

(C)

1. Two-Wire/Four-Wire WATS Access Line

a. Local Channels

(1) Per Point of Termination

	Monthly Rate	Nonrecurring Charge		USOC
		First Service Installed	Additional Service Installed	
(a) Per Two-Wire Line	<i>\$44.00</i>	<i>\$258.50</i>	<i>\$110.00</i>	X2W
(b) Per Two-Wire Line <sup>1</sup>	<i>44.00</i>	<i>258.50</i>	<i>110.00</i>	X2L
(c) Per Four-Wire Line <sup>1</sup>	<i>60.50</i>	<i>264.00</i>	<i>121.00</i>	X4W
(d) Per Four-Wire Line <sup>1</sup>	<i>60.50</i>	<i>264.00</i>	<i>121.00</i>	X4L

**Note 1:** For use with Direct Inward Dial (DID) or DID/DOD Access Service with BSA for use with Dedicated Access Lines described in E6.3.5.A. and provided in E6.8.3.A.6. of this Tariff.

**Note 2:** Effective June 30, 2021, this Service will no longer be available for purchase by new or existing customers. In addition, requests to move, add, change, or renew existing service arrangements will not be accepted. Following the expiration of a customer's existing term agreement, service will be provided on a month-to-month basis at the applicable Monthly rates until the service is discontinued. The Company currently plans to discontinue this service on or after June 30, 2024.

(N)

(N)

BELLSOUTH  
TELECOMMUNICATIONS  
TENNESSEE

ACCESS SERVICES TARIFF

Sixth Revised Page 43  
Cancels Fifth Revised Page 43

ISSUED: December 9, 2022  
BY: Joelle Phillips, President - Tennessee  
Nashville, Tennessee

EFFECTIVE: January 1, 2023

**E7. SPECIAL ACCESS (A.K.A.BELLSOUTH SPA) SERVICE**

**E7.5 Rates And Charges (Cont'd)**

**E7.5.3 Voice Grade (a.k.a. BellSouth SPA DS0 VG)<sup>2</sup> (Cont'd)**

**D. WATS Access Line (a.k.a. BellSouth SPA WATS Line)<sup>2</sup> (Cont'd)**

- 2. Interoffice Channel
  - a. Mileage Bands
    - (1) Fixed Rate

	<b>Fixed Monthly Charge</b>	<b>Monthly Charge Per Mile</b>	<b>Nonrecurring Charge</b>	<b>USOC</b>
(a) 0 mile	\$-	\$-	\$-	1LFFX
(b) 1 thru 8 miles	33.00	2.26	102.30	1LFFX
(c) 9 thru 25 miles	33.00	2.20	102.30	1LFFX
(d) Over 25 miles	33.00	2.15	102.30	1LFFX

- 3. Optional Features
  - a. Improved Two-Wire Voice Transmission Specifications
    - (1) For WATS Access Line (a.k.a. BellSouth SPA WATS Line)

	<b>Monthly Rate</b>	<b>Nonrecurring Charge</b>		<b>USOC</b>
		<b>Initial</b>	<b>Subsequent</b>	
(a) Two-Wire	\$22.00	\$37.40	\$90.20	X2T

- b. WATS Access Line Bridging
  - (1) Two-Wire/Four-Wire, per port

	<b>Monthly Rate</b>	<b>Nonrecurring Charge</b>	<b>USOC</b>
(a) Two-Wire	\$13.20	\$38.50	BCNV2
(b) Four-Wire	15.40	38.50	BCNV4

**E7.5.4 Reserved For Future Use**

(T)  
(D)

Note 1: *(DELETED)*

Note 2: Effective June 30, 2021, this Service will no longer be available for purchase by new or existing customers. In addition, requests to move, add, change, or renew existing service arrangements will not be accepted. Following the expiration of a customer's existing term agreement, service will be provided on a month-to-month basis at the applicable Monthly rates until the service is discontinued. The Company currently plans to discontinue this service on or after June 30, 2024.

(T)

BELLSOUTH  
TELECOMMUNICATIONS  
TENNESSEE

ACCESS SERVICES TARIFF

Sixth Revised Page 44  
Cancels Fifth Revised Page 44

ISSUED: December 9, 2022  
BY: Joelle Phillips, President - Tennessee  
Nashville, Tennessee

EFFECTIVE: January 1, 2023

## **E7. SPECIAL ACCESS (A.K.A. BELLSOUTH SPA) SERVICE**

### **E7.5 Rates And Charges (Cont'd)**

**E7.5.4 *Reserved For Future Use* (Cont'd)**

(T)

(D)

**E7.5.5 Reserved For Future Use**

**E7.5.6 Reserved For Future Use**

(D)

BELLSOUTH  
TELECOMMUNICATIONS  
TENNESSEE

ACCESS SERVICES TARIFF

Ninth Revised Page 45  
Cancels Eighth Revised Page 45

ISSUED: June 9, 2021  
BY: Joelle Phillips, President - Tennessee  
Nashville, Tennessee

EFFECTIVE: June 30, 2021

**E7. SPECIAL ACCESS (A.K.A. BELLSOUTH SPA) SERVICE**

**E7.5 Rates And Charges (Cont'd)**

**E7.5.7 Digital Data Access (a.k.a. BellSouth SPA DS0 Digital Data)<sup>3</sup> Service**

(C)

**A. Local Channel**

1. Per Point of Termination

	Nonrecurring Charge		Month	24 to	43 to	USOC
	First	Add'l	to	42	60	
			Month	Months <sup>1,2</sup>	Months <sup>1,2</sup>	
(a) 2.4 Kbps	\$330.00	\$115.00	\$55.00	\$49.00	\$47.00	T6ECS
(b) 4.8 Kbps	330.00	115.00	55.00	49.00	47.00	T6ECS
(c) 9.6 Kbps	330.00	115.00	55.00	49.00	47.00	T6ECS
(d) 19.2 Kbps	330.00	115.00	55.00	49.00	47.00	T6ECS
(e) 56.0 Kbps	330.00	115.00	75.00	65.00	60.00	T6ECS
(f) 64.0 Kbps	330.00	115.00	75.00	65.00	60.00	T6ECS

2. Hub Termination, per Local Channel

(a) 2.4 Kbps	61.00	54.00	10.00	9.75	9.50	TUTA4
(b) 4.8 Kbps	61.00	54.00	10.00	9.75	9.50	TUTB4
(c) 9.6 Kbps	61.00	54.00	10.00	9.75	9.50	TUTC4
(d) 19.2 Kbps	61.00	54.00	10.00	9.75	9.50	TUTE4
(e) 56.0 Kbps	61.00	54.00	30.00	28.00	26.00	TUTD4
(f) 64.0 Kbps	61.00	54.00	30.00	28.00	26.00	TUTF4

**B. Interoffice Channel**

1. 2.4 Kbps

**Mileage Bands**

	Fixed Monthly Charge	Monthly Charge Per Mile	Nonrecurring Charge	USOC
(a) 0 mile	\$-	\$-	\$-	1L5XX
(b) 1 thru 8 miles	20.00	2.05	39.00	1L5XX
(c) 9 thru 25 miles	20.00	2.00	39.00	1L5XX
(d) Over 25 miles	20.00	1.95	39.00	1L5XX

**Note 1:** Effective November 9th, 2013, customers may not establish new term plans greater than 36 months for Digital Data Access Service and term plans may not be renewed for a term greater than 36 months.

**Note 2:** Effective March 28, 2019, Customers may not convert, renew or establish CSPPs for Digital Data Access Service.

**Note 3:** Effective June 30, 2021, this Service will no longer be available for purchase by new or existing customers. In addition, requests to move, add, change, or renew existing service arrangements will not be accepted. Following the expiration of a customer's existing term agreement, service will be provided on a month-to-month basis at the applicable Monthly rates until the service is discontinued. The Company currently plans to discontinue this service on or after June 30, 2024.

(N)  
|  
(N)



BELLSOUTH  
TELECOMMUNICATIONS  
TENNESSEE

ACCESS SERVICES TARIFF

Sixth Revised Page 46  
Cancels Fifth Revised Page 46

ISSUED: June 9, 2021

EFFECTIVE: June 30, 2021

BY: Joelle Phillips, President - Tennessee  
Nashville, Tennessee

**E7. SPECIAL ACCESS (A.K.A. BELLSOUTH SPA) SERVICE**

**E7.5 Rates And Charges (Cont'd)**

**E7.5.7 Digital Data Access (a.k.a. BellSouth SPA DS0 Digital Data)<sup>1</sup> Service Cont'd**

(C)

2. 4.8 Kbps

**Mileage Bands**

	<b>Fixed Monthly Charge</b>	<b>Monthly Charge Per Mile</b>	<b>Nonrecurring Charge</b>	<b>USOC</b>
(a) 0 mile	\$-	\$-	\$-	1L5XX
(b) 1 thru 8 miles	20.00	2.05	39.00	1L5XX
(c) 9 thru 25 miles	20.00	2.00	39.00	1L5XX
(d) Over 25 miles	20.00	1.95	39.00	1L5XX

3. 9.6 Kbps

**Mileage Bands**

(a) 0 mile	-	-	-	1L5XX
(b) 1 thru 8 miles	20.00	2.05	39.00	1L5XX
(c) 9 thru 25 miles	20.00	2.00	39.00	1L5XX
(d) Over 25 miles	20.00	1.95	39.00	1L5XX

4. 19.2 Kbps

**Mileage Bands**

(a) 0 mile	-	-	-	1L5XX
(b) 1 thru 8 miles	20.00	2.05	39.00	1L5XX
(c) 9 thru 25 miles	20.00	2.00	39.00	1L5XX
(d) Over 25 miles	20.00	1.95	39.00	1L5XX

Note 1: Effective June 30, 2021, this Service will no longer be available for purchase by new or existing customers. In addition, requests to move, add, change, or renew existing service arrangements will not be accepted. Following the expiration of a customer's existing term agreement, service will be provided on a month-to-month basis at the applicable Monthly rates until the service is discontinued. The Company currently plans to discontinue this service on or after June 30, 2024.

(N)

(N)

BELLSOUTH  
TELECOMMUNICATIONS  
TENNESSEE

ACCESS SERVICES TARIFF

Ninth Revised Page 47  
Cancels Eighth Revised Page 47

ISSUED: June 9, 2021  
BY: Joelle Phillips, President - Tennessee  
Nashville, Tennessee

EFFECTIVE: June 30, 2021

**E7. SPECIAL ACCESS (A.K.A.BELLSOUTH SPA) SERVICE**

**E7.5 Rates And Charges (Cont'd)**

**E7.5.7 Digital Data Access (a.k.a. BellSouth SPA DS0 Digital Data)<sup>4</sup> Service (Cont'd)**

(C)

**B. Interoffice Channel (Cont'd)**

5. 56 Kbps

**Mileage Bands**

		<b>Fixed Monthly Charge</b>	<b>Monthly Charge Per Mile</b>	<b>Nonrecurring Charge</b>	<b>USOC</b>
(a)	0 mile	\$-	\$-	\$-	1L5XX
(b)	1 thru 8 miles	40.00	4.10	39.00	1L5XX
(c)	9 thru 25 miles	40.00	4.00	39.00	1L5XX
(d)	Over 25 miles	40.00	3.90	39.00	1L5XX

6. 64.0 Kbps

**Mileage Bands**

(a)	0 mile	-	-	-	1L5XX
(b)	1 thru 8 miles	40.00	4.10	39.00	1L5XX
(c)	9 thru 25 miles	40.00	4.00	39.00	1L5XX
(d)	Over 25 miles	40.00	3.90	39.00	1L5XX

7. 2.4, 4.8, 9.6, or 19.2 Kbps (Contract Rates)

**Mileage Bands**

		<b>Fixed</b>		<b>Per Mile</b>			
		<b>Nonrecurring Charge</b>	<b>24 to 42 Months<sup>2,3</sup></b>	<b>43 to 60 Months<sup>2,3</sup></b>	<b>24 to 42 Months<sup>2,3</sup></b>	<b>43 to 60 Months<sup>2,3</sup></b>	<b>USOC</b>
		<b>Per Channel</b>					
(a)	0 mile	\$-	\$-	\$-	\$-	\$-	1L5XX
(b)	1 thru 8 miles	39.00	19.50	19.00	1.90	1.75	1L5XX
(c)	9 thru 25 miles	39.00	19.50	19.00	1.85	1.70	1L5XX
(d)	Over 25 miles	39.00	19.50	19.00	1.80	1.65	1L5XX

8. 56.0 or 64.0 Kbps (Contract Rates)

**Mileage Bands**

(a)	0 mile	-	-	-	-	-	1L5XX
(b)	1 thru 8 miles	39.00	36.00	34.00	3.80	3.50	1L5XX
(c)	9 thru 25 miles	39.00	36.00	34.00	3.70	3.40	1L5XX
(d)	Over 25 miles	39.00	36.00	34.00	3.60	3.30	1L5XX

**C. Optional Features and Functions**

1. Bridging<sup>1</sup>

		<b>Nonrecurring Charge</b>	<b>Month to Month</b>	<b>24 to 42 Months<sup>2,3</sup></b>	<b>43 to 60 Months<sup>2,3</sup></b>	<b>USOC</b>
(a)	2.4, 4.8, 9.6, 19.2, 56.0 Kbps	\$25.00	\$25.00	\$24.00	\$22.00	BCNDA

**Note 1:** The option is not available with 64.0 Kbps.

**Note 2:** Effective December 16, 2013, Customers may not establish new term plans greater than 36 months for Digital Data service and term plans may not be renewed for a term greater than 36 months.

**Note 3:** Effective March 28, 2019, Customers may not convert, renew or establish CSPPs for Digital Data Access Service.

**Note 4:** Effective June 30, 2021, this Service will no longer be available for purchase by new or existing customers. In addition, requests to move, add, change, or renew existing service arrangements will not be accepted. Following the expiration of a customer's existing term agreement, service will be provided on a month-to-month basis at the applicable Monthly rates until the service is discontinued. The Company currently plans to discontinue this service on or after June 30, 2024.

(N)  
|  
(N)

BELLSOUTH  
TELECOMMUNICATIONS  
TENNESSEE

ACCESS SERVICES TARIFF

Eighth Revised Page 47.1  
Cancels Seventh Revised Page 47.1

ISSUED: June 9, 2021  
BY: Joelle Phillips, President - Tennessee  
Nashville, Tennessee

EFFECTIVE: June 30, 2021

**E7. SPECIAL ACCESS (A.K.A. BELLSOUTH SPA) SERVICE**

**E7.5 Rates And Charges (Cont'd)**

**E7.5.7 Digital Data Access (a.k.a. BellSouth SPA DS0 Digital Data)<sup>5</sup> Service (Cont'd)**

(C)

- C. Optional Features and Functions (Cont'd)
  - 2. Digital Data Secondary Channel Capability, per Local Channel

(a) Each <sup>1,2</sup>	<table border="0"> <tr> <td style="text-align: center;"><b>Nonrecurring</b></td> <td style="text-align: center;"><b>Month</b></td> <td style="text-align: center;"><b>24 to</b></td> <td style="text-align: center;"><b>43 to</b></td> <td></td> </tr> <tr> <td style="text-align: center;"><b>Charge</b></td> <td style="text-align: center;"><b>to</b></td> <td style="text-align: center;"><b>42</b></td> <td style="text-align: center;"><b>60</b></td> <td style="text-align: center;"><b>USOC</b></td> </tr> <tr> <td style="text-align: center;"><b>\$190.00</b></td> <td style="text-align: center;"><b>Month</b></td> <td style="text-align: center;"><b>Months<sup>3,4</sup></b></td> <td style="text-align: center;"><b>Months<sup>3,4</sup></b></td> <td style="text-align: center;"><b>SFS</b></td> </tr> </table>	<b>Nonrecurring</b>	<b>Month</b>	<b>24 to</b>	<b>43 to</b>		<b>Charge</b>	<b>to</b>	<b>42</b>	<b>60</b>	<b>USOC</b>	<b>\$190.00</b>	<b>Month</b>	<b>Months<sup>3,4</sup></b>	<b>Months<sup>3,4</sup></b>	<b>SFS</b>
<b>Nonrecurring</b>	<b>Month</b>	<b>24 to</b>	<b>43 to</b>													
<b>Charge</b>	<b>to</b>	<b>42</b>	<b>60</b>	<b>USOC</b>												
<b>\$190.00</b>	<b>Month</b>	<b>Months<sup>3,4</sup></b>	<b>Months<sup>3,4</sup></b>	<b>SFS</b>												

**Note 1:** This option is not available with 64.0 Kbps.

**Note 2:** Nonrecurring charge is applicable only if Secondary Channel Service is being added subsequent to the installation of basic service.

**Note 3:** Effective November 9th, 2013, customers may not establish new term plans greater than 36 months for Digital Data Access Service and term plans may not be renewed for a term greater than 36 months.

**Note 4:** Effective March 28, 2019, Customers may not convert, renew or establish CSPPs for Digital Data Access Service.

**Note 5:** Effective June 30, 2021, this Service will no longer be available for purchase by new or existing customers. In addition, requests to move, add, change, or renew existing service arrangements will not be accepted. Following the expiration of a customer's existing term agreement, service will be provided on a month-to-month basis at the applicable Monthly rates until the service is discontinued. The Company currently plans to discontinue this service on or after June 30, 2024.

(N)  
|  
(N)

BELLSOUTH  
TELECOMMUNICATIONS  
TENNESSEE

ACCESS SERVICES TARIFF

Fifth Revised Page 47.2  
Cancels Fourth Revised Page 47.2

ISSUED: September 6, 2012  
BY: Joelle Phillips, President - Tennessee  
Nashville, Tennessee

EFFECTIVE: September 27, 2012

**E7. SPECIAL ACCESS (A.K.A. BELLSOUTH SPA) SERVICE**

**E7.5 Rates And Charges (Cont'd)**

**E7.5.7 Digital Data Access (a.k.a. BellSouth SPA DS0 Digital Data) Service (Cont'd)**

**C. Optional Features and Functions (Cont'd)**

(D)

(D)

BELLSOUTH  
 TELECOMMUNICATIONS  
 TENNESSEE  
 ISSUED: February 23, 2024  
 BY: President - Tennessee  
 Nashville, Tennessee

ACCESS SERVICES TARIFF

Fourteenth Revised Page 48  
 Cancels Thirteenth Revised Page 48

EFFECTIVE: March 17, 2024

**E7. SPECIAL ACCESS (A.K.A. BELLSOUTH SPA) SERVICE**

**E7.5 Rates And Charges (Cont'd)**

**E7.5.8 High Capacity (a.k.a. BellSouth SPA High Capacity) Service**

**A. Local Channel**

1. Per Point of Termination

		Nonrecurring Charge		
	Monthly Rate	First Service Installed	Additional Service Installed	USOC
(a) 1.544 Mbps	\$106.00	\$735.00	\$335.00	TMECS
(b) 3.152 Mbps <sup>1</sup>	-	-	-	TWT++
(c) 6.312 Mbps <sup>1</sup>	-	-	-	TWT++
(d) 44.736 Mbps <sup>1</sup>	-	-	-	TWT++

2. Contract Rates Per Point Of Termination<sup>2</sup>

	Nonrecurring First	Charge Additional	24 to 48 Months <sup>3,4,5,6</sup>	49 to 72 Months <sup>3,4,5</sup>	73 to 96 Months <sup>3,4,5</sup>	USOC
(a) 1.544 Mbps	\$735.00	\$335.00	\$106.00	\$104.00	\$102.00	TMECS

**B. Interoffice Channel**

1. 1.544 Mbps

**Mileage Bands**

	Fixed Monthly Charge	Monthly Charge Per Mile	Nonrecurring Charge	USOC
(a) 0 mile	\$-	\$-	\$-	1L5XX
(b) 1 thru 8 miles	75.00	45.50	290.00	1L5XX
(c) 9 thru 25 miles	75.00	45.50	290.00	1L5XX
(d) Over 25 miles	75.00	45.50	290.00	1L5XX

**Note 1:** ICB rates and charges apply.

**Note 2:** Contract lengths are flexible to allow customer choice of payment period per E2.4.9.

**Note 3:** Effective December 16, 2013, Customers may not establish new term plans greater than 36 months for Digital Data service and term plans may not be renewed for a term greater than 36 months.

**Note 4:** Effective March 28, 2019, Customers may not convert or renew CSPPs for High Capacity Service.

**Note 5:** Effective November 1, 2022, customers may not establish new term plans of greater than 24 months for High Capacity Service Channel Service Payment Plans.

**Note 6:** Effective March 17, 2024, customers may not establish new term plans of greater than month-to-month for High Capacity Service Channel Service Payment Plans. (N)

BELLSOUTH  
 TELECOMMUNICATIONS  
 TENNESSEE  
 ISSUED: February 23, 2024  
 BY: President - Tennessee  
 Nashville, Tennessee

ACCESS SERVICES TARIFF

Eighth Revised Page 48.1  
 Cancels Seventh Revised Page 48.1

EFFECTIVE: March 17, 2024

**E7. SPECIAL ACCESS (A.K.A. BELLSOUTH SPA) SERVICE**

**E7.5 Rates And Charges (Cont'd)**

**E7.5.8 High Capacity (a.k.a. BellSouth SPA High Capacity) Service (Cont'd)**

- B. Interoffice Channel (Cont'd)
  - 2. 1.544 Mbps (Contract Rates)<sup>1,2</sup>

**Mileage Bands**

		Nonrecurring Charge	Fixed			USOC
			Monthly Charge	24 to 48 Months <sup>3,4,5,6</sup>	49 to 72 Months <sup>3,4,5</sup>	
(a)	0 mile	\$-	\$-	\$-	\$-	1L5XX
(b)	1 thru 8 miles	290.00	65.00	18.00	16.00	14.00 1L5XX
(c)	9 thru 25 miles	290.00	65.00	18.00	16.00	14.00 1L5XX
(d)	Over 25 miles	290.00	65.00	18.00	16.00	14.00 1L5XX

(C)

**Note 1:** Contract lengths are now flexible to allow customer choice of payment period per E2.4.9.

**Note 2:** Monthly rates are per mile.

**Note 3:** Effective December 16, 2013, Customers may not establish new term plans greater than 36 months for High Capacity Service and term plans may not be renewed for a term greater than 36 months.

**Note 4:** Effective March 28, 2019, Customers may not convert or renew CSPPs for High Capacity Service.

**Note 5:** Effective November 1, 2022, customers may not establish new term plans of greater than 24 months for High Capacity Service Channel Service Payment Plans.

**Note 6:** Effective March 17, 2024, customers may not establish new term plans of greater than month-to-month for High Capacity Service Channel Service Payment Plans. (N)

BELLSOUTH  
 TELECOMMUNICATIONS  
 TENNESSEE

ACCESS SERVICES TARIFF

Fifth Revised Page 49  
 Cancels Fourth Revised Page 49

ISSUED: February 24, 1997  
 BY: Joelle Phillips, President - Tennessee  
 Nashville, Tennessee

EFFECTIVE: March 26, 1997

**E7. SPECIAL ACCESS (A.K.A. BELLSOUTH SPA) SERVICE** (T)

**E7.5 Rates And Charges (Cont'd)**

**E7.5.8 High Capacity (a.k.a. BellSouth SPA High Capacity) Service (Cont'd)** (T)

**B. Interoffice Channel (Cont'd)**

3. 3.152 Mbps

**Mileage Bands**

	<b>Fixed Monthly Charge</b>	<b>Monthly Charge Per Mile</b>	<b>Nonrecurring Charge</b>	<b>USOC 1LOXX</b>
(a) 0 mile	\$-	\$-	\$-	1LOXX
(b) 1 thru 8 miles <sup>1</sup>	-	-	-	1LOXX
(c) 9 thru 25 miles <sup>1</sup>	-	-	-	1LOXX
(d) Over 25 miles <sup>1</sup>	-	-	-	1LOXX

**Note 1:** ICB rates and charges apply.

BELLSOUTH  
TELECOMMUNICATIONS  
TENNESSEE

ACCESS SERVICES TARIFF

Sixth Revised Page 50  
Cancels Fifth Revised Page 50

ISSUED: February 24, 1997  
BY: Joelle Phillips, President - Tennessee  
Nashville, Tennessee

EFFECTIVE: March 26, 1997

**E7. SPECIAL ACCESS (A.K.A. BELLSOUTH SPA) SERVICE** (T)

**E7.5 Rates And Charges (Cont'd)**

**E7.5.8 High Capacity (a.k.a. BellSouth SPA High Capacity) Service (Cont'd)** (T)

**B. Interoffice Channel (Cont'd)**

4. 6.312 Mbps

**Mileage Bands**

		<b>Fixed Monthly Charge</b>	<b>Monthly Charge Per Mile</b>	<b>Nonrecurring Charge</b>	<b>USOC 1LOXX</b>
(a)	0 mile	\$-	\$-	\$-	1LOXX
(b)	1 thru 8 miles <sup>1</sup>	-	-	-	1LOXX
(c)	9 thru 25 miles <sup>1</sup>	-	-	-	1LOXX
(d)	Over 25 miles <sup>1</sup>	-	-	-	1LOXX

5. 44.736 Mbps

**Mileage Bands**

(a)	0 mile	-	-	-	1LOXX
(b)	1 thru 8 miles <sup>1</sup>	-	-	-	1LOXX
(c)	9 thru 25 miles <sup>1</sup>	-	-	-	1LOXX
(d)	Over 25 miles <sup>1</sup>	-	-	-	1LOXX

**Note 1:** ICB rates and charges apply.



BELLSOUTH  
TELECOMMUNICATIONS  
TENNESSEE

ACCESS SERVICES TARIFF

Eighth Revised Page 51  
Cancels Seventh Revised Page 51

ISSUED: June 9, 2021  
BY: Joelle Phillips, President - Tennessee  
Nashville, Tennessee

EFFECTIVE: June 30, 2021

**E7. SPECIAL ACCESS (A.K.A. BELLSOUTH SPA) SERVICE**

**E7.5 Rates And Charges (Cont'd)**

**E7.5.8 High Capacity (a.k.a. BellSouth SPA High Capacity) Service (Cont'd)**

C. Optional Features and Functions

1. Channelization

a. DS3 Channelization

(1) DS3 to DS1

(a) Per arrangement<sup>1</sup>

b. DS2 Channelization

(1) DS2 to DS1

(a) Per arrangement<sup>1</sup>

c. DS1C Channelization

(1) DS1C to DS1

(a) Per arrangement<sup>1</sup>

d. DS1 Channelization

(1) DS1 Basic Channelization System (DS1 to VG/DS0)

(a) Per system

e. DS0 Channelization<sup>2</sup>

(1) DS0 Basic Channelization System (DS0 to Subrate)  
(Per system)

(a) Maximum of 20, 2.4 Kbps services

(b) Maximum of 10, 4.8 Kbps services

(c) Maximum of 5, 9.6 Kbps services

	Monthly Rate	Nonrecurring Charge	USOC
(a) Per arrangement <sup>1</sup>	\$-	\$-	MXB++
(a) Per arrangement <sup>1</sup>	-	-	MXD++
(a) Per arrangement <sup>1</sup>	-	-	MXH++
(a) Per system	210.00	140.00	MQ1
(a) Maximum of 20, 2.4 Kbps services	120.00	140.00	QSU24
(b) Maximum of 10, 4.8 Kbps services	120.00	140.00	QSU48
(c) Maximum of 5, 9.6 Kbps services	120.00	140.00	QSU96

**Note 1:** ICB rates and charges apply.

**Note 2:** Effective June 30, 2021, this Service will no longer be available for purchase by new or existing customers. In addition, requests to move, add, change, or renew existing service arrangements will not be accepted. Following the expiration of a customer's existing term agreement, service will be provided on a month-to-month basis at the applicable Monthly rates until the service is discontinued. The Company currently plans to discontinue this service on or after June 30, 2024.

(C)

(N)

(N)

BELLSOUTH  
 TELECOMMUNICATIONS  
 TENNESSEE  
 ISSUED: February 23, 2024  
 BY: President - Tennessee  
 Nashville, Tennessee

ACCESS SERVICES TARIFF

Thirteenth Revised Page 51.0.1  
 Cancels Twelfth Revised Page 51.0.1

EFFECTIVE: March 17, 2024

**E7. SPECIAL ACCESS (A.K.A. BELLSOUTH SPA) SERVICE**

**E7.5 Rates And Charges (Cont'd)**

**E7.5.8 High Capacity (a.k.a. BellSouth SPA High Capacity) Service (Cont'd)**

C. Optional Features and Functions (Cont'd)

2. Channel Interfaces (Per Interface)

a. Sub-DS3 Interfaces

(1) DS1 Level Central Office Channel Interface<sup>1</sup>

	Month to Month	24 to 48 Months <sup>2,3,6,7</sup>	49 to 72 Months <sup>2,3,6</sup>	73 to 96 Months <sup>2,3,6</sup>	Nonrecurring Charge	USOC
(a) Asynchronous	\$12.00	\$8.00	\$7.00	\$6.00	\$155.00	1D3CA
(b) Synchronous	36.00	31.00	28.00	25.00	135.00	1D3CS
(2) DS1 Level Customer Channel Interface <sup>1</sup>						
(a) Asynchronous	17.00	13.00	13.00	13.00	305.00	1D3DA
(b) Synchronous	45.00	36.00	33.00	30.00	255.00	1D3DS

b. Sub-DS1 Interfaces

(1) VG/DS0 Level Central Office Channel Interface

	Monthly Rate	Nonrecurring Charge First	Additional	USOC
(a) BellSouth SWA	\$0.00	\$0.00	\$0.00	1D1SW
(b) Reserved for Future Use				
(c) Reserved for Future Use				
(d) Voice Grade (BellSouth SPA DSO VG) <sup>5</sup>	6.50	7.00	6.00	1D1VG
(e) WATS Access Line (BellSouth SPA WATS Line) <sup>5</sup>	6.50	7.00	6.00	1D1WT
(f) <b>(DELETED)</b>				
(g) <b>(DELETED)</b>				
(h) DDAS (BellSouth SPA DSO Digital Data) <sup>5</sup>	13.00	7.00	6.00	1D1DD

(c) Sub-DS0 Interfaces

(1) Subrate Level Central Office Channel Interface<sup>5</sup>

(a) Subrate (2.4, 4.8 & 9.6 Kbps)	13.00	7.00	6.00	1DOSR
-----------------------------------	-------	------	------	-------

3. Reserved for Future Use

**Note 1:** Contract rates are flexible to allow customer choice of payment period per E2.4.9.

**Note 2:** Effective November 9th, 2013, customers may not establish new term plans greater than 36 months for High Capacity Service and term plans may not be renewed for a term greater than 36 months.

**Note 3:** Effective March 28, 2019, Customers may not convert or renew CSPPs for High Capacity Service.

**Note 4:** **(DELETED)**

**Note 5:** Effective June 30, 2021, this Service will no longer be available for purchase by new or existing customers. In addition, requests to move, add, change, or renew existing service arrangements will not be accepted. Following the expiration of a customer's existing term agreement, service will be provided on a month-to-month basis at the applicable Monthly rates until the service is discontinued. The Company currently plans to discontinue this service on or after June 30, 2024.

**Note 6:** Effective November 1, 2022, customers may not establish new term plans of greater than 24 months for High Capacity Service Channel Service Payment Plans.

**Note 7:** Effective March 17, 2024, customers may not establish new term plans of greater than month-to-month for High Capacity Service Channel Service Payment Plans. (N)

BELLSOUTH  
TELECOMMUNICATIONS  
TENNESSEE

ACCESS SERVICES TARIFF

Ninth Revised Page 51.1  
Cancels Eighth Revised Page 51.1

ISSUED: July 8, 1999  
BY: Joelle Phillips, President - Tennessee  
Nashville, Tennessee

EFFECTIVE: August 8, 1999

**E7. SPECIAL ACCESS (A.K.A. BELLSOUTH SPA) SERVICE** (T)

**E7.5 Rates And Charges (Cont'd)**

**E7.5.8 High Capacity (a.k.a. BellSouth SPA High Capacity) Service (Cont'd)** (T)

C. Optional Features and Functions (Cont'd)

4. Clear Channel Capability is furnished on a per DS1 service channel basis.

Per DS1/1.544 Mbps High Capacity Channel optioned as:

		Monthly	Nonrecurring		
		Rate	Initial	Subsequent	USOC
(a)	Superframe Format (SF)	\$-	\$-	\$590.00	CCOSF
(b)	Extended Superframe Format (ESF)	-	-	590.00	CCOEF
5.	Virtual Collocation to High Capacity (a.k.a. BellSouth SPA HighCapacity) Service				
(a)	Per DS1 Cross-Connect	7.50	155.00	14.00	CNC1X

(N)

(N)

BELLSOUTH  
TELECOMMUNICATIONS  
TENNESSEE

ACCESS SERVICES TARIFF

Fourth Revised Page 51.2  
Cancels Third Revised Page 51.2

ISSUED: February 24, 1997  
BY: Joelle Phillips, President - Tennessee  
Nashville, Tennessee

EFFECTIVE: March 26, 1997

**E7. SPECIAL ACCESS (A.K.A. BELLSOUTH SPA) SERVICE**

(T)

**E7.5 Rates And Charges (Cont'd)**

**E7.5.8 High Capacity (a.k.a. BellSouth SPA High Capacity) Service (Cont'd)**

(T)

**C. Optional Features and Functions (Cont'd)**

BELLSOUTH  
TELECOMMUNICATIONS  
TENNESSEE

ACCESS SERVICES TARIFF

Ninth Revised Page 52  
Cancels Eighth Revised Page 52

ISSUED: July 8, 2003  
BY: Joelle Phillips, President - Tennessee  
Nashville, Tennessee

EFFECTIVE: August 8, 2003

**E7. SPECIAL ACCESS (A.K.A. BELLSOUTH SPA) SERVICE**

**E7.5 Rates And Charges (Cont'd)**

**E7.5.9 Message Station Equipment Recovery Charge**

- A. Message Station Equipment Recovery Charge
  - 1. Per Special Access (a.k.a. BellSouth SPA) Surcharge Assessed

<b>Monthly</b>	<b>USOC</b>
<b>Rate</b>	<b>UTM</b>
<b>\$4.26</b>	

(a) Each

**E7.5.10 Special Access (a.k.a. BellSouth SPA) Surcharge**

- A. Rates
  - 1. Per Voice Grade Equivalent

<b>25.00</b>	<b>\$25</b>
--------------	-------------

(a) Each

**E7.5.11 Reserved For Future Use**

**E7.5.12 Reserved For Future Use**

**E7.5.13 Transfer of Service**

- A. Service Rearrangements
  - 1. Special Access (a.k.a. BellSouth SPA) Circuits

<b>Nonrecurring</b>	<b>USOC</b>	
<b>Charge</b>	<b>NRBPA</b>	<b>(R)</b>
<b>\$50.00</b>	<b>NRBPC</b>	<b>(R)</b>
<b>6.00</b>		

(a) Per Billing Account Number

(b) Per circuit

**E7.5.14 (DELETED)**

BELLSOUTH  
TELECOMMUNICATIONS  
TENNESSEE

ACCESS SERVICES TARIFF

Fourth Revised Page 52.0.1  
Cancels Third Revised Page 52.0.1

ISSUED: November 30, 2001

EFFECTIVE: December 31, 2001

BY: Joelle Phillips, President - Tennessee  
Nashville, Tennessee

## **E7. SPECIAL ACCESS (A.K.A. BELLSOUTH SPA) SERVICE**

### **E7.5 Rates And Charges (Cont'd)**

**E7.5.14 (DELETED) (Cont'd)**

(D)

BELLSOUTH  
TELECOMMUNICATIONS  
TENNESSEE

ACCESS SERVICES TARIFF

Tenth Revised Page 52.0.2  
Cancels Ninth Revised Page 52.0.2

ISSUED: June 9, 2021  
BY: Joelle Phillips, President - Tennessee  
Nashville, Tennessee

EFFECTIVE: June 30, 2021

**E7. SPECIAL ACCESS (A.K.A. BELLSOUTH SPA) SERVICE**

**E7.5 Rates And Charges (Cont'd)**

**E7.5.15 Derived Data Channel (a.k.a. BellSouth SPA Derived Data Channel)<sup>3</sup> Service**

(C)

**A. Local Channel**

1. Derived Data Channel (a.k.a. BellSouth SPA Derived Data Channel)

	Nonrecurring Charge	Month to Month <sup>2</sup>	24 to 42 Months <sup>2</sup>	43 to 60 Months <sup>2</sup>	USOC
(a) Per channel at 2.4 Kbps	\$470.00	\$17.00	\$13.50	\$11.00	DAXPC
2. DS0-B Interface					
(a) Per group of twenty channels at 2.4 Kbps each	350.00	70.00	65.00	62.00	DAXP1

**B. Interoffice Channel**

1. Per group of twenty channels at 2.4 Kbps each

(a) Fixed	95.00	25.00	23.00	22.00	DAXPF
(b) Per mile	-	2.05	1.90	1.75	DAXPM

**E7.5.16 FlexServ Service (a.k.a. BellSouth SPA Customer Reconfiguration)**

**A. Basic FlexServ service (a.k.a. BellSouth SPA Customer Reconfiguration)**

1. DS0 Channel Connections

	Nonrecurring Charge	Month To Month <sup>1,2</sup>	24 to 48 Months <sup>1,2</sup>	49 to 72 Months <sup>1,2</sup>	73 to 96 Months <sup>1,2</sup>	USOC
(a) Voice Grade Type, per DS0 channel	\$35.00	\$14.90	\$13.70	\$12.70	\$11.90	DSLVA
(b) Digital Type, per DS0 channel	35.00	7.15	6.60	6.44	5.72	DSLDA
2. DS1 Channel Connections						
(a) DS0 Switching, per DS1 channel	125.00	104.50	95.70	89.10	83.60	DSL1A
(b) DS1 Switching, per DS1 channel	125.00	60.50	55.00	51.70	48.40	DSL1B
(b) Surveillance – DS1 Level, per DS1 channel	125.00	60.50	55.00	51.70	48.40	DSL1S
3. DS3 Channel Connections						
(a) Surveillance - DS1 Level, per DS3 channel	125.00	375.00	345.00	320.00	300.00	DSL3S
(b) Surveillance - DS3 Level, per DS3 channel	125.00	150.00	138.00	128.00	120.00	DSL3T

**B. FlexServ service (a.k.a. BellSouth SPA Customer Reconfiguration) Options**

1. Multipoint Bridging

(a) Voice Grade Connections, per bridging leg	20.00	5.00	4.50	4.40	4.30	FSSF9
(b) Multipoint Junction Unit, per 2.4, 4.8, 9.6 or 56 Kbps channel (must purchase in units of 5)	15.00	6.00	5.25	5.00	4.75	FSSFJ
(c) Multipoint Junction Unit, per 19.2 Kbps channel (must purchase in units of 5)	15.00	9.45	8.90	8.40	7.90	FSSF9

**Note 1:** Effective December 16, 2013, Customers may not establish new term plans greater than 36 months for FlexServ® Service and term plans may not be renewed for a term greater than 36 months.

**Note 2:** Effective March 28, 2019, Customers may not convert, renew or establish CSPPs for Derived Data Channel Service and FlexServ Service.

**Note 3:** Effective June 30, 2021, this Service will no longer be available for purchase by new or existing customers. In addition, requests to move, add, change, or renew existing service arrangements will not be accepted. Following the expiration of a customer's existing term agreement, service will be provided on a month-to-month basis at the applicable Monthly rates until the service is discontinued. The Company currently plans to discontinue this service on or after June 30, 2024.

(N)

(N)

BELLSOUTH  
 TELECOMMUNICATIONS  
 TENNESSEE  
 ISSUED: March 7, 2019  
 BY: Joelle Phillips, President - Tennessee  
 Nashville, Tennessee

ACCESS SERVICES TARIFF

Eighth Revised Page 52.0.3  
 Cancels Seventh Revised Page 52.0.3

EFFECTIVE: March 28, 2019

**E7. SPECIAL ACCESS (A.K.A. BELLSOUTH SPA) SERVICE**

**E7.5 Rates And Charges (Cont'd)**

**E7.5.16 FlexServ Service (a.k.a. BellSouth SPA Customer Reconfiguration) (Cont'd)**

**B. FlexServ Service (a.k.a. BellSouth SPA Customer Reconfiguration) Options (Cont'd)**

2. Subrate Reconfiguration Capability

		Nonrecurring Charge			USOC		
		\$45.00			DSL5B		
		Month	24 to	49 to	73 to		
		To	48	72	96		
		Nonrecurring	Month	Months <sup>1,3</sup>	Months <sup>1,3</sup>	Months <sup>1,3</sup>	USOC
		Charge	Month	Months <sup>1,3</sup>	Months <sup>1,3</sup>	Months <sup>1,3</sup>	(N)
(a)	Per DS0 equipped (DS0B)						
(b)	9.6 Kbps, per DS0A requires 5	\$5.00	\$8.75	\$8.15	\$7.60	\$7.20	DSL59
(c)	4.8 Kbps, per DS0A requires 10	5.00	7.40	6.80	6.30	5.95	DSL54
(d)	2.4 Kbps, per DS0A requires 20	5.00	7.00	6.45	5.95	5.60	DSL52
3.	Additional Concurrent User Access						
(a)	Per Additional User Access	125.00	68.00	60.00	57.00	54.00	FSSFU
4.	Additional User Identification Codes						
(a)	Per Additional Code			Nonrecurring Charge		\$3.00	USOC
5.	Additional Customer Training						FSSFA
(a)	Per eight hour day of training after initial installation				450.00		FSSFT
6.	Reconfiguration by Company Personnel						
(a)	Request for Company to perform reconfiguration activity				25.00		FSSRA
7.	<b>(DELETED)</b>						

**E7.5.17 SMARTPath Service (a.k.a. BellSouth SPA Shared Ring)**

**A. SMARTPath service (a.k.a. BellSouth SPA Shared Ring) Area Connection**

1. 1.544 Mbps

		Nonrecurring Charge		Month	Plan A	Plan B	USOC
		First	Additional	to	24 to 48	49 to 72	
		Month	Month	Month	Months <sup>2</sup>	Months <sup>2</sup>	
(a)	Per SMARTPath service (a.k.a. BellSouth Shared Ring) Area Connection	\$435.00	\$140.00	\$300.00	\$210.00	\$200.00	TMJ1A

**B. SMARTPath service (a.k.a. BellSouth SPA Shared Ring) Area Junction**

1. 1.544 Mbps

(a)	Per Customer Designated Premises	435.00	140.00	125.00	80.00	65.00	TMJ1B
(b)	Per Serving Wire Center Connection	435.00	140.00	50.00	25.00	20.00	TMJ1C

**C. Virtual Collocation Cross-Connect to SMARTPath service (a.k.a. BellSouth SPA Shared Ring)**

1. Area Connection and Area Junction

		Nonrecurring Charge		Monthly	USOC
		First	Additional	Rate	
(a)	Per DS1 Cross-Connect	\$155.00	\$14.00	\$7.50	CNC1X

**Note 1:** Effective November 9th, 2013, customers may not establish new term plans greater than 36 months for FlexServ Service and term plans may not be renewed for a term greater than 36 months.

**Note 2:** Effective November 9th, 2013, customers may not establish new term plans greater than 36 months for SMARTPath Service and term plans may not be renewed for a term greater than 36 months.

**Note 3:** Effective March 28, 2019 Customers may not: (1) Convert, renew or establish CSPPs for FlexServ Service and (2) Convert or renew CSPPs for SMARTPath Service. (N)



BELLSOUTH  
TELECOMMUNICATIONS  
TENNESSEE

ACCESS SERVICES TARIFF

Third Revised Page 52.0.4  
Cancels Second Revised Page 52.0.4

ISSUED: November 10, 2021

EFFECTIVE: December 1, 2021

BY: Joelle Phillips, President - Tennessee  
Nashville, Tennessee

## E7. SPECIAL ACCESS (A.K.A.BELLSOUTH SPA) SERVICE

### E7.5 Rates and Charges (Cont'd)

#### E7.5.18 SMARTRing<sup>®</sup> service (a.k.a BellSouth Dedicated Ring)

(C)

##### A. Self-healing Multi-nodal Alternate Route Topology Ring - Month-to-Month

##### 1. Local Channel (All capacities except OC-1)

	Month-to-Month	Nonrecurring Charge	USOC
(a) Per Local Channel	-	\$405.00	1HVXX
(b) Per Quarter Air Mile	\$95.00	-	1HVXX
2. Alternate Central Office (All capacities except OC-1)			
(a) Per Alternate C.O. Channel	-	555.00	1HAXX
(b) Per Quarter Air Mile	1,500.00	-	1HAXX
3. Interoffice Channel (All capacities except OC-1)			
(a) Per Channel, <i>except OC-192 and OC-192+</i>	-	245.00	1HXFX
(b) Fixed, OC-3 Capacity	50.00	-	1HXFX
(c) Fixed, OC-3+, OC-12, OC-48 or OC-48+ Capacity	175.00	-	1HXFX
(d) Fixed, OC-192 or OC-192+ Capacity	600.00	300.00	1HXFX
(e) Per Quarter Air Mile, OC-3 Capacity	45.00	-	1HXFX
(f) Per Quarter Air Mile, OC-3+, OC-12, OC-48 or OC-48+ Capacity	55.00	-	1HXFX
(g) Per Quarter Air Mile, OC-192 or OC-192+ Capacity	55.00	-	1HXFX
4. Internodal Channel (All capacities except OC-1)			
(a) Per Internodal Channel, Same Wire Center Area, Per Quarter Air Mile	3,000.00	430.00	1HNXX
(b) Per Internodal Channel, Same Office Park/Campus Environment in Contiguous Serving Wire Center Areas, Per Quarter Air Mile	3,500.00	430.00	1HNZX
5. Customer Node (Per Customer Node)			
(a) OC-1 Capacity	800.00	425.00	SHNC4
(b) OC-3 Capacity	2,200.00	575.00	SHNC3
(c) OC-3+ Capacity	3,000.00	575.00	SHNN5
(d) OC-12 Capacity	3,400.00	575.00	SHNC1
(e) OC-48 Capacity	5,800.00	575.00	SHNN8
(f) OC-48+ Capacity	6,500.00	575.00	SHNN9
(g) OC-192 Capacity	25,000.00	640.00	SHNN6
(h) OC-192+ Capacity	25,000.00	640.00	SHNN2

**Note 1:** Effective on or after December 1, 2021, neither new nor existing customers will be permitted to purchase new SMARTRing Service (Service). In addition, (A) Service Payment Plans greater than 12-months in length will no longer be available; and (B) requests to move, add, change, upgrade, or downgrade existing service arrangements will not be accepted, with the following exceptions: (1) existing customers will be permitted to modify their existing Service and will be able to add new circuits to their existing Service, but will not be permitted to add new nodes in any locations; and (2) any such new circuits will be subject to the customer's existing term payment plan or term agreement for the Service to which they are added. Following the expiration of a customer's existing term agreement, Service will be provided on a month-to-month basis at the applicable Month-to-Month rates until the Service is discontinued.

(N)

Effective November 30, 2023, unless specified to the contrary in their existing Service agreements, existing customers may not renew Term Payment Plans or term agreements for Service. In addition, no move, add, or change orders of any type will be accepted.

(N)

BELLSOUTH  
TELECOMMUNICATIONS  
TENNESSEE

ACCESS SERVICES TARIFF

Fourth Revised Page 52.0.4.1  
Cancels Third Revised Page 52.0.4.1

ISSUED: November 10, 2021

EFFECTIVE: December 1, 2021

BY: Joelle Phillips, President - Tennessee  
Nashville, Tennessee

## E7. SPECIAL ACCESS (A.K.A. BELLSOUTH SPA) SERVICE

### E7.5 Rates and Charges (Cont'd)

E7.5.18 SMARTRing<sup>2</sup> service (a.k.a BellSouth Dedicated Ring) (Cont'd)

(C)

A. Self-healing Multi-nodal Alternate Route Topology Ring - Month-to-Month (Cont'd)

6. Customer Channel Interface (Per Customer Node)

	Month-to-Month	Nonrecurring Charge	USOC
(a) Per DS1	\$35.00	\$235.00	SHNBB
(b) Per DS3	170.00	105.00	SHNZT
(c) Per STS-1	220.00	105.00	SHN13
(d) Per OC-1	100.00	115.00	SHN1C
(e) Per OC-3, 2-Fiber	240.00	110.00	SHN1D
(f) Per OC-3, 4-Fiber	475.00	110.00	SHN15
(g) Per OC-12, 2-Fiber	715.00	115.00	SHN1F
(h) Per OC-12, 4-Fiber	1,430.00	115.00	SHN19
(i) Per OC-48, 2-Fiber	1,600.00	640.00	SHN1A
(j) Per OC-48, 4-Fiber	3,200.00	640.00	SHN1B
(k) Per 1000 Mbps	740.00	540.00	SHN1K
(l) Per 100 Mbps (1 STS-1) BellSouth Metro Ethernet <sup>1</sup> Backbone	500.00	800.00	SHN1J
(m) Per 100 Mbps (3 STS-1) BellSouth Metro Ethernet <sup>1</sup> Backbone	540.00	800.00	SHN33
(n) Per 1000 Mbps BellSouth Metro Ethernet <sup>1</sup> Backbone	740.00	850.00	SHN34
(o) Per Fractional 1000 Mbps Metro Ethernet <sup>1</sup> Backbone			
- 150 Mbps (3 STS-1)	560.00	850.00	SHN35
- 300 Mbps (6 STS-1)	600.00	850.00	SHN36
- 450 Mbps (9 STS-1)	640.00	850.00	SHN37
- 600 Mbps (12 STS-1)	700.00	850.00	SHN38
7. Central Office Node (Per Central Office Node)			
(a) OC-1 Capacity	600.00	420.00	SHNH4
(b) OC-3 Capacity	1,400.00	575.00	SHNH3
(c) OC-3+ Capacity	2,500.00	575.00	SHNH5
(d) OC-12 Capacity	2,600.00	575.00	SHNH1
(e) OC-48 Capacity	5,400.00	575.00	SHNH8
(f) OC-48+ Capacity	6,100.00	575.00	SHNH9
(g) OC-192 Capacity	25,000.00	640.00	SHNH7
(h) OC-192+ Capacity	25,000.00	640.00	SHNH6
(i) OC-3 Shared Node Interconnection	980.00	550.00	SHNHE
(j) OC-12 Shared Node Interconnection	1,820.00	550.00	SHNHE
(k) OC-48 Shared Node Interconnection	3,400.00	550.00	SHNHE
(l) OC-48+ Shared Node Interconnection	3,840.00	550.00	SHNHE

**Note 1:** Effective on or after August 22, 2021, this Service will no longer be available for purchase by new or existing customers. In addition, requests to move, add, change, or renew existing service arrangements will not be accepted. Following the expiration of a customer's existing term agreement, service will be provided on a month-to-month basis at the applicable Monthly rates until the service is discontinued. The Company currently plans to discontinue this service on or after March 31, 2023.

**Note 2:** Effective on or after December 1, 2021, neither new nor existing customers will be permitted to purchase new SMARTRing Service (Service). In addition, (A) Service Payment Plans greater than 12-months in length will no longer be available; and (B) requests to move, add, change, upgrade, or downgrade existing service arrangements will not be accepted, with the following exceptions: (1) existing customers will be permitted to modify their existing Service and will be able to add new circuits to their existing Service, but will not be permitted to add new nodes in any locations; and (2) any such new circuits will be subject to the customer's existing term payment plan or term agreement for the Service to which they are added. Following the expiration of a customer's existing term agreement, Service will be provided on a month-to-month basis at the applicable Month-to-Month rates until the Service is discontinued.

(N)

Effective November 30, 2023, unless specified to the contrary in their existing Service agreements, existing customers may not renew Term Payment Plans or term agreements for Service. In addition, no move, add, or change orders of any type will be accepted.

(N)

BELLSOUTH  
TELECOMMUNICATIONS  
TENNESSEE

ACCESS SERVICES TARIFF

Sixth Revised Page 52.0.5  
Cancels Fifth Revised Page 52.0.5

ISSUED: November 10, 2021

EFFECTIVE: December 1, 2021

BY: Joelle Phillips, President - Tennessee  
Nashville, Tennessee

## E7. SPECIAL ACCESS (A.K.A. BELLSOUTH SPA) SERVICE

### E7.5 Rates and Charges (Cont'd)

E7.5.18 SMARTRing<sup>2</sup> service (a.k.a BellSouth Dedicated Ring) (Cont'd)

(C)

A. Self-healing Multi-nodal Alternate Route Topology Ring - Month-to-Month (Cont'd)

8. Central Office Channel Interface (Per Central Office Node)

	Month-to-Month	Nonrecurring Charge	USOC
(a) Per DS1	\$35.00	\$98.00	SHNCB
(b) Per DS3	115.00	150.00	SHNYT
(c) Per STS-1	150.00	155.00	SHNO2
(d) Per OC-1	100.00	170.00	SHNCC
(e) Per OC-3, 2-Fiber	240.00	99.00	SHNCD
(f) Per OC-3, 4-Fiber	425.00	99.00	SHNO4
(g) Per OC-12, 2-Fiber	640.00	99.00	SHNCF
(h) Per OC-12, 4-Fiber	1,280.00	99.00	SHNC9
(i) Per OC-48, 2-Fiber	1,600.00	640.00	SHNCJ
(j) Per OC-48, 4-Fiber	3,200.00	640.00	SHNCK
(k) Per 28 DS1 Channel System - DS3	650.00	130.00	SHNW8
(l) Per 28 DS1 Channel System - STS-1	750.00	130.00	SHNCS
(m) Per DS1 on 28 DS1 Channel System - DS3	12.00	125.00	SHNCA
(n) Per DS1 on 28 DS1 Channel System - STS-1	40.00	81.00	SHNCG
(o) Per 1000 Mbps	740.00	400.00	SHNCW
(p) Per 100 Mbps (1 STS-1) BellSouth Metro Ethernet <sup>1</sup> Backbone	500.00	800.00	SHNOJ
(q) Per 100 Mbps (3 STS-1) BellSouth Metro Ethernet <sup>1</sup> Backbone	540.00	800.00	SHNCX
(r) Per 1000 Mbps BellSouth Metro Ethernet <sup>1</sup> Backbone	740.00	850.00	SHNC5
(s) Per Fractional 1000 Mbps Metro Ethernet <sup>1</sup> Backbone			
- 150 Mbps (3 STS-1)	560.00	850.00	SHND5
- 300 Mbps (6 STS-1)	600.00	850.00	SHND6
- 450 Mbps (9 STS-1)	640.00	850.00	SHND7
- 600 Mbps (12 STS-1)	700.00	850.00	SHND8

**Note 1:** Effective on or after August 22, 2021, this Service will no longer be available for purchase by new or existing customers. In addition, requests to move, add, change, or renew existing service arrangements will not be accepted. Following the expiration of a customer's existing term agreement, service will be provided on a month-to-month basis at the applicable Monthly rates until the service is discontinued. The Company currently plans to discontinue this service on or after March 31, 2023.

**Note 2:** Effective on or after December 1, 2021, neither new nor existing customers will be permitted to purchase new SMARTRing Service (Service). In addition, (A) Service Payment Plans greater than 12-months in length will no longer be available; and (B) requests to move, add, change, upgrade, or downgrade existing service arrangements will not be accepted, with the following exceptions: (1) existing customers will be permitted to modify their existing Service and will be able to add new circuits to their existing Service, but will not be permitted to add new nodes in any locations; and (2) any such new circuits will be subject to the customer's existing term payment plan or term agreement for the Service to which they are added. Following the expiration of a customer's existing term agreement, Service will be provided on a month-to-month basis at the applicable Month-to-Month rates until the Service is discontinued.

(N)

Effective November 30, 2023, unless specified to the contrary in their existing Service agreements, existing customers may not renew Term Payment Plans or term agreements for Service. In addition, no move, add, or change orders of any type will be accepted.

(N)

BELLSOUTH  
TELECOMMUNICATIONS  
TENNESSEE

ACCESS SERVICES TARIFF

Third Revised Page 52.0.5.1  
Cancels Second Revised Page 52.0.5.1

ISSUED: November 10, 2021  
BY: Joelle Phillips, President - Tennessee  
Nashville, Tennessee

EFFECTIVE: December 1, 2021

**E7. SPECIAL ACCESS (A.K.A. BELLSOUTH SPA) SERVICE**

**E7.5 Rates and Charges (Cont'd)**

**E7.5.18 SMARTRing<sup>2</sup> service (a.k.a BellSouth Dedicated Ring) (Cont'd)**

**B. Self-healing Multi-nodal Alternate Route Topology Ring - Transport Payment Plan**

1. Local Channel (All capacities except OC-1)

		Per Month Rates			
		A	B	C	
		12-36	37-60	61-96	
		Months <sup>2</sup>	Months <sup>1, 2</sup>	Months <sup>1, 2</sup>	
					USOC
2.	(a) Per Quarter Air Mile Alternate Central Office (All capacities except OC-1)	\$85.00	\$75.00	\$70.00	1HVXX
3.	(a) Per Quarter Air Mile Interoffice Channel (All capacities except OC-1)	400.00	250.00	200.00	1HAXX
	(a) Fixed, OC-3 Capacity	40.00	35.00	30.00	1HXFX
	(b) Fixed, OC-3+, OC-12, OC-48 or OC-48+ Capacity	155.00	140.00	130.00	1HXFX
	(c) Fixed, OC-192 or OC-192+ Capacity	450.00	400.00	380.00	1HXFX
	(d) Per Quarter Air Mile, OC-3 Capacity	35.00	25.00	20.00	1HXFX
	(e) Per Quarter Air Mile, OC-3+, OC-12, OC-48 or OC-48+ Capacity	40.00	33.00	25.00	1HXFX
	(f) Per Quarter Air Mile, OC-192 or OC-192+ Capacity	40.00	33.00	25.00	1HXFX
4.	(a) Per Internodal Channel, Same Wire Center Area, Per Quarter Air Mile Internodal Channel (All capacities except OC-1)	690.00	415.00	345.00	1HNXX
	(b) Per Internodal Channel, Same Office Park/Campus Environment in Contiguous Serving Wire Center Areas, Per Quarter Air Mile	780.00	465.00	390.00	1HNZX
5.	(a) OC-1 Capacity Customer Node (Per Customer Node)	400.00	350.00	300.00	SHNC4
	(b) OC-3 Capacity	1,100.00	1,000.00	900.00	SHNC3
	(c) OC-3+ Capacity	2,050.00	1,750.00	1,500.00	SHNN5
	(d) OC-12 Capacity	2,200.00	2,000.00	1,750.00	SHNC1
	(e) OC-48 Capacity	4,900.00	4,500.00	3,900.00	SHNN8
	(f) OC-48+ Capacity	4,900.00	4,500.00	3,900.00	SHNN9
	(g) OC-192 Capacity	9,375.00	8,250.00	7,300.00	SHNN6
	(h) OC-192+ Capacity	9,375.00	8,250.00	7,300.00	SHNN2

**Note 1:** All term plans for SMARTRing<sup>®</sup> Service which are established, renewed or extended after December 16, 2013, for term lengths which are scheduled to expire at any time after February 1, 2019, will instead expire on February 1, 2019. All such services existing on or after February 1, 2019, will be provided on a month-to-month basis at the applicable, then current month-to-month rates.

**Note 2:** Effective on or after December 1, 2021, neither new nor existing customers will be permitted to purchase new SMARTRing Service (Service). In addition, (A) Service Payment Plans greater than 12-months in length will no longer be available; and (B) requests to move, add, change, upgrade, or downgrade existing service arrangements will not be accepted, with the following exceptions: (1) existing customers will be permitted to modify their existing Service and will be able to add new circuits to their existing Service, but will not be permitted to add new nodes in any locations; and (2) any such new circuits will be subject to the customer's existing term payment plan or term agreement for the Service to which they are added. Following the expiration of a customer's existing term agreement, Service will be provided on a month-to-month basis at the applicable Month-to-Month rates until the Service is discontinued.

Effective November 30, 2023, unless specified to the contrary in their existing Service agreements, existing customers may not renew Term Payment Plans or term agreements for Service. In addition, no move, add, or change orders of any type will be accepted.

BELLSOUTH  
TELECOMMUNICATIONS  
TENNESSEE

ACCESS SERVICES TARIFF

Eighth Revised Page 52.0.6  
Cancels Seventh Revised Page 52.0.6

ISSUED: November 10, 2021

EFFECTIVE: December 1, 2021

BY: Joelle Phillips, President - Tennessee  
Nashville, Tennessee

## E7. SPECIAL ACCESS (A.K.A. BELLSOUTH SPA) SERVICE

### E7.5 Rates and Charges (Cont'd)

#### E7.5.18 SMARTRing<sup>3</sup> service (a.k.a BellSouth Dedicated Ring) (Cont'd)

##### B. Self-healing Multi-nodal Alternate Route Topology Ring - Transport Payment Plan (Cont'd)

##### 6. Customer Channel Interface (Per Customer Node)

		Per Month Rates			
		A	B	C	
		12-36	37-60	61-96	
		Months <sup>3</sup>	Months <sup>1, 3</sup>	Months <sup>1, 3</sup>	USOC
(a)	Per DS1	\$34.00	\$27.00	\$21.00	SHNBB
(b)	Per DS3	135.00	130.00	125.00	SHNZT
(c)	Per STS-1	170.00	150.00	140.00	SHN13
(d)	Per OC-1	90.00	80.00	75.00	SHN1C
(e)	Per OC-3, 2-Fiber	190.00	175.00	160.00	SHN1D
(f)	Per OC-3, 4-Fiber	380.00	350.00	320.00	SHN15
(g)	Per OC-12, 2-Fiber	570.00	525.00	480.00	SHN1F
(h)	Per OC-12, 4-Fiber	1,140.00	1,050.00	960.00	SHN19
(i)	Per OC-48, 2-Fiber	1,325.00	1,215.00	1,050.00	SHN1A
(j)	Per OC-48, 4-Fiber	2,650.00	2,430.00	2,100.00	SHN1B
(k)	Per 1000 Mbps	520.00	475.00	425.00	SHN1K
(l)	Per 100 Mbps (1 STS-1) BellSouth Metro Ethernet <sup>2</sup> Backbone	175.00	155.00	140.00	SHN1J
(m)	Per 100 Mbps (3 STS-1) BellSouth Metro Ethernet <sup>2</sup> Backbone	210.00	190.00	170.00	SHN33
(n)	Per 1000 Mbps BellSouth Metro Ethernet <sup>2</sup> Backbone	520.00	475.00	425.00	SHN34
(o)	Per Fractional 1000 Mbps Metro Ethernet <sup>2</sup> Backbone				
	- 150 Mbps (3 STS-1)	230.00	210.00	190.00	SHN35
	- 300 Mbps (6 STS-1)	300.00	280.00	260.00	SHN36
	- 450 Mbps (9 STS-1)	340.00	310.00	290.00	SHN37
	- 600 Mbps (12 STS-1)	380.00	340.00	320.00	SHN38

**Note 1:** All term plans for SMARTRing<sup>®</sup> Service which are established, renewed or extended after December 16, 2013, for term lengths which are scheduled to expire at any time after February 1, 2019, will instead expire on February 1, 2019. All such services existing on or after February 1, 2019, will be provided on a month-to-month basis at the applicable, then current month-to-month rates.

**Note 2:** Effective on or after August 22, 2021, this Service will no longer be available for purchase by new or existing customers. In addition, requests to move, add, change, or renew existing service arrangements will not be accepted. Following the expiration of a customer's existing term agreement, service will be provided on a month-to-month basis at the applicable Monthly rates until the service is discontinued. The Company currently plans to discontinue this service on or after March 31, 2023.

**Note 3:** Effective on or after December 1, 2021, neither new nor existing customers will be permitted to purchase new SMARTRing Service (Service). In addition, (A) Service Payment Plans greater than 12-months in length will no longer be available; and (B) requests to move, add, change, upgrade, or downgrade existing service arrangements will not be accepted, with the following exceptions: (1) existing customers will be permitted to modify their existing Service and will be able to add new circuits to their existing Service, but will not be permitted to add new nodes in any locations; and (2) any such new circuits will be subject to the customer's existing term payment plan or term agreement for the Service to which they are added. Following the expiration of a customer's existing term agreement, Service will be provided on a month-to-month basis at the applicable Month-to-Month rates until the Service is discontinued.

Effective November 30, 2023, unless specified to the contrary in their existing Service agreements, existing customers may not renew Term Payment Plans or term agreements for Service. In addition, no move, add, or change orders of any type will be accepted.

BELLSOUTH  
TELECOMMUNICATIONS  
TENNESSEE

ACCESS SERVICES TARIFF

Fifth Revised Page 52.0.6.1  
Cancels Fourth Revised Page 52.0.6.1

ISSUED: November 10, 2021

EFFECTIVE: December 1, 2021

BY: Joelle Phillips, President - Tennessee  
Nashville, Tennessee

**E7. SPECIAL ACCESS (A.K.A. BELLSOUTH SPA) SERVICE**

**E7.5 Rates and Charges (Cont'd)**

**E7.5.18 SMARTRing<sup>3</sup> service (a.k.a BellSouth Dedicated Ring) (Cont'd)**

- B. Self-healing Multi-nodal Alternate Route Topology Ring - Transport Payment Plan (Cont'd)
  - 7. Central Office Node (Per Central Office Node)

		Per Month Rates			
		A	B	C	
		12-36	37-60	61-96	
		Months <sup>3</sup>	Months <sup>1,3</sup>	Months <sup>1,3</sup>	USOC
(a)	OC-1 Capacity	\$400.00	\$350.00	\$300.00	SHNH4
(b)	OC-3 Capacity	1,100.00	1,000.00	900.00	SHNH3
(c)	OC-3+ Capacity	2,050.00	1,750.00	1,500.00	SHNH5
(d)	OC-12 Capacity	2,200.00	2,000.00	1,750.00	SHNH1
(e)	OC-48 Capacity	4,900.00	4,500.00	3,900.00	SHNH8
(f)	OC-48+ Capacity	4,900.00	4,500.00	3,900.00	SHNH9
(g)	OC-192 Capacity	9,375.00	8,250.00	7,300.00	SHNH7
(h)	OC-192+ Capacity	9,375.00	8,250.00	7,300.00	SHNH6
(i)	OC-3 Shared Node Interconnection	690.00	630.00	570.00	SHNHE
(j)	OC-12 Shared Node Interconnection	1,390.00	1,260.00	1,100.00	SHNHE
(k)	OC-48 Shared Node Interconnection	2,880.00	2,840.00	2,460.00	SHNHE
(l)	OC-48+ Shared Node Interconnection	2,880.00	2,840.00	2,460.00	SHNHE
8.	Central Office Channel Interface (Per Central Office Node)				
(a)	Per DS1	30.00	25.00	20.00	SHNCB
(b)	Per DS3	85.00	80.00	75.00	SHNYT
(c)	Per STS-1	105.00	100.00	90.00	SHNO2
(d)	Per OC-1	90.00	80.00	75.00	SHNCC
(e)	Per OC-3, 2-Fiber	190.00	175.00	160.00	SHNCD
(f)	Per OC-3, 4-Fiber	330.00	300.00	270.00	SHNO4
(g)	Per OC-12, 2-Fiber	495.00	450.00	405.00	SHNCF
(h)	Per OC-12, 4-Fiber	990.00	900.00	810.00	SHNC9
(i)	Per OC-48, 2-Fiber	1,325.00	1,215.00	1,050.00	SHNCJ
(j)	Per OC-48, 4-Fiber	2,650.00	2,430.00	2,100.00	SHNCK
(k)	Per 28 DS1 Channel System - DS3	550.00	500.00	450.00	SHNW8
(l)	Per 28 DS1 Channel System - STS-1	650.00	600.00	575.00	SHNCS
(m)	Per DS1 on 28 DS1 Channel System - DS3	12.00	9.00	7.00	SHNCA
(n)	Per DS1 on 28 DS1 Channel System - STS-1	35.00	30.00	25.00	SHNCG
(o)	Per 1000 Mbps	520.00	475.00	425.00	SHNCW
(p)	Per 100 Mbps (1 STS-1) BellSouth Metro Ethernet <sup>2</sup> Backbone	175.00	155.00	140.00	SHNOJ
(q)	Per 100 Mbps (3 STS-1) BellSouth Metro Ethernet <sup>2</sup> Backbone	210.00	190.00	170.00	SHNCX
(r)	Per 1000 Mbps BellSouth Metro Ethernet <sup>2</sup> Backbone	520.00	475.00	425.00	SHNC5
(s)	Per Fractional 1000 Mbps Metro Ethernet <sup>2</sup> Backbone				
	- 150 Mbps (3 STS-1)	230.00	210.00	190.00	SHND5
	- 300 Mbps (6 STS-1)	300.00	280.00	260.00	SHND6
	- 450 Mbps (9 STS-1)	340.00	310.00	290.00	SHND7
	- 600 Mbps (12 STS-1)	380.00	340.00	320.00	SHND8

C. Self-healing Multi-nodal Alternate Route Topology Ring

- 1. Channel Interface Reallocation

(a)	Per Node, Per Occurrence	Nonrecurring Charge	USOC
		\$245.00	SHRBC

**Note 1:** All term plans for SMARTRing<sup>®</sup> Service which are established, renewed or extended after December 16, 2013, for term lengths which are scheduled to expire at any time after February 1, 2019, will instead expire on February 1, 2019. All such services existing on or after February 1, 2019, will be provided on a month-to-month basis at the applicable, then current month-to-month rates.

**Note 2:** Effective on or after August 22, 2021, this Service will no longer be available for purchase by new or existing customers. In addition, requests to move, add, change, or renew existing service arrangements will not be accepted. Following the expiration of a customer's existing term agreement, service will be provided on a month-to-month basis at the applicable Monthly rates until the service is discontinued. The Company currently plans to discontinue this service on or after March 31, 2023.

**Note 3:** Effective on or after December 1, 2021, neither new nor existing customers will be permitted to purchase new SMARTRing Service (Service). In addition, (A) Service Payment Plans greater than 12-months in length will no longer be available; and (B) requests to move, add, change, upgrade, or downgrade existing service arrangements will not be accepted, with the following exceptions: (1) existing customers will be permitted to modify their existing Service and will be able to add new circuits to their existing Service, but will not be permitted to add new nodes in any locations; and (2) any such new circuits will be subject to the customer's existing term payment plan or term agreement for the Service to which they are added. Following the expiration of a customer's existing term agreement, Service will be provided on a month-to-month basis at the applicable Month-to-Month rates until the Service is discontinued.

Effective November 30, 2023, unless specified to the contrary in their existing Service agreements, existing customers may not renew Term Payment Plans or term agreements for Service. In addition, no move, add, or change orders of any type will be accepted.

BELLSOUTH  
TELECOMMUNICATIONS  
TENNESSEE

ACCESS SERVICES TARIFF

Fourth Revised Page 52.0.7  
Cancels Third Revised Page 52.0.7

ISSUED: October 10, 2014  
BY: Joelle Phillips, President - Tennessee  
Nashville, Tennessee

EFFECTIVE: October 31, 2014

## **E7. SPECIAL ACCESS (A.K.A. BELLSOUTH SPA) SERVICE**

### **E7.5 Rates and Charges (Cont'd)**

#### **E7.5.19 Reserved for Future Use**

(T)

(D)

(D)

BELLSOUTH  
TELECOMMUNICATIONS  
TENNESSEE

ACCESS SERVICES TARIFF

Fourth Revised Page 52.0.8  
Cancels Third Revised Page 52.0.8

ISSUED: May 25, 2023

EFFECTIVE: June 15, 2023

BY: Joelle Phillips, President - Tennessee  
Nashville, Tennessee

**E7. SPECIAL ACCESS (A.K.A. BELLSOUTH SPA) SERVICE**

**E7.5 Rates and Charges (Cont'd)**

**E7.5.20 Reserved For Future Use**

**E7.5.21 Reserved For Future Use**

**E7.5.22 BellSouth Metro Ethernet Service<sup>1</sup>**

**A. Rates and charges for month-to-month service**

**1. Basic BellSouth Metro Ethernet Service Arrangements**

**(a) 2 Mbps Basic Connection**

- Per Connection

Nonrecurring Charge	Month to Month	USOC
\$ 950.00	\$ 668.25	MTEBO

**(b) 4 Mbps Basic Connection**

- Per Connection

950.00	695.25	MTEB1
--------	--------	-------

**(c) 8 Mbps Basic Connection**

- Per Connection

950.00	810.00	MTEB2
--------	--------	-------

**(d) 10 Mbps Basic Connection**

- Per Connection

900.00	918.00	MTEBA
--------	--------	-------

**(e) 100 Mbps Basic Connection**

- Per Connection

900.00	1,768.50	MTEBB
--------	----------	-------

**(f) 1 Gbps Basic Connection**

- Per Connection

1,000.00	3,847.50	MTEBC
----------	----------	-------

**2. Premium BellSouth Metro Ethernet Service Arrangements**

**(a) 2 Mbps Premium Connection**

- Per Connection, Fixed Mode

950.00	739.80	MTEPO
--------	--------	-------

**(b) 4 Mbps Premium Connection**

- Per Connection, Fixed Mode

950.00	777.60	MTEP1
--------	--------	-------

**(c) 8 Mbps Premium Connection**

- Per Connection, Fixed Mode

950.00	896.40	MTEP2
--------	--------	-------

**(d) 10 Mbps Premium Connection**

- Per Connection, Fixed Mode

900.00	1,220.40	MTEP3
--------	----------	-------

- Per Connection, Burst Mode

900.00	1,529.55	MTEE3
--------	----------	-------

**(e) 20 Mbps Premium Connection**

- Per Connection, Fixed Mode

900.00	1,522.80	MTEP4
--------	----------	-------

- Per Connection, Burst Mode

900.00	1,711.80	MTEE4
--------	----------	-------

**(f) 50 Mbps Premium Connection**

- Per Connection, Fixed Mode

900.00	2,008.80	MTEP5
--------	----------	-------

- Per Connection, Burst Mode

900.00	2,085.75	MTEE5
--------	----------	-------

**(g) 100 Mbps Premium Connection**

- Per Connection, Fixed Mode

1,000.00	2,430.00	MTEP6
----------	----------	-------

- Per Connection, Burst Mode

1,000.00	2,724.30	MTEE6
----------	----------	-------

**(h) 250 Mbps Premium Connection**

- Per Connection, Fixed Mode

1,000.00	3,034.80	MTEP7
----------	----------	-------

- Per Connection, Burst Mode

1,000.00	3,260.25	MTEE7
----------	----------	-------

**(i) 500 Mbps Premium Connection**

- Per Connection, Fixed Mode

1,000.00	4,039.20	MTEP8
----------	----------	-------

- Per Connection, Burst Mode

1,000.00	4,182.30	MTEE8
----------	----------	-------

**(j) 900 Mbps Premium Connection**

- Per Connection, Fixed Mode

1,500.00	5,988.60	MTEP9
----------	----------	-------

**3.**

**Note 1:** See Page 22.5.1 for service availability information.



BELLSOUTH  
TELECOMMUNICATIONS  
TENNESSEE

ACCESS SERVICES TARIFF

Third Revised Page 52.0.8.1  
Cancels Second Revised Page 52.0.8.1

ISSUED: May 25, 2023  
BY: Joelle Phillips, President - Tennessee  
Nashville, Tennessee

EFFECTIVE: June 15, 2023

**E7. SPECIAL ACCESS (A.K.A. BELLSOUTH SPA) SERVICE**

**E7.5 Rates and Charges (Cont'd)**

**E7.5.22 BellSouth Metro Ethernet Service (Cont'd)**

**A. Rates and charges for month-to-month service (Cont'd)**

**4. Virtual BellSouth Metro Ethernet Service Arrangements<sup>1, 2</sup>**

**(a) 2 Mbps Virtual Connection**

	<b>Nonrecurring Charge</b>	<b>Month to Month</b>	<b>USOC</b>
- Per Connection	\$ 1,000.00	\$ 523.80	MTEVO
<b>(b) 4 Mbps Virtual Connection</b>			
- Per Connection	1,000.00	561.60	MTEV1
<b>(c) 8 Mbps Virtual Connection</b>			
- Per Connection	1,000.00	680.40	MTEV2
<b>(d) 10 Mbps Virtual Connection</b>			
- Per Connection	1,000.00	1,004.40	MTEV3
<b>(e) 20 Mbps Virtual Connection</b>			
- Per Connection	1,000.00	1,306.80	MTEV4
<b>(f) 50 Mbps Virtual Connection</b>			
- Per Connection	1,000.00	1,792.80	MTEV5
<b>(g) 80 Mbps Virtual Connection</b>			
- Per Connection	1,000.00	2,003.40	MTEV6
<b>(h) 100 Mbps Virtual Connection</b>			
- Per Connection	1,500.00	2,214.00	MTEV7
<b>(i) 200 Mbps Virtual Connection</b>			
- Per Connection	1,500.00	2,818.80	MTEV8
<b>(j) 300 Mbps Virtual Connection</b>			
- Per Connection	1,500.00	3,180.60	MTEV9
<b>(k) 450 Mbps Virtual Connection</b>			
- Per Connection	1,500.00	3,823.20	MTEVA
<b>(l) 600 Mbps Virtual Connection</b>			
- Per Connection	1,750.00	4,541.40	MTEVB
<b>(m) 750 Mbps Virtual Connection</b>			
- Per Connection	1,750.00	5,292.00	MTEVC
<b>(n) 900 Mbps Virtual Connection</b>			
- Per Connection	2,000.00	5,772.60	MTEVD

**5. BellSouth Metro Ethernet Service Independent Company (ICO) Trunk Arrangements**

**(a) ICO Trunk Connection**

- Per VLAN Connection	1,300.00	1,046.25	MTEGC
-----------------------	----------	----------	-------

**Note 1:** Each Virtual Connection requires the establishment of a Class of Service (CoS) profile.

**Note 2:** See Page 22.5.1 for service availability information.

BELLSOUTH  
TELECOMMUNICATIONS  
TENNESSEE

ACCESS SERVICES TARIFF

Sixth Revised Page 52.0.9  
Cancels Fifth Revised Page 52.0.9

ISSUED: May 25, 2023  
BY: Joelle Phillips, President - Tennessee  
Nashville, Tennessee

EFFECTIVE: June 15, 2023

**E7. SPECIAL ACCESS (A.K.A. BELLSOUTH SPA) SERVICE**

**E7.5 Rates and Charges (Cont'd)**

**E7.5.22 BellSouth Metro Ethernet Service<sup>1</sup> (Cont'd)**

**A. Rates and charges for month-to-month service (Cont'd)**

**6. BellSouth Metro Ethernet Service Additional Mileage**

- (a) BellSouth Metro Ethernet Service Additional Mileage:  
BellSouth Metro Ethernet Service arrangements greater than  
10 miles through 25 airline miles

	<b>Month to Month</b>	<b>USOC</b>	
- Per 2 – 9 Mbps Connection	\$ 432.00	MTEMO	(1)
- Per 10 – 99 Mbps Connection	449.55	MTEMA	
- Per 100 – 499 Mbps Connection	558.90	MTEMB	
- Per 500 Mbps – 1 Gbps Connection	680.40	MTEMC	

- (b) BellSouth Metro Ethernet Service Additional Mileage:  
BellSouth Metro Ethernet Service arrangements greater than  
25 miles through 35 airline miles

- Per 2 – 9 Mbps Connection	708.75	MTEMD	
- Per 10 – 99 Mbps Connection	753.30	MTEME	
- Per 100 – 499 Mbps Connection	947.70	MTEMF	
- Per 500 Mbps – 1 Gbps Connection	1,129.95	MTEMG	

- (c) BellSouth Metro Ethernet Service Additional Mileage:  
BellSouth Metro Ethernet Service arrangements greater than  
35 miles through 50 airline miles

- Per 2 – 9 Mbps Connection	1,080.00	MTEMH	
- Per 10 – 99 Mbps Connection	1,178.55	MTEMJ	
- Per 100 – 499 Mbps Connection	1,470.15	MTEMK	
- Per 500 Mbps – 1 Gbps Connection	1,773.90	MTEML	(1)

**7. BellSouth Metro Ethernet Service Independent Company (ICO) Trunk Additional Mileage Charges**

- (a) BellSouth Metro Ethernet Service ICO Trunk Additional Mileage:  
BellSouth Metro Ethernet Service ICO Trunk arrangements greater than  
10 miles through 25 airline miles  
- per VLAN Connection

229.50	MTEM1	(1)
--------	-------	-----

- (b) BellSouth Metro Ethernet Service ICO Trunk Additional Mileage:  
BellSouth Metro Ethernet Service ICO Trunk arrangements greater than  
25 miles through 35 airline miles  
- per VLAN Connection

567.00	MTEM2	(1)
--------	-------	-----

- (c) BellSouth Metro Ethernet Service ICO Trunk Additional Mileage:  
BellSouth Metro Ethernet Service ICO Trunk arrangements greater than  
35 miles through 50 airline miles  
- per VLAN Connection

911.25	MTEM3	(1)
--------	-------	-----

**Note 1:** See Page 22.5.1 for service availability information.

BELLSOUTH  
TELECOMMUNICATIONS  
TENNESSEE

## ACCESS SERVICES TARIFF

Fifth Revised Page 52.0.10  
Cancels Fourth Revised Page 52.0.10

ISSUED: May 25, 2023

EFFECTIVE: June 15, 2023

BY: Joelle Phillips, President - Tennessee  
Nashville, Tennessee

**E7. SPECIAL ACCESS (A.K.A. BELLSOUTH SPA) SERVICE****E7.5 Rates and Charges (Cont'd)****E7.5.22 BellSouth Metro Ethernet Service<sup>4</sup> (Cont'd)****A. Rates and charges for month-to-month service (Cont'd)****8. Priority Plus Feature<sup>1</sup>**

	Nonrecurring Charge	Month to Month	USOC	
- Per Connection	\$ -	\$ 162.00	MTEP	(1)
<b>9. Q-Forwarding Feature<sup>1</sup></b>				
(a) Q-Forwarding Service Establishment Charge	400.00	-	MTEQF	
- Per Connection				
(b) Q-Forwarding Network Assignment Charge	-	108.00	MTEQN	(1)
- Per Network, Per Connection				
<b>10. VLAN Aggregation Feature<sup>2</sup></b>				
(a) VLAN Aggregation Service Establishment Charge	400.00	-	MTEQE	
- Per Connection				
(b) VLAN Aggregation Network Assignment Charge	-	108.00	MTEQV	(1)
- Per VLAN, Per Connection				
<b>11. CNM - Metro Ethernet Reporting Feature<sup>3</sup></b>				
(a) CNM - Metro Ethernet Reporting, Service Establishment Charge	225.00	-	MTERE	
- Per Customer Account				
(b) CNM - Metro Ethernet Reporting Charge	-	13.50	MTERC	(1)
- Per Connection				
(c) CNM - Metro Ethernet Reporting, Web Interface Charge	-	-	MTER1	
- First	65.00	27.00	MTERW	(1)
- Each Additional				
(d) CNM - Metro Ethernet Reporting, Security Card	200.00	-	MTERS	
- Each				

**Note 1:** Optional feature only available with a Premium Connection.

**Note 2:** Optional feature only available with a Virtual Connection.

**Note 3:** Optional feature only available with a Premium or Virtual Connection.

**Note 4:** See Page 22.5.1 for service availability information.

BELLSOUTH  
TELECOMMUNICATIONS  
TENNESSEE

ACCESS SERVICES TARIFF

Second Revised Page 52.0.10.0.1  
Cancels First Revised Page 52.0.10.0.1

ISSUED: May 25, 2023  
BY: Joelle Phillips, President - Tennessee  
Nashville, Tennessee

EFFECTIVE: June 15, 2023

**E7. SPECIAL ACCESS (A.K.A. BELLSOUTH SPA) SERVICE**

**E7.5 Rates and Charges (Cont'd)**

**E7.5.22 BellSouth Metro Ethernet Service<sup>3</sup> (Cont'd)**

**A. Rates and charges for month-to-month service (Cont'd)**

**12. Class of Service (CoS) Profile<sup>1</sup>**

**(a) Real-Time CoS<sup>2</sup>**

	<b>Month to Month</b>	<b>USOC</b>
- 10%	\$ 72.90	MTETF
- 20%	145.80	MTETG
- 25%	182.25	MTETH
- 30%	218.70	MTETJ
- 35%	255.15	MTETK
- 40%	291.60	MTETL
- 50%	364.50	MTETM
- 70%	510.30	MTETO

**(b) Interactive CoS<sup>2</sup>**

- 10%	60.75	MTEVF
- 20%	121.50	MTEVG
- 25%	151.20	MTEVH
- 30%	182.25	MTEVJ
- 35%	211.95	MTEVK
- 40%	243.00	MTEVL
- 50%	303.75	MTEVM

**Note 1:** Each Virtual Connection requires the designation of a CoS profile with desired percentages of each CoS selected. The sum of the percentages for all CoS selected for a Virtual Connection must sum to 100%.

**Note 2:** The combined CoS bandwidth percentages selected in a customer's Virtual Connection CoS profile for Real-Time CoS plus Interactive CoS may not exceed 50%, except where the customer selects the 70% Real-Time CoS bandwidth percentage and has no Interactive traffic.

**Note 3:** See Page 22.5.1 for service availability information.

(1)

BELLSOUTH  
TELECOMMUNICATIONS  
TENNESSEE

ACCESS SERVICES TARIFF

Third Revised Page 52.0.10.0.2  
Cancels Second Revised Page 52.0.10.0.2

ISSUED: May 25, 2023  
BY: Joelle Phillips, President - Tennessee  
Nashville, Tennessee

EFFECTIVE: June 15, 2023

**E7. SPECIAL ACCESS (A.K.A. BELLSOUTH SPA) SERVICE**

**E7.5 Rates and Charges (Cont'd)**

**E7.5.22 BellSouth Metro Ethernet Service (Cont'd)<sup>2</sup>**

**A. Rates and charges for month-to-month service (Cont'd)**

**12. Class of Service (CoS) Profile<sup>1</sup> (Cont'd)**

(c) Business Critical CoS

	<b>Month to Month</b>	<b>USOC</b>
- 10%	\$ 36.45	MTEPF
- 20%	72.90	MTEPG
- 25%	90.45	MTEPH
- 30%	109.35	MTEPJ
- 35%	126.90	MTEPK
- 40%	145.80	MTEPL
- 50%	182.25	MTEPM
- 60%	218.70	MTEPN
- 75%	272.70	MTEPP
- 90%	328.05	MTEPQ
- 100%	364.50	MTEPR

(d) Best Effort CoS

- 10%	12.15	MTEBF
- 20%	24.30	MTEBG
- 25%	29.70	MTEBH
- 30%	36.45	MTEBJ
- 35%	41.85	MTEBK
- 40%	48.60	MTEBL
- 50%	60.75	MTEBM
- 60%	72.90	MTEBN
- 75%	90.45	MTEBP
- 90%	109.35	MTEBQ

**Note 1:** Each Virtual Connection requires the designation of a CoS profile with desired percentages of each CoS selected. The sum of the percentages for all CoS selected for a Virtual Connection must sum to 100%.

**Note 2:** Effective on or after August 22, 2021, this Service will no longer be available for purchase by new or existing customers. In addition, requests to move, add, change, or renew existing service arrangements will not be accepted. Following the expiration of a customer's existing term agreement, service will be provided on a month-to-month basis at the applicable Monthly rates until the service is discontinued. The Company currently plans to discontinue this service on or after March 31, 2023.

(1) \_\_\_\_\_ (1)

BELLSOUTH  
TELECOMMUNICATIONS  
TENNESSEE

ACCESS SERVICES TARIFF

Fifth Revised Page 52.0.10.1  
Cancels Fourth Revised Page 52.0.10.1

ISSUED: May 25, 2023  
BY: Joelle Phillips, President - Tennessee  
Nashville, Tennessee

EFFECTIVE: June 15, 2023

**E7. SPECIAL ACCESS (A.K.A. BELLSOUTH SPA) SERVICE**

**E7.5 Rates and Charges (Cont'd)**

**E7.5.22 BellSouth Metro Ethernet Service (Cont'd)<sup>3</sup>**

**A. Rates and charges for month-to-month service (Cont'd)**

**13. Automatic Protection Switching (APS) Feature<sup>1</sup>:** Selected to provide automatic protection switching in conjunction with a Basic, Premium or Virtual BellSouth Metro Ethernet Connection of 10 Mbps or higher. Applicable APS rate element based upon type of APS selected and actual total route miles<sup>2</sup> (rounded up to next whole mile) based upon a customer-specific design as determined by the Telephone Company.

(a) Structural Protection

	<b>Nonrecurring Charge</b>	<b>Month to Month</b>	<b>USOC</b>
- Per APS Arrangement of less than 10 route miles	\$ 1000.00	\$ 2,565.00	MTEAO
- Per APS Arrangement of 10 through 25 route miles	1500.00	2,895.75	MTEA1
- Per APS Arrangement of greater than 25 through 35 route miles	2000.00	3,300.75	MTEA2
- Per APS Arrangement of greater than 35 through 50 route miles	2500.00	3,915.00	MTEA3

(b) Route Protection

- Per APS Arrangement of less than 10 route miles	1500.00	3,132.00	MTEA5
- Per APS Arrangement of 10 through 25 route miles	2000.00	3,523.50	MTEA6
- Per APS Arrangement of greater than 25 through 35 route miles	2500.00	4,002.75	MTEA7
- Per APS Arrangement of greater than 35 through 50 route miles	3000.00	4,637.25	MTEA8

**14. Optical Termination Charge:** An electrical termination on the customer premises is standard for 2, 4 and 8 Mbps Basic, Premium and Virtual Connections. Therefore, an Optical Termination Charge applies when an optional optical termination is requested and provided for a 2, 4 or 8 Mbps Connection.

(a) Per Optical Termination

- Per Connection	-	40.50	MTEO1
------------------	---	-------	-------

**15. Service Reconfiguration Charge**

(a) Per Request

- Per Connection	200.00	-	MTESR
------------------	--------	---	-------

**16. System Reconfiguration Charge**

(a) Per Request

- Per Connection	900.00	-	MTESY
------------------	--------	---	-------

**Note 1:** Optional feature only available with a Basic, Premium or Virtual Connection of 10 Mbps or higher. (APS is not available for a 2 Mbps, 4 Mbps or 8 Mbps Basic, Premium or Virtual Connection).

**Note 2:** Per definition of route mileage provided in E7.2.18U preceding.

**Note 3:** Effective on or after August 22, 2021, this Service will no longer be available for purchase by new or existing customers. In addition, requests to move, add, change, or renew existing service arrangements will not be accepted. Following the expiration of a customer's existing term agreement, service will be provided on a month-to-month basis at the applicable Monthly rates until the service is discontinued. The Company currently plans to discontinue this service on or after March 31, 2023.

BELLSOUTH  
TELECOMMUNICATIONS  
TENNESSEE

ACCESS SERVICES TARIFF

Seventh Revised Page 52.0.11  
Cancels Sixth Revised Page 52.0.11

ISSUED: July 30, 2021

EFFECTIVE: August 22, 2021

BY: Joelle Phillips, President - Tennessee  
Nashville, Tennessee

**E7. SPECIAL ACCESS (A.K.A. BELLSOUTH SPA) SERVICE**

**E7.5 Rates and Charges (Cont'd)**

**E7.5.22 BellSouth Metro Ethernet Service (Cont'd)<sup>2</sup>**

(C)

**B. Rates and charges for Transport Payment Plan**

**1. Basic BellSouth Metro Ethernet Service Arrangements**

**(a) 2 Mbps Basic Connection**

	Nonrecurring Charge	Transport Payment Plan Rates			USOC
		A 12-36 Mos	B 37-60 Mos <sup>1</sup>	C 61-96 Mos <sup>1</sup>	
- Per Connection	\$ -	\$ 380.00	\$ 360.00	\$ 345.00	MTEBO
(b) 4 Mbps Basic Connection	-	500.00	415.00	395.00	MTEB1
- Per Connection	-	540.00	475.00	450.00	MTEB2
(c) 8 Mbps Basic Connection	-	630.00	599.00	550.00	MTEBA
- Per Connection	-	1,180.00	1,121.00	1,065.00	MTEBB
(d) 10 Mbps Basic Connection	-	2,565.00	2,437.00	2,315.00	MTEBC
- Per Connection	-				

**2. Premium BellSouth Metro Ethernet Service Arrangements**

(a) 2 Mbps Premium Connection	-	500.00	435.00	415.00	MTEPO
- Per Connection, Fixed Mode	-	540.00	470.00	445.00	MTEP1
(b) 4 Mbps Premium Connection	-	640.00	510.00	485.00	MTEP2
- Per Connection, Fixed Mode	-	720.00	684.00	650.00	MTEP3
(c) 8 Mbps Premium Connection	-	900.00	855.00	812.00	MTEE3
- Per Connection, Fixed Mode	-	904.00	859.00	816.00	MTEP4
(d) 10 Mbps Premium Connection	-	1,013.00	962.00	914.00	MTEE4
- Per Connection, Fixed Mode	-	1,192.00	1,132.00	1,075.00	MTEP5
(e) 20 Mbps Premium Connection	-	1,238.00	1,176.00	1,117.00	MTEE5
- Per Connection, Fixed Mode	-	1,440.00	1,368.00	1,300.00	MTEP6
(f) 50 Mbps Premium Connection	-	1,613.00	1,532.00	1,455.00	MTEE6
- Per Connection, Fixed Mode	-	1,800.00	1,710.00	1,625.00	MTEP7
(g) 100 Mbps Premium Connection	-	1,935.00	1,838.00	1,746.00	MTEE7
- Per Connection, Fixed Mode	-	2,392.00	2,272.00	2,158.00	MTEP8
(h) 250 Mbps Premium Connection	-	2,475.00	2,351.00	2,233.00	MTEE8
- Per Connection, Fixed Mode	-	3,700.00	3,532.00	3,356.00	MTEP9

**Note 1:** All term plans for BellSouth Metro Ethernet Service which are established, renewed or extended after December 16, 2013, for term lengths which are scheduled to expire at any time after October 1, 2018, will instead expire on October 1, 2018. All such services existing on or after October 1, 2018, will be provided on a month-to-month basis at the applicable, then current month-to-month rates. Notwithstanding anything to the contrary in the previous two sentences, this footnote does not apply to any term plans established, renewed or extended after November 11, 2016.

**Note 2:** Effective on or after August 22, 2021, this Service will no longer be available for purchase by new or existing customers. In addition, requests to move, add, change, or renew existing service arrangements will not be accepted. Following the expiration of a customer's existing term agreement, service will be provided on a month-to-month basis at the applicable Monthly rates until the service is discontinued. The Company currently plans to discontinue this service on or after March 31, 2023.

(N)

(N)

BELLSOUTH  
TELECOMMUNICATIONS  
TENNESSEE

ACCESS SERVICES TARIFF

Sixth Revised Page 52.0.11.1  
Cancels Fifth Revised Page 52.0.11.1

ISSUED: July 30, 2021

EFFECTIVE: August 22, 2021

BY: Joelle Phillips, President - Tennessee  
Nashville, Tennessee

**E7. SPECIAL ACCESS (A.K.A. BELLSOUTH SPA) SERVICE**

**E7.5 Rates and Charges (Cont'd)**

**E7.5.22 BellSouth Metro Ethernet Service (Cont'd)<sup>3</sup>**

(C)

**B. Rates and charges for Transport Payment Plan (Cont'd)**

4. Virtual BellSouth Metro Ethernet Service Arrangements<sup>1</sup>

(a) 2 Mbps Virtual Connection

	Nonrecurring Charge	Transport Payment Plan Rates			USOC
		A 12-36 Mos	B 37-60 Mos <sup>2</sup>	C 61-96 Mos <sup>2</sup>	
- Per Connection	\$ -	\$ 340.00	\$ 321.00	\$ 305.00	MTEVO
(b) 4 Mbps Virtual Connection					
- Per Connection	-	380.00	359.00	341.00	MTEV1
(c) 8 Mbps Virtual Connection					
- Per Connection	-	480.00	454.00	431.00	MTEV2
(d) 10 Mbps Virtual Connection					
- Per Connection	-	560.00	529.00	503.00	MTEV3
(e) 20 Mbps Virtual Connection					
- Per Connection	-	744.00	703.00	668.00	MTEV4
(f) 50 Mbps Virtual Connection					
- Per Connection	-	1,032.00	975.00	926.00	MTEV5
(g) 80 Mbps Virtual Connection					
- Per Connection	-	1,156.00	1,092.00	1,038.00	MTEV6
(h) 100 Mbps Virtual Connection					
- Per Connection	-	1,280.00	1,210.00	1,149.00	MTEV7
(i) 200 Mbps Virtual Connection					
- Per Connection	-	1,640.00	1,550.00	1,472.00	MTEV8
(j) 300 Mbps Virtual Connection					
- Per Connection	-	1,936.00	1,830.00	1,738.00	MTEV9
(k) 450 Mbps Virtual Connection					
- Per Connection	-	2,232.00	2,109.00	2,004.00	MTEVA
(l) 600 Mbps Virtual Connection					
- Per Connection	-	2,660.00	2,514.00	2,388.00	MTEVB
(m) 750 Mbps Virtual Connection					
- Per Connection	-	3,104.00	2,933.00	2,787.00	MTEVC
(n) 900 Mbps Virtual Connection					
- Per Connection	-	3,540.00	3,345.00	3,178.00	MTEVD

5. BellSouth Metro Ethernet Service Independent Company (ICO) Trunk Arrangements

(a) ICO Trunk Connection  
- Per VLAN Connection

-	500.00	450.00	405.00	MTEGC
---	--------	--------	--------	-------

**Note 1:** Each Virtual Connection requires the establishment of a Class of Service (CoS) profile.

**Note 2:** All term plans for BellSouth Metro Ethernet Service which are established, renewed or extended after December 16, 2013, for term lengths which are scheduled to expire at any time after October 1, 2018, will instead expire on October 1, 2018. All such services existing on or after October 1, 2018, will be provided on a month-to-month basis at the applicable, then current month-to-month rates. Notwithstanding anything to the contrary in the previous two sentences, this footnote does not apply to any term plans established, renewed or extended after November 11, 2016.

**Note 3:** Effective on or after August 22, 2021, this Service will no longer be available for purchase by new or existing customers. In addition, requests to move, add, change, or renew existing service arrangements will not be accepted. Following the expiration of a customer's existing term agreement, service will be provided on a month-to-month basis at the applicable Monthly rates until the service is discontinued. The Company currently plans to discontinue this service on or after March 31, 2023.

(N)  
|  
(N)



BELLSOUTH  
TELECOMMUNICATIONS  
TENNESSEE

ACCESS SERVICES TARIFF

Ninth Revised Page 52.0.12  
Cancels Eighth Revised Page 52.0.12

ISSUED: July 30, 2021  
BY: Joelle Phillips, President - Tennessee  
Nashville, Tennessee

EFFECTIVE: August 22, 2021

**E7. SPECIAL ACCESS (A.K.A. BELLSOUTH SPA) SERVICE**

**E7.5 Rates and Charges (Cont'd)**

**E7.5.22 BellSouth Metro Ethernet Service (Cont'd)<sup>2</sup>**

(C)

**B. Rates and charges for Transport Payment Plan (Cont'd)**

**6. BellSouth Metro Ethernet Service Additional Mileage**

- (a) BellSouth Metro Ethernet Service Additional Mileage:  
BellSouth Metro Ethernet Service arrangements greater than  
10 miles through 25 airline miles

	Transport Payment Plan Rates				USOC
	Nonrecurring Charge	A 12-36 Mos	B 37-60 Mos <sup>1</sup>	C 61-96 Mos <sup>1</sup>	
- Per 2 – 9 Mbps Connection	\$ -	\$ 320.00	\$ 320.00	\$ 320.00	MTEMO
- Per 10 – 99 Mbps Connection	-	333.00	333.00	333.00	MTEMA
- Per 100 – 499 Mbps Connection	-	414.00	414.00	414.00	MTEMB
- Per 500 Mbps – 1 Gbps Connection	-	504.00	504.00	504.00	MTEMC

- (b) BellSouth Metro Ethernet Service Additional Mileage:  
BellSouth Metro Ethernet Service arrangements greater than  
25 miles through 35 airline miles

- Per 2 – 9 Mbps Connection	-	525.00	525.00	525.00	MTEMD
- Per 10 – 99 Mbps Connection	-	558.00	558.00	558.00	MTEME
- Per 100 – 499 Mbps Connection	-	702.00	702.00	702.00	MTEMF
- Per 500 Mbps – 1 Gbps Connection	-	837.00	837.00	837.00	MTEMG

- (c) BellSouth Metro Ethernet Service Additional Mileage:  
BellSouth Metro Ethernet Service arrangements greater than  
35 miles through 50 airline miles

- Per 2 – 9 Mbps Connection	-	800.00	800.00	800.00	MTEMH
- Per 10 – 99 Mbps Connection	-	873.00	873.00	873.00	MTEMJ
- Per 100 – 499 Mbps Connection	-	1,089.00	1,089.00	1,089.00	MTEMK
- Per 500 Mbps – 1 Gbps Connection	-	1,314.00	1,314.00	1,314.00	MTEML

**7. BellSouth Metro Ethernet Service Independent Company (ICO) Trunk Additional Mileage Charges**

- (a) BellSouth Metro Ethernet Service ICO Trunk Additional Mileage:  
BellSouth Metro Ethernet Service ICO Trunk arrangements greater than  
10 miles through 25 airline miles

- per VLAN Connection	-	170.00	170.00	170.00	MTEMI
-----------------------	---	--------	--------	--------	-------

- (b) BellSouth Metro Ethernet Service ICO Trunk Additional Mileage:  
BellSouth Metro Ethernet Service ICO Trunk arrangements greater than  
25 miles through 35 airline miles

- per VLAN Connection	-	420.00	420.00	420.00	MTEM2
-----------------------	---	--------	--------	--------	-------

- (c) BellSouth Metro Ethernet Service ICO Trunk Additional Mileage:  
BellSouth Metro Ethernet Service ICO Trunk arrangements greater than  
35 miles through 50 airline miles

- per VLAN Connection	-	675.00	675.00	675.00	MTEM3
-----------------------	---	--------	--------	--------	-------

**Note 1:** All term plans for BellSouth Metro Ethernet Service which are established, renewed or extended after December 16, 2013, for term lengths which are scheduled to expire at any time after October 1, 2018, will instead expire on October 1, 2018. All such services existing on or after October 1, 2018, will be provided on a month-to-month basis at the applicable, then current month-to-month rates. Notwithstanding anything to the contrary in the previous two sentences, this footnote does not apply to any term plans established, renewed or extended after November 11, 2016.

**Note 2:** Effective on or after August 22, 2021, this Service will no longer be available for purchase by new or existing customers. In addition, requests to move, add, change, or renew existing service arrangements will not be accepted. Following the expiration of a customer's existing term agreement, service will be provided on a month-to-month basis at the applicable Monthly rates until the service is discontinued. The Company currently plans to discontinue this service on or after March 31, 2023.

(N)

BELLSOUTH  
TELECOMMUNICATIONS  
TENNESSEE

ACCESS SERVICES TARIFF

Seventh Revised Page 52.0.13  
Cancels Sixth Revised Page 52.0.13

ISSUED: July 30, 2021

EFFECTIVE: August 22, 2021

BY: Joelle Phillips, President - Tennessee  
Nashville, Tennessee

**E7. SPECIAL ACCESS (A.K.A. BELLSOUTH SPA) SERVICE**

**E7.5 Rates and Charges (Cont'd)**

**E7.5.22 BellSouth Metro Ethernet Service (Cont'd)<sup>5</sup>**

(C)

**B. Rates and charges for Transport Payment Plan (Cont'd)**

**8. Priority Plus Feature<sup>1</sup>**

- Per Connection

Transport Payment Plan Rates				
	A	B	C	
Nonrecurring Charge <sup>2</sup>	12-36 Mos	37-60 Mos <sup>4</sup>	61-96 Mos <sup>4</sup>	USOC
\$ -	\$ 95.00	\$ 85.00	\$ 80.00	MTEFP

**9. Q-Forwarding Feature<sup>1</sup>**

**(a) Q-Forwarding Service Establishment Charge**

- Per Connection

Nonrecurring Charge <sup>2</sup>	USOC
\$400.00	MTEQF

**(b) Q-Forwarding Network Assignment Charge**

- Per Network, Per Connection

Transport Payment Plan Rates				
	A	B	C	
Nonrecurring Charge <sup>2</sup>	12-36 Mos	37-60 Mos <sup>4</sup>	61-96 Mos <sup>4</sup>	USOC
\$ -	\$ 65.00	\$ 60.00	\$ 55.00	MTEQN

**10. VLAN Aggregation Feature<sup>3</sup>**

**(a) VLAN Aggregation Service Establishment Charge**

- Per Connection

Nonrecurring Charge <sup>2</sup>	USOC
\$400.00	MTEQE

**(b) VLAN Aggregation Network Assignment Charge**

- Per VLAN, Per Connection

Transport Payment Plan Rates				
	A	B	C	
Nonrecurring Charge <sup>2</sup>	12-36 Mos	37-60 Mos <sup>4</sup>	61-96 Mos <sup>4</sup>	USOC
\$ -	\$ 65.00	\$ 60.00	\$ 55.00	MTEQV

**Note 1:** Optional feature only available with a Premium Connection.

**Note 2:** This nonrecurring charge is applicable to service under a TPP arrangement.

**Note 3:** Optional feature only available with a Virtual Connection.

**Note 4:** All term plans for BellSouth Metro Ethernet Service which are established, renewed or extended after December 16, 2013, for term lengths which are scheduled to expire at any time after October 1, 2018, will instead expire on October 1, 2018. All such services existing on or after October 1, 2018, will be provided on a month-to-month basis at the applicable, then current month-to-month rates. Notwithstanding anything to the contrary in the previous two sentences, this footnote does not apply to any term plans established, renewed or extended after November 11, 2016.

**Note 5:** Effective on or after August 22, 2021, this Service will no longer be available for purchase by new or existing customers. In addition, requests to move, add, change, or renew existing service arrangements will not be accepted. Following the expiration of a customer's existing term agreement, service will be provided on a month-to-month basis at the applicable Monthly rates until the service is discontinued. The Company currently plans to discontinue this service on or after March 31, 2023.

(N)  
|  
(N)

BELLSOUTH  
TELECOMMUNICATIONS  
TENNESSEE

ACCESS SERVICES TARIFF

Sixth Revised Page 52.0.13.1  
Cancels Fifth Revised Page 52.0.13.1

ISSUED: July 30, 2021  
BY: Joelle Phillips, President - Tennessee  
Nashville, Tennessee

EFFECTIVE: August 22, 2021

**E7. SPECIAL ACCESS (A.K.A. BELLSOUTH SPA) SERVICE**

**E7.5 Rates and Charges (Cont'd)**

**E7.5.22 BellSouth Metro Ethernet Service (Cont'd)<sup>4</sup>**

(C)

**B. Rates and charges for Transport Payment Plan (Cont'd)**

**II. CNM - Metro Ethernet Reporting Feature<sup>1</sup>**

- (a) CNM - Metro Ethernet Reporting, Service Establishment Charge

**Nonrecurring Charge<sup>2</sup>**      **USOC**  
\$ 225.00      **MTERE**

- Per Customer Account

- (b) CNM - Metro Ethernet Reporting Charge

**Transport Payment Plan Rates**

		A	B	C	
<b>Nonrecurring Charge<sup>2</sup></b>	<b>12-36</b>	<b>37-60</b>	<b>61-96</b>	<b>Mos<sup>3</sup></b>	<b>USOC</b>
\$ -	\$ 8.00	\$ 6.00	\$ 5.00	MTERC	

- Per Connection

- (c) CNM - Metro Ethernet Reporting, Web Interface Charge

- First

- Each Additional

	-	-	-	-	<b>MTER1</b>
<b>65.00</b>	<b>18.00</b>	<b>15.00</b>	<b>13.00</b>	<b>MTERW</b>	

- (d) CNM - Metro Ethernet Reporting, Security Card

- Each

**Nonrecurring Charge<sup>2</sup>**      **USOC**  
\$ 200.00      **MTERS**

**Note 1:** Optional feature only available with a Premium or Virtual Connection.

**Note 2:** This nonrecurring charge is applicable to service under a TPP arrangement.

**Note 3:** All term plans for BellSouth Metro Ethernet Service which are established, renewed or extended after December 16, 2013, for term lengths which are scheduled to expire at any time after October 1, 2018, will instead expire on October 1, 2018. All such services existing on or after October 1, 2018, will be provided on a month-to-month basis at the applicable, then current month-to-month rates. Notwithstanding anything to the contrary in the previous two sentences, this footnote does not apply to any term plans established, renewed or extended after November 11, 2016.

**Note 4:** Effective on or after August 22, 2021, this Service will no longer be available for purchase by new or existing customers. In addition, requests to move, add, change, or renew existing service arrangements will not be accepted. Following the expiration of a customer's existing term agreement, service will be provided on a month-to-month basis at the applicable Monthly rates until the service is discontinued. The Company currently plans to discontinue this service on or after March 31, 2023.

(N)  
|  
(N)

BELLSOUTH  
TELECOMMUNICATIONS  
TENNESSEE

ACCESS SERVICES TARIFF

Fifth Revised Page 52.0.13.2  
Cancels Fourth Revised Page 52.0.13.2

ISSUED: July 30, 2021

EFFECTIVE: August 22, 2021

BY: Joelle Phillips, President - Tennessee  
Nashville, Tennessee

**E7. SPECIAL ACCESS (A.K.A. BELLSOUTH SPA) SERVICE**

**E7.5 Rates and Charges (Cont'd)**

**E7.5.22 BellSouth Metro Ethernet Service (Cont'd)<sup>5</sup>**

(C)

**B. Rates and charges for Transport Payment Plan (Cont'd)**

**12. Class of Service (CoS) Profile<sup>1</sup>**

(a) Real-Time CoS<sup>2</sup>

	Transport Payment Plan Rates				USOC
	Nonrecurring Charge <sup>3</sup>	A 12-36 Mos	B 37-60 Mos <sup>4</sup>	C 61-96 Mos <sup>4</sup>	
- 10%	\$ -	\$ 54.00	\$ 54.00	\$ 54.00	MTETF
- 20%	-	108.00	108.00	108.00	MTETG
- 25%	-	135.00	135.00	135.00	MTETH
- 30%	-	162.00	162.00	162.00	MTETJ
- 35%	-	189.00	189.00	189.00	MTETK
- 40%	-	216.00	216.00	216.00	MTETL
- 50%	-	270.00	270.00	270.00	MTETM
- 70%	-	378.00	378.00	378.00	MTETO

(b) Interactive CoS<sup>2</sup>

- 10%	-	45.00	45.00	45.00	MTEVF
- 20%	-	90.00	90.00	90.00	MTEVG
- 25%	-	112.00	112.00	112.00	MTEVH
- 30%	-	135.00	135.00	135.00	MTEVJ
- 35%	-	157.00	157.00	157.00	MTEVK
- 40%	-	180.00	180.00	180.00	MTEVL
- 50%	-	225.00	225.00	225.00	MTEVM

**Note 1:** Each Virtual Connection requires the designation of a CoS profile with desired percentages of each CoS selected. The sum of the percentages for all CoS selected for a Virtual Connection must sum to 100%..

**Note 2:** The combined CoS bandwidth percentages selected in a customer's Virtual Connection CoS profile for Real-Time CoS plus Interactive CoS may not exceed 50%, except where the customer selects the 70% Real-Time CoS bandwidth percentage and has no Interactive traffic.

**Note 3:** This nonrecurring charge is applicable to service under a TPP Arrangement.

**Note 4:** All term plans for BellSouth Metro Ethernet Service which are established, renewed or extended after December 16, 2013, for term lengths which are scheduled to expire at any time after October 1, 2018, will instead expire on October 1, 2018. All such services existing on or after October 1, 2018, will be provided on a month-to-month basis at the applicable, then current month-to-month rates. Notwithstanding anything to the contrary in the previous two sentences, this footnote does not apply to any term plans established, renewed or extended after November 11, 2016.

**Note 5:** Effective on or after August 22, 2021, this Service will no longer be available for purchase by new or existing customers. In addition, (N) requests to move, add, change, or renew existing service arrangements will not be accepted. Following the expiration of a customer's existing term agreement, service will be provided on a month-to-month basis at the applicable Monthly rates until the service is discontinued. The Company currently plans to discontinue this service on or after March 31, 2023. (N)

BELLSOUTH  
TELECOMMUNICATIONS  
TENNESSEE

ACCESS SERVICES TARIFF

Fifth Revised Page 52.0.13.3  
Cancels Fourth Revised Page 52.0.13.3

ISSUED: July 30, 2021  
BY: Joelle Phillips, President - Tennessee  
Nashville, Tennessee

EFFECTIVE: August 22, 2021

**E7. SPECIAL ACCESS (A.K.A. BELLSOUTH SPA) SERVICE**

**E7.5 Rates and Charges (Cont'd)**

**E7.5.22 BellSouth Metro Ethernet Service (Cont'd)<sup>4</sup>**

(C)

**B. Rates and charges for Transport Payment Plan (Cont'd)**

**12. Class of Service (CoS) Profile<sup>1</sup> (Cont'd)**

(c) Business Critical CoS

	Transport Payment Plan Rates				USOC
	Nonrecurring Charge <sup>2</sup>	A 12-36 Mos	B 37-60 Mos <sup>3</sup>	C 61-96 Mos <sup>3</sup>	
- 10%	\$ -	\$ 27.00	\$ 27.00	\$ 27.00	MTEPF
- 20%	-	54.00	54.00	54.00	MTEPG
- 25%	-	67.00	67.00	67.00	MTEPH
- 30%	-	81.00	81.00	81.00	MTEPJ
- 35%	-	94.00	94.00	94.00	MTEPK
- 40%	-	108.00	108.00	108.00	MTEPL
- 50%	-	135.00	135.00	135.00	MTEPM
- 60%	-	162.00	162.00	162.00	MTEPN
- 75%	-	202.00	202.00	202.00	MTEPP
- 90%	-	243.00	243.00	243.00	MTEPQ
- 100%	-	270.00	270.00	270.00	MTEPR

(d) Best Effort CoS

- 10%	-	9.00	9.00	9.00	MTEBF
- 20%	-	18.00	18.00	18.00	MTEBG
- 25%	-	22.00	22.00	22.00	MTEBH
- 30%	-	27.00	27.00	27.00	MTEBJ
- 35%	-	31.00	31.00	31.00	MTEBK
- 40%	-	36.00	36.00	36.00	MTEBL
- 50%	-	45.00	45.00	45.00	MTEBM
- 60%	-	54.00	54.00	54.00	MTEBN
- 75%	-	67.00	67.00	67.00	MTEBP
- 90%	-	81.00	81.00	81.00	MTEBQ

**Note 1:** Each Virtual Connection requires the designation of a CoS profile with desired percentages of each CoS selected. The sum of the percentages for all CoS selected for a Virtual Connection must sum to 100%.

**Note 2:** This nonrecurring charge is applicable to service under a TPP Arrangement.

**Note 3:** All term plans for BellSouth Metro Ethernet Service which are established, renewed or extended after December 16, 2013, for term lengths which are scheduled to expire at any time after October 1, 2018, will instead expire on October 1, 2018. All such services existing on or after October 1, 2018, will be provided on a month-to-month basis at the applicable, then current month-to-month rates. Notwithstanding anything to the contrary in the previous two sentences, this footnote does not apply to any term plans established, renewed or extended after November 11, 2016.

**Note 4:** Effective on or after August 22, 2021, this Service will no longer be available for purchase by new or existing customers. In addition, requests to move, add, change, or renew existing service arrangements will not be accepted. Following the expiration of a customer's existing term agreement, service will be provided on a month-to-month basis at the applicable Monthly rates until the service is discontinued. The Company currently plans to discontinue this service on or after March 31, 2023.

(N)  
|  
(N)

BELLSOUTH  
TELECOMMUNICATIONS  
TENNESSEE

ACCESS SERVICES TARIFF

Seventh Revised Page 52.0.14  
Cancels Sixth Revised Page 52.0.14

ISSUED: July 30, 2021

EFFECTIVE: August 22, 2021

BY: Joelle Phillips, President - Tennessee  
Nashville, Tennessee

**E7. SPECIAL ACCESS (A.K.A. BELLSOUTH SPA) SERVICE**

**E7.5 Rates and Charges (Cont'd)**

**E7.5.22 BellSouth Metro Ethernet Service (Cont'd)<sup>5</sup>**

(C)

**B. Rates and charges for Transport Payment Plan (Cont'd)**

**13. Automatic Protection Switching (APS) Feature<sup>1</sup>:** Selected to provide automatic protection switching in conjunction with a Basic, Premium or Virtual BellSouth Metro Ethernet Connection of 10 Mbps or higher. Applicable APS rate element based upon type of APS selected and actual total route miles<sup>2</sup> (rounded up to next whole mile) based upon a customer-specific design as determined by the Telephone Company.

(a) Structural Protection

**Transport Payment Plan Rates**

	<b>Nonrecurring Charge<sup>3</sup></b>	<b>A 12-36 Mos</b>	<b>B 37-60 Mos<sup>4</sup></b>	<b>C 61-96 Mos<sup>4</sup></b>	<b>USOC</b>
- Per APS Arrangement of less than 10 route miles	\$ -	\$ 1250.00	\$ 1092.00	\$ 935.00	MTEAO
- Per APS Arrangement of 10 through 25 route miles	-	1496.00	1301.00	1126.00	MTEA1
- Per APS Arrangement of greater than 25 through 35 route miles	-	1798.00	1679.00	1530.00	MTEA2
- Per APS Arrangement of greater than 35 through 50 route miles	-	2452.00	2376.00	2134.00	MTEA3

(b) Route Protection

- Per APS Arrangement of less than 10 route miles	-	1470.00	1285.00	1100.00	MTEA5
- Per APS Arrangement of 10 through 25 route miles	-	1760.00	1530.00	1325.00	MTEA6
- Per APS Arrangement of greater than 25 through 35 route miles	-	2115.00	1975.00	1800.00	MTEA7
- Per APS Arrangement of greater than 35 through 50 route miles	-	2885.00	2795.00	2510.00	MTEA8

**14. Optical Termination Charge:** An electrical termination on the customer premises is standard for 2, 4 and 8 Mbps Basic, Premium and Virtual Connections. Therefore, an Optical Termination Charge applies when an optional optical termination is requested and provided for a 2, 4 or 8 Mbps Connection.

(a) Per Optical Termination

- Per Connection	-	30.00	30.00	30.00	MTEO1
------------------	---	-------	-------	-------	-------

**15. Service Reconfiguration Charge**

(a) Per Request

- Per Connection				<b>Nonrecurring Charge<sup>3</sup></b> \$ 200.00	<b>USOC</b> MTESR
------------------	--	--	--	---	----------------------

**14. System Reconfiguration Charge**

(a) Per Request

- Per Connection				900.00	MTESY
------------------	--	--	--	--------	-------

**Note 1:** Optional feature only available with a Basic, Premium or Virtual Connection.

**Note 2:** Per definition of route mileage provided in E7.2.18U preceding.

**Note 3:** This nonrecurring charge is applicable to service under a TPP arrangement.

**Note 4:** All term plans for BellSouth Metro Ethernet Service which are established, renewed or extended after December 16, 2013, for term lengths which are scheduled to expire at any time after October 1, 2018, will instead expire on October 1, 2018. All such services existing on or after October 1, 2018, will be provided on a month-to-month basis at the applicable, then current month-to-month rates. Notwithstanding anything to the contrary in the previous two sentences, this footnote does not apply to any term plans established, renewed or extended after November 11, 2016.

**Note 5:** Effective on or after August 22, 2021, this Service will no longer be available for purchase by new or existing customers. In addition, requests to move, add, change, or renew existing service arrangements will not be accepted. Following the expiration of a customer's existing term agreement, service will be provided on a month-to-month basis at the applicable Monthly rates until the service is discontinued. The Company currently plans to discontinue this service on or after March 31, 2023.

(N)

BELLSOUTH  
TELECOMMUNICATIONS  
TENNESSEE

ACCESS SERVICES TARIFF

Second Revised Page 52.1  
Cancels First Revised Page 52.1

ISSUED: February 24, 1997  
BY: Joelle Phillips, President - Tennessee  
Nashville, Tennessee

EFFECTIVE: March 26, 1997

## E7. SPECIAL ACCESS (A.K.A. BELLSOUTH SPA) SERVICE (T)

### E7.6 Reserved For Future Use

### E7.7 Custom Network (a.k.a. BellSouth Custom Network) Service (T)

The digital single special access portion of this service is a Flex-Price service and is regulated under Terms and Conditions as described in E2.1.14 of this Tariff.

#### E7.7.1 General

Custom Network (*a.k.a. BellSouth Custom Network*) Service is furnished to provide custom-designed Special Access (*a.k.a. BellSouth SPA*) service networks. Each network design is tarified herein as a Custom Network Service Arrangement, and each is further identified with a roman numeral designation (i.e., Custom Network Service Arrangement I). (T)

A Custom Network Service Arrangement is only available under a contractual payment period according to the regulations, terms and conditions specified herein. A Custom Network Service Arrangement is furnished for the provisioning of an individual end user network and is only available for resale to that end user.

The Special Access (*a.k.a. BellSouth SPA*) services provided in a Custom Network Service Arrangement are subject to the general regulations for service stated elsewhere in this Tariff, except where specified otherwise in a Custom Network Service Arrangement. (T)

In order to subscribe to a Custom Network Service Arrangement, the customer's network must meet the minimum requirements stated within that specific Custom Network Service Arrangement with regard to network design and size. The customer must also agree to the terms and conditions stated therein.

#### E7.7.2 Custom Network Service Arrangement I

##### A. General

Custom Network Service Arrangement I is provided to furnish a large data network composed of Special Access Voice Grade Data (*a.k.a. BellSouth SPA DS0 VG*) service (may be referred to as analog data or 4-wire analog data service) and Digital Data Access (*a.k.a. BellSouth SPA DS0 Digital Data*) service (may be referred to as digital data or 4-wire digital data service). (T)

This arrangement will provide the regulations, and rates and charges to allow the transition of a primarily analog data network to a digital data network by the end of the specified payment period.

The analog data service and digital data service provided in Custom Network Service Arrangement I will be subject to the regulations in this Tariff which apply to Special Access Voice Grade Data (*a.k.a. BellSouth SPA DS0 VG*) service and Digital Data Access (*a.k.a. BellSouth SPA DS0 Digital Data*) service from Section E7., except where stated otherwise herein. (T)

BELLSOUTH  
TELECOMMUNICATIONS  
TENNESSEE

ACCESS SERVICES TARIFF

Third Revised Page 53  
Cancels Second Revised Page 53

ISSUED: February 24, 1997  
BY: Joelle Phillips, President - Tennessee  
Nashville, Tennessee

EFFECTIVE: March 26, 1997

## E7. SPECIAL ACCESS (A.K.A. BELLSOUTH SPA) SERVICE (T)

### E7.7 Custom Network (a.k.a. BellSouth Custom Network) Service (Cont'd) (T)

#### E7.7.2 Custom Network Service Arrangement I (Cont'd)

##### B. Regulations

1. Custom Network Service Arrangement I is provided under a fixed five year payment period and shall be administered in accordance with the regulations contained in the Channel Services Payment Plan, E2.4.9.A., except as follows:
  - a. The customer has the following options for service following the expiration of the five year payment period:
    - (1) The customer may elect to enter into a new Custom Network Service Arrangement I payment agreement at the rates in effect herein for new customers at the time his contract service expires.
    - (2) The customer may elect that his network service revert back to the generally available analog data and Digital Data Access (*a.k.a. BellSouth SPA DS0 Digital Data*) service rates in E7.5.3 and E7.5.7, respectively, that are in effect at the time his contract service expires. (T)
    - (3) The customer may elect that all Custom Network (*a.k.a. BellSouth Custom Network*) Service be disconnected at the expiration of his contract period. No Termination Liability Charges shall apply. (T)
    - (4) If the customer does not elect (1), (2) or (3) preceding or does not notify the Company of his intentions prior to the time his contract service expires, service shall be continued at the monthly rates currently in effect for month-to-month analog (Voice Grade (*a.k.a. BellSouth SPA DS0 VG*) Data, 4-wire) and digital services (Digital Data Access (*a.k.a. BellSouth SPA DS0 Digital Data*) service) from E7.5.3 and E7.5.7, respectively, until notified otherwise by the customer. (T)
  - b. The disconnect or moves of individual local and/or interoffice channels, hub terminations and/or associated optional features within the Custom Network Service Arrangement I payment period shall be considered as partial disconnects of the network and shall not incur a Termination Liability Charge. A Termination Liability Charge shall apply only for the complete disconnect of all service within Custom Network Service Arrangement I, and shall be calculated as follows:
    - If the aggregate count of analog and/or digital local channels is 1000 or greater at the time of disconnect, the Termination Liability Charge shall be equal to the appropriate monthly rate times the number of months remaining in the Custom Network Service Arrangement I payment period, times the quantities of service in-place at the time of disconnect.
    - If the aggregate count of analog and/or digital local channels is less than 1000 at the time of disconnect, the Termination Liability Charge shall be equal to the appropriate monthly rate times the number of months remaining in the Custom Network Service Arrangement I payment period times the quantities of service in-place at the time of disconnect, plus the monthly rate for a 9.6 Kbps digital local channel times the number of months remaining in the Custom Network Service Arrangement I payment period times the difference between the actual aggregate count of analog and/or digital local channels and the 1000 local channel minimum (as described in 2. following).
2. The minimum initial size for a data network under Custom Network Service Arrangement I shall be an aggregate of not less than 1000 local channels of 4-wire analog data service and/or Digital Data Access (*a.k.a. BellSouth SPA DS0 Digital Data*) service located in the South Central Bell serving area in Tennessee with at least fifty percent being initially of the analog type. (T)
 

The size of the data network shall remain an aggregated minimum of 1000 analog and/or digital local channels for the five year payment period. The network size shall be reviewed annually on the anniversary date of the signing of the payment agreement for Custom Network Service Arrangement I. The purpose of each annual review is to determine if the data network minimum size is being maintained and to make any billing adjustments if the size is below the stated minimum.

  - a. If the aggregate count of analog and/or digital local channels is 1000 or greater on the anniversary date, the network minimum has been met and no billing adjustment is required.



BELLSOUTH  
TELECOMMUNICATIONS  
TENNESSEE

ACCESS SERVICES TARIFF

Third Revised Page 54  
Cancels Second Revised Page 54

ISSUED: February 24, 1997  
BY: Joelle Phillips, President - Tennessee  
Nashville, Tennessee

EFFECTIVE: March 26, 1997

## E7. SPECIAL ACCESS (A.K.A. BELLSOUTH SPA) SERVICE (T)

### E7.7 Custom Network (a.k.a. BellSouth Custom Network) Service (Cont'd) (T)

#### E7.7.2 Custom Network Service Arrangement I (Cont'd)

##### B. Regulations (Cont'd)

##### 2. (Cont'd)

- b. If the aggregate count of analog and/or digital local channels is less than 1000 on the anniversary date, the network minimum has not been met and a one-time charge shall apply to adjust the billing for the prior year. This charge shall be referred to as the annual adjustment charge and is not subject to the Deferred Payment option provided in E2.4.9.A.9.

The calculation to determine this annual adjustment charge takes into account a customer's inward and outward movement that may have occurred for purposes of recovering revenue due for the shortfall in the minimum local channel count.

The annual adjustment charge shall be calculated as follows and shall be imputed as a one-time charge.

- (1) The customer shall pay the equivalent of the monthly rate for a 9.6 Kbps digital local channel provided within their Custom Network Service Arrangement I times the difference between the aggregate local channel count on the anniversary date and the 1000 local channel minimum times 6 months.

3. By the end of the five year payment period ninety percent of the data service in Custom Network Service Arrangement I shall be Digital Data Access (*a.k.a. BellSouth SPA DS0 Digital Data*) service. This ninety percent count shall be based upon the local channels in the Custom Network Service Arrangement I. (T)

- a. A charge shall apply as follows for 4-wire Voice Grade Analog Data (*a.k.a. BellSouth SPA DS0 VG*) services, in excess of the 10 percent allowable, not converted to Digital Data Access (*a.k.a. BellSouth SPA DS0 Digital Data*) service at the expiration of the five year payment period: (T)

The customer shall be charged the difference between the monthly rates contained in Custom Network Service Arrangement I and the monthly rates contained in E7.5.3 of this Tariff for 4-wire Voice Grade Analog Data (*a.k.a. BellSouth SPA DS0 VG*) service times 60 months times the quantities of analog service, in excess of the 10 percent allowable, remaining in-place at the end of the five year payment period. (T)

4. As other speeds of Digital Data Access (*a.k.a. BellSouth SPA DS0 Digital Data*) service become available in E7.5.7 of this Tariff, these new speeds may be added to Custom Network Service Arrangement I. Any new speeds of service added will be available only under the same payment regulations described herein and shall terminate at the same time as the initial payment period for Custom Network Service Arrangement I. (T)

5. Nonrecurring charges specified in C. following do not apply for the conversion of analog data and/or Digital Data Access (*a.k.a. BellSouth SPA DS0 Digital Data*) service in-place at the time the customer establishes Custom Network Service Arrangement I. Any requests for new service to be added to the customer's network or requests to change an in-place analog data service to Digital Data Access (*a.k.a. BellSouth SPA DS0 Digital Data*) service at the time Custom Network Service Arrangement I is established will be subject to the nonrecurring charges specified in C. following. (T)

BELLSOUTH  
TELECOMMUNICATIONS  
TENNESSEE

ACCESS SERVICES TARIFF

Fourth Revised Page 54.1  
Cancels Third Revised Page 54.1

ISSUED: February 24, 1997  
BY: Joelle Phillips, President - Tennessee  
Nashville, Tennessee

EFFECTIVE: March 26, 1997

**E7. SPECIAL ACCESS (A.K.A. BELLSOUTH SPA) SERVICE** (T)

**E7.7 Custom Network (a.k.a. BellSouth Custom Network) Service (Cont'd)** (T)

**E7.7.2 Custom Network Service Arrangement I (Cont'd)**

C. Rates and Charges

1. Voice Grade (a.k.a. BellSouth SPA DS0 VG) Data, Four Wire Service<sup>1</sup> (T)

a. Local Channel

- (1) Per Point of Termination

	Monthly Rate	Nonrecurring Charge First Service Installed	Additional Service Installed	USOC
(a) Each	\$47.50	\$270.00	\$130.00	T6E4X

b. Interoffice Channel

- (1) 0 miles

	Monthly Rate	Nonrecurring Charge	USOC
(a) Per channel	\$-	\$-	1L5XX
(b) Each mile or fraction thereof	-	-	1L5XX

- (2) 1 - 8 miles

(a) Per channel	30.00	96.00	1L5XX
(b) Each mile or fraction thereof	1.95	-	1L5XX

- (3) 9 - 25 miles

(a) Per channel	30.00	96.00	1L5XX
(b) Each mile or fraction thereof	1.90	-	1L5XX

- (4) Over 25 miles

(a) Per channel	30.00	96.00	1L5XX
(b) Each mile or fraction thereof	1.85	-	1L5XX

c. Optional Feature

- (1) Data Bridging, Four Wire

(a) Per port	20.00	38.00	BCND4
--------------	-------	-------	-------

2. Digital Data Access (a.k.a. BellSouth SPA DS0 Digital Data) Service<sup>1</sup> (T)

a. Local Channel

- (1) Per Point of Termination

	Monthly Rate	Nonrecurring Charge First Service Installed	Additional Service Installed	USOC
(a) 2.4 Kbps	\$45.00	\$330.00	\$115.00	T6ECS
(b) 4.8 Kbps	45.00	330.00	115.00	T6ECS
(c) 9.6 Kbps	45.00	330.00	115.00	T6ECS
(d) 19.2 Kbps	45.00	330.00	115.00	T6ECS
(e) 56.0 Kbps	55.00	330.00	115.00	T6ECS
(f) 64.0 Kbps	55.00	330.00	115.00	T6ECS

Note 1: The monthly rates shown are for the fixed five year payment period.

BELLSOUTH  
TELECOMMUNICATIONS  
TENNESSEE

ACCESS SERVICES TARIFF

Fourth Revised Page 54.2  
Cancels Third Revised Page 54.2

ISSUED: February 24, 1997  
BY: Joelle Phillips, President - Tennessee  
Nashville, Tennessee

EFFECTIVE: March 26, 1997

**E7. SPECIAL ACCESS (A.K.A. BELLSOUTH SPA) SERVICE** (T)

**E7.7 Custom Network(a.k.a. BellSouth Custom Network) Service (Cont'd)** (T)

**E7.7.2 Custom Network Service Arrangement I (Cont'd)**

C. Rates and Charges (Cont'd)

2. Digital Data Access (a.k.a. BellSouth SPA DS0 Digital Data) Service<sup>1</sup> (Cont'd) (T)

b. Hub Termination

(1) Per Local Channel

	Monthly Rate	Nonrecurring Charge		USOC
		First Service Installed	Additional Service Installed	
(a) 2.4 Kbps	\$9.00	\$61.00	\$54.00	TUTA4
(b) 4.8 Kbps	9.00	61.00	54.00	TUTB4
(c) 9.6 Kbps	9.00	61.00	54.00	TUTC4
(d) 19.2 Kbps	9.00	61.00	54.00	TUTE4
(e) 56.0 Kbps	24.00	61.00	54.00	TUTD4
(f) 64.0 Kbps	24.00	61.00	54.00	TUTF4

c. Interoffice Channel, 0 miles

(1) Per channel

	Monthly Rate	Nonrecurring Charge	USOC
(a) 2.4, 4.8, 9.6 and 19.2 Kbps	\$-	\$-	1L5XX
(b) 56.0 and 64.0 Kbps	-	-	1L5XX
(2) Each mile or fraction thereof			
(a) 2.4, 4.8, 9.6 and 19.2 Kbps	-	-	1L5XX
(b) 56.0 and 64.0 Kbps	-	-	1L5XX

d. Interoffice Channel, 1 - 8 miles

(1) Per channel

(a) 2.4, 4.8, 9.6, and 19.2 Kbps	18.00	39.00	1L5XX
(b) 56.0 and 64.0 Kbps	32.00	39.00	1L5XX
(2) Each mile or fraction thereof			
(a) 2.4, 4.8, 9.6 and 19.2 Kbps	1.60	-	1L5XX
(b) 56.0 and 64.0 Kbps	3.20	-	1L5XX

e. Interoffice Channel, 9 - 25 miles

(1) Per channel

(a) 2.4, 4.8, 9.6 and 19.2 Kbps	18.00	39.00	1L5XX
(b) 56.0 and 64.0 Kbps	32.00	39.00	1L5XX
(2) Each mile or fraction thereof			
(a) 2.4, 4.8, 9.6 and 19.2 Kbps	1.60	-	1L5XX
(b) 56.0 and 64.0 Kbps	3.20	-	1L5XX

Note 1: The monthly rates shown are for the fixed five year payment period.

BELLSOUTH  
 TELECOMMUNICATIONS  
 TENNESSEE

ACCESS SERVICES TARIFF

Fourth Revised Page 54.3  
 Cancels Third Revised Page 54.3

ISSUED: February 24, 1997  
 BY: Joelle Phillips, President - Tennessee  
 Nashville, Tennessee

EFFECTIVE: March 26, 1997

**E7. SPECIAL ACCESS (A.K.A. BELLSOUTH SPA) SERVICE** (T)

**E7.7 Custom Network (a.k.a. BellSouth Custom Network) Service (Cont'd)** (T)

**E7.7.2 Custom Network Service Arrangement I (Cont'd)**

C. Rates and Charges (Cont'd)

2. Digital Data Access (*a.k.a. BellSouth SPA DS0 Digital Data*) Service<sup>1</sup> (Cont'd) (T)

f. Interoffice Channel, over 25 miles

(1) Per channel

	Monthly Rate	Nonrecurring Charge	USOC
(a) 2.4, 4.8, 9.6 and 19.2 Kbps	\$18.00	\$39.00	1L5XX
(b) 56.0 and 64.0 Kbps	32.00	39.00	1L5XX
(2) Each mile or fraction thereof			
(a) 2.4, 4.8, 9.6 and 19.2 Kbps	1.60	-	1L5XX
(b) 56.0 and 64.0 Kbps	3.20	-	1L5XX

g. Optional Features

(1) Bridging

(a) Per port (2.4, 4.8, 9.6, 19.2, 56.0 Kbps)	10.00	25.00	BCNDA
---	-------	-------	-------

Note 1: The monthly rates shown are for the fixed five year payment period.

BELLSOUTH  
TELECOMMUNICATIONS  
TENNESSEE

ACCESS SERVICES TARIFF

Third Revised Page 55  
Cancels Second Revised Page 55

ISSUED: February 24, 1997  
BY: Joelle Phillips, President - Tennessee  
Nashville, Tennessee

EFFECTIVE: March 26, 1997

## E7. SPECIAL ACCESS (A.K.A. BELLSOUTH SPA) SERVICE (T)

### E7.7 Custom Network (a.k.a. BellSouth Custom Network) Service (Cont'd) (T)

#### E7.7.3 Custom Network Service Arrangement II

##### A. General

Custom Network Service Arrangement II is provided to furnish a very large data network of Special Access Voice Grade Data (*a.k.a. BellSouth SPA DS0 VG*) service (may be referred to as analog data or 4-wire analog data service) and Digital Data Access (*a.k.a. BellSouth SPA DS0 Digital Data*) service (may be referred to as digital data or 4-wire digital data service). (T)

The analog data service and digital data service provided in Custom Network Service Arrangement II will be subject to the regulations in this Tariff which apply to Special Access Voice Grade Data (*a.k.a. BellSouth SPA DS0 VG*) and Digital Data Access (*a.k.a. BellSouth SPA DS0 Digital Data*) service from Section E7., except where stated otherwise herein. (T)

Customers subscribing to Custom Network Service Arrangement I may request to subscribe to Custom Network Service Arrangement II prior to the expiration of the Custom Network Service Arrangement I service period agreement. No termination liability charges or service penalty charges from Custom Network Service Arrangement I shall apply for such changes; however, no service credit will be given for the former contractual period.

##### B. Regulations

1. Custom Network Service Arrangement II is provided under a ten year payment period agreement administered in accordance with the regulations contained in the Channel Services Payment Plan (CSPP), E2.4.9.A., except as follows herein E7.7.3.B.
2. Custom Network Service Arrangement II is provided under a ten year payment period agreement with a mandatory minimum service period of five years required. After completion of the fifth year in this payment period agreement, the customer may elect to continue this payment period agreement for another five year period (not to exceed a total payment period of ten years), or the customer may elect one of the service options stated following.

The customer has the following options for service following the expiration of his Custom Network Service Arrangement II payment period:

- a. The customer may elect to enter into a new Custom Network Service Arrangement II payment agreement at the rates in effect herein for new customers at the time his contract service expires.
- b. The customer may elect that his network service revert back to the generally available services offered by this Company (e.g., Special Access Voice Grade Data (*a.k.a. BellSouth SPA DS0 VG*) and Digital Data Access (*a.k.a. BellSouth SPA DS0 Digital Data*) service from Section B7.) at the rates that are in effect at the time his contract service expires. (T)
- c. The customer may elect that all services provided under this Custom Network Service Arrangement II be disconnected at the expiration of his contract period. No Termination Liability Charges shall apply.
- d. If the customer does not elect a., b. or c. preceding or does not notify the Company of his intentions prior to the time his contract services expire, service shall be continued at the monthly rates currently in effect for these services on a month-to-month basis (e.g., Special Access Voice Grade Data (*a.k.a. BellSouth SPA DS0 VG*) and Digital Data Access (*a.k.a. BellSouth SPA DS0 Digital Data*) service from Section E7.) until the Company is notified otherwise by the customer. (T)
3. The minimum initial size for a data network under Custom Network Service Arrangement II shall be an aggregate of not less than 2000 local channels of 4-wire analog data service and/or Digital Data Access (*a.k.a. BellSouth SPA DS0 Digital Data*) service located in the South Central Bell serving area in Tennessee. By the end of the first year the customer's network must contain a minimum of 2000 digital data local channels. (T)

The network minimum size of 2000 digital data local channels shall apply for the entire payment period. The network size shall be reviewed annually on the anniversary date of the signing of the payment agreement for Custom Network Service Arrangement II. The purpose of each annual review is to determine if the appropriate digital data network minimum size has been met and is being maintained and to make any billing adjustment if the size is below the stated minimum of 2000 digital data local channels. These charges shall be referred to as an annual adjustment charge and are not subject to the Deferred Payment option provided in E2.4.9.A.9.

BELLSOUTH  
TELECOMMUNICATIONS  
TENNESSEE

ACCESS SERVICES TARIFF

Third Revised Page 56  
Cancels Second Revised Page 56

ISSUED: February 24, 1997  
BY: Joelle Phillips, President - Tennessee  
Nashville, Tennessee

EFFECTIVE: March 26, 1997

## **E7. SPECIAL ACCESS (A.K.A. BELLSOUTH SPA) SERVICE**

(T)

### **E7.7 Custom Network (a.k.a. BellSouth Custom Network) Service (Cont'd)**

(T)

#### **E7.7.3 Custom Network Service Arrangement II (Cont'd)**

##### **B. Regulations (Cont'd)**

##### **3. (Cont'd)**

a. The calculation to determine an annual adjustment charge takes into account a customer's inward and outward movement that may have occurred for purposes of recovering revenue due for the shortfall in the specified network minimum local channel count set forth in this Custom Network Service Arrangement II.

(1) The annual adjustment charge which applies when the specific network minimum of 2000 digital data local channels has not been met shall be calculated as follows and be imputed as a one-time charge:

The customer shall pay the equivalent of the monthly rate for a 9.6 Kbps digital local channel, provided within their Custom Network Service Arrangement II, times the difference between the 2000 minimum and the actual count of digital data local channels, times 6 months.

4. The disconnect or moves of individual local and/or interoffice channels, hub terminations and/or associated optional features with the Custom Network Service Arrangement II payment period shall be considered as partial disconnects of the network and shall not incur a Termination Liability Charge. A Termination Liability Charge shall apply only for the complete disconnect of all service within Custom Network Service Arrangement II (except as specified in 5. following) and shall be calculated as follows:

a. If the count of digital data local channels is 2000 or greater at the time of disconnect, the Termination Liability Charge shall be equal to the appropriate monthly rate, times the number of months remaining in the Custom Network Service Arrangement II payment period, times the actual quantities of service in-place at the time of disconnect.

BELLSOUTH  
TELECOMMUNICATIONS  
TENNESSEE

ACCESS SERVICES TARIFF

Third Revised Page 57  
Cancels Second Revised Page 57

ISSUED: February 24, 1997  
BY: Joelle Phillips, President - Tennessee  
Nashville, Tennessee

EFFECTIVE: March 26, 1997

**E7. SPECIAL ACCESS (A.K.A. BELLSOUTH SPA) SERVICE** (T)

**E7.7 Custom Network (a.k.a. BellSouth Custom Network) Service (Cont'd)** (T)

**E7.7.3 Custom Network Service Arrangement II (Cont'd)**

B. Regulations (Cont'd)

4. (Cont'd)

b. If the count of digital data local channels is less than 2000 at the time of disconnect, the Termination Liability Charge shall be equal to 1) the appropriate monthly rate, times the number of months remaining in the Custom Network Service Arrangement II payment period, times the quantities of service in-place at the time of disconnect, plus 2) the monthly rate for a 9.6 Kbps digital local channel, times the number of months remaining in the Custom Network Service Arrangement II payment period, times the difference between the actual count of digital data local channels and the 2000 local digital data channel minimum.

5. A Termination Liability Charge as specified in 4. preceding shall apply for the total disconnect of Custom Network Service Arrangement II unless both of the following conditions are met: 1) the disconnect occurs after Custom Network Service Arrangement II has been in-place for a minimum of twenty-four months and 2) if the customer elects another Custom Network Service Arrangement for a period of time equal to or greater than the amount of time remaining in his Custom Network Service Arrangement II payment period. If these conditions are met, no Termination Liability Charge shall apply.

6. As developed by the Company other new technologies capable of supporting digital data transport may be added to this Custom Network Service Arrangement II tariff. Such data services shall qualify on a per local channel or access line basis toward the 2000 minimum digital data local channel count required for Custom Network Service Arrangement II specified in 3. preceding. Any new services added will be available under the same payment regulations described herein and shall terminate at the same time as the initial payment period agreement established for each customer's Custom Network Service Arrangement II.

7. Nonrecurring charges specified in C. following do not apply for the conversion of analog data and digital data service in-place at the time the customer establishes Custom Network Service Arrangement II. Termination Liability Charges shall not apply for the conversion of in-place analog data and digital data service that was being provided under another Custom Network Service Arrangement or other CSPP arrangement to the services included in Custom Network Service Arrangement II. Requests for new service to be added to the customer's network will be subject to the nonrecurring charges specified in C. following.

Full digital data nonrecurring charges apply for analog data service requested to be converted to digital data service, except as follows:

a. No digital data service nonrecurring charges shall apply for analog data service conversions to digital data service ordered during the first twelve months following the establishment of each customer's Custom Network Service Arrangement II; specifically, the digital data service nonrecurring charges will not apply when the service order application date requesting the analog data service conversion falls within this first twelve month period and the digital service is to be provided within the Company's standard installation interval.

C. Rates and Charges

1. Voice Grade (*a.k.a. BellSouth SPA DS0 VG*) Data, Four Wire Service (T)

a. Local Channel

(1) Per Point of Termination

		<b>Nonrecurring Charge</b>			
		<b>Monthly</b>	<b>First</b>	<b>Additional</b>	
		<b>Rate</b>	<b>Service</b>	<b>Service</b>	<b>USOC</b>
			<b>Installed</b>	<b>Installed</b>	
(a)	Each	<b>\$42.50</b>	<b>\$380.00</b>	<b>\$110.00</b>	<b>T6E4X</b>

BELLSOUTH  
TELECOMMUNICATIONS  
TENNESSEE

ACCESS SERVICES TARIFF

Third Revised Page 58  
Cancels Second Revised Page 58

ISSUED: February 24, 1997  
BY: Joelle Phillips, President - Tennessee  
Nashville, Tennessee

EFFECTIVE: March 26, 1997

**E7. SPECIAL ACCESS (A.K.A. BELLSOUTH SPA) SERVICE** (T)

**E7.7 Custom Network (a.k.a. BellSouth Custom Network) Service (Cont'd)** (T)

**E7.7.3 Custom Network Service Arrangement II (Cont'd)**

C. Rates and Charges (Cont'd)

1. Voice Grade (a.k.a. BellSouth SPA DS0 VG) Data, Four Wire Service (Cont'd) (T)

b. Interoffice Channel

(1) 0 miles

	Monthly Rate	Nonrecurring Charge	USOC
(a) Per channel	\$-	\$-	1L5XX
(b) Each mile or fraction thereof	-	-	1L5XX

(2) 1 - 8 miles

(a) Per channel	27.20	115.00	1L5XX
(b) Each mile or fraction thereof	1.65	-	1L5XX

(3) 9 - 25 miles

(a) Per channel	27.20	115.00	1L5XX
(b) Each mile or fraction thereof	1.65	-	1L5XX

(4) Over 25 miles

(a) Per channel	27.20	115.00	1L5XX
(b) Each mile or fraction thereof	1.65	-	1L5XX

c. Optional Feature

(1) Data Bridging, Four Wire

(a) Per port	17.00	56.00	BCND4
--------------	-------	-------	-------

2. Digital Data Access (a.k.a. BellSouth SPA DS0 Digital Data) Service (T)

a. Local Channel

(1) Per Point of Termination

	Monthly Rate	Nonrecurring Charge		USOC
		First Service Installed	Additional Service Installed	
(a) 2.4 Kbps	\$45.00	\$520.00	\$315.00	T6ECS
(b) 4.8 Kbps	45.00	520.00	315.00	T6ECS
(c) 9.6 Kbps	45.00	520.00	315.00	T6ECS
(d) 19.2 Kbps	45.00	520.00	315.00	T6ECS
(e) 56.0 Kbps	50.00	560.00	355.00	T6ECS
(f) 64.0 Kbps	50.00	605.00	400.00	T6ECS

b. Hub Termination

(1) Per Local Channel

(a) 2.4 Kbps	8.00	28.00	25.00	TUTA4
(b) 4.8 Kbps	8.00	28.00	25.00	TUTB4
(c) 9.6 Kbps	8.00	28.00	25.00	TUTC4
(d) 19.2 Kbps	8.00	28.00	25.00	TUTE4
(e) 56.0 Kbps	22.00	28.00	25.00	TUTD4
(f) 64.0 Kbps	22.00	28.00	25.00	TUTF4



BELLSOUTH  
TELECOMMUNICATIONS  
TENNESSEE

ACCESS SERVICES TARIFF

Third Revised Page 59  
Cancels Second Revised Page 59

ISSUED: February 24, 1997  
BY: Joelle Phillips, President - Tennessee  
Nashville, Tennessee

EFFECTIVE: March 26, 1997

**E7. SPECIAL ACCESS (A.K.A. BELLSOUTH SPA) SERVICE** (T)

**E7.7 Custom Network (a.k.a. BellSouth Custom Network) Service (Cont'd)** (T)

**E7.7.3 Custom Network Service Arrangement II (Cont'd)**

C. Rates and Charges (Cont'd)

2. Digital Data Access (a.k.a. BellSouth SPA DS0 Digital Data) Service (Cont'd) (T)

c. Interoffice Channel, 0 miles

(1) Per channel

- (a) 2.4, 4.8, 9.6 and 19.2 Kbps
- (b) 56.0 and 64.0 Kbps

(2) Each mile or fraction thereof

- (a) 2.4, 4.8, 9.6 and 19.2 Kbps
- (b) 56.0 and 64.0 Kbps

d. Interoffice Channel, 1 - 8 miles

(1) Per channel

- (a) 2.4, 4.8, 9.6, and 19.2 Kbps
- (b) 56.0 and 64.0 Kbps

(2) Each mile or fraction thereof

- (a) 2.4, 4.8, 9.6 and 19.2 Kbps
- (b) 56.0 and 64.0 Kbps

e. Interoffice Channel, 9 - 25 miles

(1) Per channel

- (a) 2.4, 4.8, 9.6 and 19.2 Kbps
- (b) 56.0 and 64.0 Kbps

(2) Each mile or fraction thereof

- (a) 2.4, 4.8, 9.6 and 19.2 Kbps
- (b) 56.0 and 64.0 Kbps

f. Interoffice Channel, over 25 miles

(1) Per channel

- (a) 2.4, 4.8, 9.6 and 19.2 Kbps
- (b) 56.0 and 64.0 Kbps

(2) Each mile or fraction thereof

- (a) 2.4, 4.8, 9.6 and 19.2 Kbps
- (b) 56.0 and 64.0 Kbps

g. Optional Features I

(1) Bridging

- (a) Per port (2.4, 4.8, 9.6, 19.2, 56.0 Kbps)

Note 1: This option may not be available in all service locations.

	Monthly Rate	Nonrecurring Charge	USOC
(a) 2.4, 4.8, 9.6 and 19.2 Kbps	\$-	\$-	1L5XX
(b) 56.0 and 64.0 Kbps	-	-	1L5XX
(2) Each mile or fraction thereof			
(a) 2.4, 4.8, 9.6 and 19.2 Kbps	-	-	1L5XX
(b) 56.0 and 64.0 Kbps	-	-	1L5XX
d. Interoffice Channel, 1 - 8 miles			
(1) Per channel			
(a) 2.4, 4.8, 9.6, and 19.2 Kbps	16.00	62.00	1L5XX
(b) 56.0 and 64.0 Kbps	29.00	62.00	1L5XX
(2) Each mile or fraction thereof			
(a) 2.4, 4.8, 9.6 and 19.2 Kbps	1.00	-	1L5XX
(b) 56.0 and 64.0 Kbps	2.00	-	1L5XX
e. Interoffice Channel, 9 - 25 miles			
(1) Per channel			
(a) 2.4, 4.8, 9.6 and 19.2 Kbps	16.00	62.00	1L5XX
(b) 56.0 and 64.0 Kbps	29.00	62.00	1L5XX
(2) Each mile or fraction thereof			
(a) 2.4, 4.8, 9.6 and 19.2 Kbps	1.00	-	1L5XX
(b) 56.0 and 64.0 Kbps	2.00	-	1L5XX
f. Interoffice Channel, over 25 miles			
(1) Per channel			
(a) 2.4, 4.8, 9.6 and 19.2 Kbps	16.00	62.00	1L5XX
(b) 56.0 and 64.0 Kbps	29.00	62.00	1L5XX
(2) Each mile or fraction thereof			
(a) 2.4, 4.8, 9.6 and 19.2 Kbps	1.00	-	1L5XX
(b) 56.0 and 64.0 Kbps	2.00	-	1L5XX
g. Optional Features I			
(1) Bridging			
(a) Per port (2.4, 4.8, 9.6, 19.2, 56.0 Kbps)	10.00	15.00	BCNDA

BELLSOUTH  
TELECOMMUNICATIONS  
TENNESSEE

## ACCESS SERVICES TARIFF

Third Revised Page 60  
Cancels Second Revised Page 60

ISSUED: February 24, 1997  
BY: Joelle Phillips, President - Tennessee  
Nashville, Tennessee

EFFECTIVE: March 26, 1997

**E7. SPECIAL ACCESS (A.K.A. BELLSOUTH SPA) SERVICE**

(T)

## CANCELLATION PAGE

The following pages have been cancelled. (when utilizing these pages the revision level should be raised one level.)

Page	Revision	Page	Revision
		90	2
		91	1
		92	1
		93	1
		94	1
		95	1
		96	1
		97	1
		98	1
		99	1
		100	1
		101	1
		102	1
		103	1
		104	1
		105	1
		106	1
		107	1
		108	1
		109	1
		110	1
		112	1
		113	1
		113	1
		114	1
		115	1
		116	1
		117	1
		118	1
		119	1
		120	1
		121	1
		122	2
		122.1	1
		123	1
		124	1
		125	1
		126	1
		127	1
		128	1
		129	1
		130	1
61	1		
62	1		
63	1		
64	1		
65	1		
66	1		
67	1		
68	1		
69	1		
70	1		
71	1		
72	1		
73	1		
74	1		
75	1		
76	1		
77	1		
78	1		
79	1		
80	1		
81	1		
81.1	2		
82	1		
82.1	2		
83	1		
83.1	2		
84	1		
84.1	2		
85	1		
86	1		
87	1		
88	1		
89	1		

BELLSOUTH  
TELECOMMUNICATIONS  
TENNESSEE

ACCESS SERVICES TARIFF

First Revised Page 61  
Cancels Original Page 61

ISSUED: February 15, 1989  
BY: Joelle Phillips, President - Tennessee  
Nashville, Tennessee

EFFECTIVE: July 2, 1990

## **E7. SPECIAL ACCESS SERVICE**

Reserved For Future Use

BELLSOUTH  
TELECOMMUNICATIONS  
TENNESSEE

ACCESS SERVICES TARIFF

First Revised Page 62  
Cancels Original Page 62

ISSUED: February 15, 1989  
BY: Joelle Phillips, President - Tennessee  
Nashville, Tennessee

EFFECTIVE: July 2, 1990

## **E7. SPECIAL ACCESS SERVICE**

Reserved For Future Use

BELLSOUTH  
TELECOMMUNICATIONS  
TENNESSEE

ACCESS SERVICES TARIFF

First Revised Page 63  
Cancels Original Page 63

ISSUED: February 15, 1989  
BY: Joelle Phillips, President - Tennessee  
Nashville, Tennessee

EFFECTIVE: July 2, 1990

## **E7. SPECIAL ACCESS SERVICE**

Reserved For Future Use

BELLSOUTH  
TELECOMMUNICATIONS  
TENNESSEE

ACCESS SERVICES TARIFF

First Revised Page 64  
Cancels Original Page 64

ISSUED: February 15, 1989  
BY: Joelle Phillips, President - Tennessee  
Nashville, Tennessee

EFFECTIVE: July 2, 1990

## **E7. SPECIAL ACCESS SERVICE**

Reserved For Future Use

BELLSOUTH  
TELECOMMUNICATIONS  
TENNESSEE

ACCESS SERVICES TARIFF

First Revised Page 65  
Cancels Original Page 65

ISSUED: February 15, 1989  
BY: Joelle Phillips, President - Tennessee  
Nashville, Tennessee

EFFECTIVE: July 2, 1990

## **E7. SPECIAL ACCESS SERVICE**

Reserved For Future Use

BELLSOUTH  
TELECOMMUNICATIONS  
TENNESSEE

ACCESS SERVICES TARIFF

First Revised Page 66  
Cancels Original Page 66

ISSUED: February 15, 1989  
BY: Joelle Phillips, President - Tennessee  
Nashville, Tennessee

EFFECTIVE: July 2, 1990

## **E7. SPECIAL ACCESS SERVICE**

Reserved For Future Use



BELLSOUTH  
TELECOMMUNICATIONS  
TENNESSEE

ACCESS SERVICES TARIFF

First Revised Page 67  
Cancels Original Page 67

ISSUED: February 15, 1989

EFFECTIVE: July 2, 1990

BY: Joelle Phillips, President - Tennessee  
Nashville, Tennessee

## **E7. SPECIAL ACCESS SERVICE**

Reserved For Future Use

BELLSOUTH  
TELECOMMUNICATIONS  
TENNESSEE

ACCESS SERVICES TARIFF

First Revised Page 68  
Cancels Original Page 68

ISSUED: February 15, 1989  
BY: Joelle Phillips, President - Tennessee  
Nashville, Tennessee

EFFECTIVE: July 2, 1990

## **E7. SPECIAL ACCESS SERVICE**

Reserved For Future Use

BELLSOUTH  
TELECOMMUNICATIONS  
TENNESSEE

ACCESS SERVICES TARIFF

First Revised Page 69  
Cancels Original Page 69

ISSUED: February 15, 1989  
BY: Joelle Phillips, President - Tennessee  
Nashville, Tennessee

EFFECTIVE: July 2, 1990

## **E7. SPECIAL ACCESS SERVICE**

Reserved For Future Use

BELLSOUTH  
TELECOMMUNICATIONS  
TENNESSEE

ACCESS SERVICES TARIFF

First Revised Page 70  
Cancels Original Page 70

ISSUED: February 15, 1989  
BY: Joelle Phillips, President - Tennessee  
Nashville, Tennessee

EFFECTIVE: July 2, 1990

## **E7. SPECIAL ACCESS SERVICE**

Reserved For Future Use

BELLSOUTH  
TELECOMMUNICATIONS  
TENNESSEE

ACCESS SERVICES TARIFF

First Revised Page 71  
Cancels Original Page 71

ISSUED: February 15, 1989  
BY: Joelle Phillips, President - Tennessee  
Nashville, Tennessee

EFFECTIVE: July 2, 1990

## **E7. SPECIAL ACCESS SERVICE**

Reserved For Future Use

BELLSOUTH  
TELECOMMUNICATIONS  
TENNESSEE

ACCESS SERVICES TARIFF

First Revised Page 72  
Cancels Original Page 72

ISSUED: February 15, 1989  
BY: Joelle Phillips, President - Tennessee  
Nashville, Tennessee

EFFECTIVE: July 2, 1990

## **E7. SPECIAL ACCESS SERVICE**

Reserved For Future Use

BELLSOUTH  
TELECOMMUNICATIONS  
TENNESSEE

ACCESS SERVICES TARIFF

First Revised Page 73  
Cancels Original Page 73

ISSUED: February 15, 1989

EFFECTIVE: July 2, 1990

BY: Joelle Phillips, President - Tennessee  
Nashville, Tennessee

## **E7. SPECIAL ACCESS SERVICE**

Reserved For Future Use

BELLSOUTH  
TELECOMMUNICATIONS  
TENNESSEE

ACCESS SERVICES TARIFF

First Revised Page 74  
Cancels Original Page 74

ISSUED: February 15, 1989  
BY: Joelle Phillips, President - Tennessee  
Nashville, Tennessee

EFFECTIVE: July 2, 1990

## **E7. SPECIAL ACCESS SERVICE**

Reserved For Future Use



BELLSOUTH  
TELECOMMUNICATIONS  
TENNESSEE

ACCESS SERVICES TARIFF

First Revised Page 75  
Cancels Original Page 75

ISSUED: February 15, 1989  
BY: Joelle Phillips, President - Tennessee  
Nashville, Tennessee

EFFECTIVE: July 2, 1990

## **E7. SPECIAL ACCESS SERVICE**

Reserved For Future Use

BELLSOUTH  
TELECOMMUNICATIONS  
TENNESSEE

ACCESS SERVICES TARIFF

First Revised Page 76  
Cancels Original Page 76

ISSUED: February 15, 1989  
BY: Joelle Phillips, President - Tennessee  
Nashville, Tennessee

EFFECTIVE: July 2, 1990

## **E7. SPECIAL ACCESS SERVICE**

Reserved For Future Use

BELLSOUTH  
TELECOMMUNICATIONS  
TENNESSEE

ACCESS SERVICES TARIFF

First Revised Page 77  
Cancels Original Page 77

ISSUED: February 15, 1989  
BY: Joelle Phillips, President - Tennessee  
Nashville, Tennessee

EFFECTIVE: July 2, 1990

## **E7. SPECIAL ACCESS SERVICE**

Reserved For Future Use

BELLSOUTH  
TELECOMMUNICATIONS  
TENNESSEE

ACCESS SERVICES TARIFF

First Revised Page 78  
Cancels Original Page 78

ISSUED: February 15, 1989  
BY: Joelle Phillips, President - Tennessee  
Nashville, Tennessee

EFFECTIVE: July 2, 1990

## **E7. SPECIAL ACCESS SERVICE**

Reserved For Future Use

BELLSOUTH  
TELECOMMUNICATIONS  
TENNESSEE

ACCESS SERVICES TARIFF

First Revised Page 79  
Cancels Original Page 79

ISSUED: February 15, 1989  
BY: Joelle Phillips, President - Tennessee  
Nashville, Tennessee

EFFECTIVE: July 2, 1990

## **E7. SPECIAL ACCESS SERVICE**

Reserved For Future Use

BELLSOUTH  
TELECOMMUNICATIONS  
TENNESSEE

ACCESS SERVICES TARIFF

First Revised Page 80  
Cancels Original Page 80

ISSUED: February 15, 1989  
BY: Joelle Phillips, President - Tennessee  
Nashville, Tennessee

EFFECTIVE: July 2, 1990

## **E7. SPECIAL ACCESS SERVICE**

Reserved For Future Use

BELLSOUTH  
TELECOMMUNICATIONS  
TENNESSEE

ACCESS SERVICES TARIFF

Second Revised Page 81  
Cancels First Revised Page 81

ISSUED: February 15, 1989  
BY: Joelle Phillips, President - Tennessee  
Nashville, Tennessee

EFFECTIVE: July 2, 1990

**E7. SPECIAL ACCESS SERVICE**

Reserved For Future Use

BELLSOUTH  
TELECOMMUNICATIONS  
TENNESSEE

ACCESS SERVICES TARIFF

First Revised Page 81.1  
Cancels Original Page 81.1

ISSUED: February 15, 1989  
BY: Joelle Phillips, President - Tennessee  
Nashville, Tennessee

EFFECTIVE: July 2, 1990

**E7. SPECIAL ACCESS SERVICE**

Reserved For Future Use



BELLSOUTH  
TELECOMMUNICATIONS  
TENNESSEE

ACCESS SERVICES TARIFF

Second Revised Page 82  
Cancels First Revised Page 82

ISSUED: February 15, 1989  
BY: Joelle Phillips, President - Tennessee  
Nashville, Tennessee

EFFECTIVE: July 2, 1990

## **E7. SPECIAL ACCESS SERVICE**

Reserved For Future Use

BELLSOUTH  
TELECOMMUNICATIONS  
TENNESSEE

ACCESS SERVICES TARIFF

First Revised Page 82.1  
Cancels Original Page 82.1

ISSUED: February 15, 1989  
BY: Joelle Phillips, President - Tennessee  
Nashville, Tennessee

EFFECTIVE: July 2, 1990

**E7. SPECIAL ACCESS SERVICE**

Reserved For Future Use

BELLSOUTH  
TELECOMMUNICATIONS  
TENNESSEE

ACCESS SERVICES TARIFF

Second Revised Page 83  
Cancels First Revised Page 83

ISSUED: February 15, 1989  
BY: Joelle Phillips, President - Tennessee  
Nashville, Tennessee

EFFECTIVE: July 2, 1990

## **E7. SPECIAL ACCESS SERVICE**

Reserved For Future Use

BELLSOUTH  
TELECOMMUNICATIONS  
TENNESSEE

ACCESS SERVICES TARIFF

First Revised Page 83.1  
Cancels Original Page 83.1

ISSUED: February 15, 1989  
BY: Joelle Phillips, President - Tennessee  
Nashville, Tennessee

EFFECTIVE: July 2, 1990

## **E7. SPECIAL ACCESS SERVICE**

Reserved For Future Use

BELLSOUTH  
TELECOMMUNICATIONS  
TENNESSEE

ACCESS SERVICES TARIFF

Second Revised Page 84  
Cancels First Revised Page 84

ISSUED: February 15, 1989  
BY: Joelle Phillips, President - Tennessee  
Nashville, Tennessee

EFFECTIVE: July 2, 1990

## **E7. SPECIAL ACCESS SERVICE**

Reserved For Future Use

BELLSOUTH  
TELECOMMUNICATIONS  
TENNESSEE

ACCESS SERVICES TARIFF

First Revised Page 84.1  
Cancels Original Page 84.1

ISSUED: February 15, 1989  
BY: Joelle Phillips, President - Tennessee  
Nashville, Tennessee

EFFECTIVE: July 2, 1990

**E7. SPECIAL ACCESS SERVICE**

Reserved For Future Use

BELLSOUTH  
TELECOMMUNICATIONS  
TENNESSEE

ACCESS SERVICES TARIFF

First Revised Page 85  
Cancels Original Page 85

ISSUED: February 15, 1989  
BY: Joelle Phillips, President - Tennessee  
Nashville, Tennessee

EFFECTIVE: July 2, 1990

## **E7. SPECIAL ACCESS SERVICE**

Reserved For Future Use

BELLSOUTH  
TELECOMMUNICATIONS  
TENNESSEE

ACCESS SERVICES TARIFF

First Revised Page 86  
Cancels Original Page 86

ISSUED: February 15, 1989  
BY: Joelle Phillips, President - Tennessee  
Nashville, Tennessee

EFFECTIVE: July 2, 1990

## **E7. SPECIAL ACCESS SERVICE**

Reserved For Future Use



BELLSOUTH  
TELECOMMUNICATIONS  
TENNESSEE

ACCESS SERVICES TARIFF

First Revised Page 87  
Cancels Original Page 87

ISSUED: February 15, 1989

EFFECTIVE: July 2, 1990

BY: Joelle Phillips, President - Tennessee  
Nashville, Tennessee

## **E7. SPECIAL ACCESS SERVICE**

Reserved For Future Use

BELLSOUTH  
TELECOMMUNICATIONS  
TENNESSEE

ACCESS SERVICES TARIFF

First Revised Page 88  
Cancels Original Page 88

ISSUED: February 15, 1989  
BY: Joelle Phillips, President - Tennessee  
Nashville, Tennessee

EFFECTIVE: July 2, 1990

## **E7. SPECIAL ACCESS SERVICE**

Reserved For Future Use

BELLSOUTH  
TELECOMMUNICATIONS  
TENNESSEE

ACCESS SERVICES TARIFF

First Revised Page 89  
Cancels Original Page 89

ISSUED: February 15, 1989  
BY: Joelle Phillips, President - Tennessee  
Nashville, Tennessee

EFFECTIVE: July 2, 1990

## **E7. SPECIAL ACCESS SERVICE**

Reserved For Future Use

BELLSOUTH  
TELECOMMUNICATIONS  
TENNESSEE

ACCESS SERVICES TARIFF

Second Revised Page 90  
Cancels First Revised Page 90

ISSUED: February 15, 1989  
BY: Joelle Phillips, President - Tennessee  
Nashville, Tennessee

EFFECTIVE: July 2, 1990

## **E7. SPECIAL ACCESS SERVICE**

Reserved For Future Use

BELLSOUTH  
TELECOMMUNICATIONS  
TENNESSEE

ACCESS SERVICES TARIFF

First Revised Page 91  
Cancels Original Page 91

ISSUED: February 15, 1989  
BY: Joelle Phillips, President - Tennessee  
Nashville, Tennessee

EFFECTIVE: July 2, 1990

## **E7. SPECIAL ACCESS SERVICE**

Reserved For Future Use

BELLSOUTH  
TELECOMMUNICATIONS  
TENNESSEE

ACCESS SERVICES TARIFF

First Revised Page 92  
Cancels Original Page 92

ISSUED: February 15, 1989  
BY: Joelle Phillips, President - Tennessee  
Nashville, Tennessee

EFFECTIVE: July 2, 1990

## **E7. SPECIAL ACCESS SERVICE**

Reserved For Future Use

BELLSOUTH  
TELECOMMUNICATIONS  
TENNESSEE

ACCESS SERVICES TARIFF

First Revised Page 93  
Cancels Original Page 93

ISSUED: February 15, 1989  
BY: Joelle Phillips, President - Tennessee  
Nashville, Tennessee

EFFECTIVE: July 2, 1990

## **E7. SPECIAL ACCESS SERVICE**

Reserved For Future Use

BELLSOUTH  
TELECOMMUNICATIONS  
TENNESSEE

ACCESS SERVICES TARIFF

First Revised Page 94  
Cancels Original Page 94

ISSUED: February 15, 1989  
BY: Joelle Phillips, President - Tennessee  
Nashville, Tennessee

EFFECTIVE: July 2, 1990

## **E7. SPECIAL ACCESS SERVICE**

Reserved For Future Use



BELLSOUTH  
TELECOMMUNICATIONS  
TENNESSEE

ACCESS SERVICES TARIFF

First Revised Page 95  
Cancels Original Page 95

ISSUED: February 15, 1989  
BY: Joelle Phillips, President - Tennessee  
Nashville, Tennessee

EFFECTIVE: July 2, 1990

## **E7. SPECIAL ACCESS SERVICE**

Reserved For Future Use

BELLSOUTH  
TELECOMMUNICATIONS  
TENNESSEE

ACCESS SERVICES TARIFF

First Revised Page 96  
Cancels Original Page 96

ISSUED: February 15, 1989  
BY: Joelle Phillips, President - Tennessee  
Nashville, Tennessee

EFFECTIVE: July 2, 1990

## **E7. SPECIAL ACCESS SERVICE**

Reserved For Future Use

BELLSOUTH  
TELECOMMUNICATIONS  
TENNESSEE

ACCESS SERVICES TARIFF

First Revised Page 97  
Cancels Original Page 97

ISSUED: February 15, 1989  
BY: Joelle Phillips, President - Tennessee  
Nashville, Tennessee

EFFECTIVE: July 2, 1990

## **E7. SPECIAL ACCESS SERVICE**

Reserved For Future Use

BELLSOUTH  
TELECOMMUNICATIONS  
TENNESSEE

ACCESS SERVICES TARIFF

First Revised Page 98  
Cancels Original Page 98

ISSUED: February 15, 1989

EFFECTIVE: July 2, 1990

BY: Joelle Phillips, President - Tennessee  
Nashville, Tennessee

## **E7. SPECIAL ACCESS SERVICE**

Reserved For Future Use

BELLSOUTH  
TELECOMMUNICATIONS  
TENNESSEE

ACCESS SERVICES TARIFF

First Revised Page 99  
Cancels Original Page 99

ISSUED: February 15, 1989  
BY: Joelle Phillips, President - Tennessee  
Nashville, Tennessee

EFFECTIVE: July 2, 1990

## **E7. SPECIAL ACCESS SERVICE**

Reserved For Future Use

BELLSOUTH  
TELECOMMUNICATIONS  
TENNESSEE

ACCESS SERVICES TARIFF

First Revised Page 100  
Cancels Original Page 100

ISSUED: February 15, 1989  
BY: Joelle Phillips, President - Tennessee  
Nashville, Tennessee

EFFECTIVE: July 2, 1990

## **E7. SPECIAL ACCESS SERVICE**

Reserved For Future Use

BELLSOUTH  
TELECOMMUNICATIONS  
TENNESSEE

ACCESS SERVICES TARIFF

First Revised Page 101  
Cancels Original Page 101

ISSUED: February 15, 1989  
BY: Joelle Phillips, President - Tennessee  
Nashville, Tennessee

EFFECTIVE: July 2, 1990

**E7. SPECIAL ACCESS SERVICE**

Reserved For Future Use

BELLSOUTH  
TELECOMMUNICATIONS  
TENNESSEE

ACCESS SERVICES TARIFF

First Revised Page 102  
Cancels Original Page 102

ISSUED: February 15, 1989  
BY: Joelle Phillips, President - Tennessee  
Nashville, Tennessee

EFFECTIVE: July 2, 1990

**E7. SPECIAL ACCESS SERVICE**

Reserved For Future Use



BELLSOUTH  
TELECOMMUNICATIONS  
TENNESSEE

ACCESS SERVICES TARIFF

First Revised Page 103  
Cancels Original Page 103

ISSUED: February 15, 1989  
BY: Joelle Phillips, President - Tennessee  
Nashville, Tennessee

EFFECTIVE: July 2, 1990

**E7. SPECIAL ACCESS SERVICE**

Reserved For Future Use

BELLSOUTH  
TELECOMMUNICATIONS  
TENNESSEE

ACCESS SERVICES TARIFF

First Revised Page 104  
Cancels Original Page 104

ISSUED: February 15, 1989  
BY: Joelle Phillips, President - Tennessee  
Nashville, Tennessee

EFFECTIVE: July 2, 1990

## **E7. SPECIAL ACCESS SERVICE**

Reserved for Future Use

BELLSOUTH  
TELECOMMUNICATIONS  
TENNESSEE

ACCESS SERVICES TARIFF

First Revised Page 105  
Cancels Original Page 105

ISSUED: February 15, 1989  
BY: Joelle Phillips, President - Tennessee  
Nashville, Tennessee

EFFECTIVE: July 2, 1990

**E7. SPECIAL ACCESS SERVICE**

Reserved For Future Use

BELLSOUTH  
TELECOMMUNICATIONS  
TENNESSEE

ACCESS SERVICES TARIFF

First Revised Page 106  
Cancels Original Page 106

ISSUED: February 15, 1989  
BY: Joelle Phillips, President - Tennessee  
Nashville, Tennessee

EFFECTIVE: July 2, 1990

## **E7. SPECIAL ACCESS SERVICE**

Reserved For Future Use

BELLSOUTH  
TELECOMMUNICATIONS  
TENNESSEE

ACCESS SERVICES TARIFF

First Revised Page 107  
Cancels Original Page 107

ISSUED: February 15, 1989  
BY: Joelle Phillips, President - Tennessee  
Nashville, Tennessee

EFFECTIVE: July 2, 1990

**E7. SPECIAL ACCESS SERVICE**

Reserved For Future Use

BELLSOUTH  
TELECOMMUNICATIONS  
TENNESSEE

ACCESS SERVICES TARIFF

First Revised Page 108  
Cancels Original Page 108

ISSUED: February 15, 1989  
BY: Joelle Phillips, President - Tennessee  
Nashville, Tennessee

EFFECTIVE: July 2, 1990

**E7. SPECIAL ACCESS SERVICE**

Reserved For Future Use

BELLSOUTH  
TELECOMMUNICATIONS  
TENNESSEE

ACCESS SERVICES TARIFF

First Revised Page 109  
Cancels Original Page 109

ISSUED: February 15, 1989  
BY: Joelle Phillips, President - Tennessee  
Nashville, Tennessee

EFFECTIVE: July 2, 1990

**E7. SPECIAL ACCESS SERVICE**

Reserved For Future Use

BELLSOUTH  
TELECOMMUNICATIONS  
TENNESSEE

ACCESS SERVICES TARIFF

First Revised Page 110  
Cancels Original Page 110

ISSUED: February 15, 1989  
BY: Joelle Phillips, President - Tennessee  
Nashville, Tennessee

EFFECTIVE: July 2, 1990

**E7. SPECIAL ACCESS SERVICE**

Reserved For Future Use



BELLSOUTH  
TELECOMMUNICATIONS  
TENNESSEE

ACCESS SERVICES TARIFF

First Revised Page 111  
Cancels Original Page 111

ISSUED: February 15, 1989  
BY: Joelle Phillips, President - Tennessee  
Nashville, Tennessee

EFFECTIVE: July 2, 1990

## **E7. SPECIAL ACCESS SERVICE**

Reserved For Future Use

BELLSOUTH  
TELECOMMUNICATIONS  
TENNESSEE

ACCESS SERVICES TARIFF

First Revised Page 112  
Cancels Original Page 112

ISSUED: February 15, 1989  
BY: Joelle Phillips, President - Tennessee  
Nashville, Tennessee

EFFECTIVE: July 2, 1990

**E7. SPECIAL ACCESS SERVICE**

Reserved For Future Use

BELLSOUTH  
TELECOMMUNICATIONS  
TENNESSEE

ACCESS SERVICES TARIFF

First Revised Page 113  
Cancels Original Page 113

ISSUED: February 15, 1989  
BY: Joelle Phillips, President - Tennessee  
Nashville, Tennessee

EFFECTIVE: July 2, 1990

**E7. SPECIAL ACCESS SERVICE**

Reserved For Future Use

BELLSOUTH  
TELECOMMUNICATIONS  
TENNESSEE

ACCESS SERVICES TARIFF

First Revised Page 114  
Cancels Original Page 114

ISSUED: February 15, 1989  
BY: Joelle Phillips, President - Tennessee  
Nashville, Tennessee

EFFECTIVE: July 2, 1990

**E7. SPECIAL ACCESS SERVICE**

Reserved For Future Use

BELLSOUTH  
TELECOMMUNICATIONS  
TENNESSEE

ACCESS SERVICES TARIFF

First Revised Page 115  
Cancels Original Page 115

ISSUED: February 15, 1989  
BY: Joelle Phillips, President - Tennessee  
Nashville, Tennessee

EFFECTIVE: July 2, 1990

**E7. SPECIAL ACCESS SERVICE**

Reserved For Future Use

BELLSOUTH  
TELECOMMUNICATIONS  
TENNESSEE

ACCESS SERVICES TARIFF

First Revised Page 116  
Cancels Original Page 116

ISSUED: February 15, 1989  
BY: Joelle Phillips, President - Tennessee  
Nashville, Tennessee

EFFECTIVE: July 2, 1990

**E7. SPECIAL ACCESS SERVICE**

Reserved For Future Use

BELLSOUTH  
TELECOMMUNICATIONS  
TENNESSEE

ACCESS SERVICES TARIFF

First Revised Page 117  
Cancels Original Page 117

ISSUED: February 15, 1989  
BY: Joelle Phillips, President - Tennessee  
Nashville, Tennessee

EFFECTIVE: July 2, 1990

**E7. SPECIAL ACCESS SERVICE**

Reserved For Future Use

BELLSOUTH  
TELECOMMUNICATIONS  
TENNESSEE

ACCESS SERVICES TARIFF

First Revised Page 118  
Cancels Original Page 118

ISSUED: February 15, 1989  
BY: Joelle Phillips, President - Tennessee  
Nashville, Tennessee

EFFECTIVE: July 2, 1990

**E7. SPECIAL ACCESS SERVICE**

Reserved For Future Use



BELLSOUTH  
TELECOMMUNICATIONS  
TENNESSEE

ACCESS SERVICES TARIFF

First Revised Page 119  
Cancels Original Page 119

ISSUED: February 15, 1989  
BY: Joelle Phillips, President - Tennessee  
Nashville, Tennessee

EFFECTIVE: July 2, 1990

## **E7. SPECIAL ACCESS SERVICE**

Reserved For Future Use

BELLSOUTH  
TELECOMMUNICATIONS  
TENNESSEE

ACCESS SERVICES TARIFF

First Revised Page 120  
Cancels Original Page 120

ISSUED: February 15, 1989  
BY: Joelle Phillips, President - Tennessee  
Nashville, Tennessee

EFFECTIVE: July 2, 1990

**E7. SPECIAL ACCESS SERVICE**

Reserved For Future Use

BELLSOUTH  
TELECOMMUNICATIONS  
TENNESSEE

ACCESS SERVICES TARIFF

First Revised Page 121  
Cancels Original Page 121

ISSUED: February 15, 1989  
BY: Joelle Phillips, President - Tennessee  
Nashville, Tennessee

EFFECTIVE: July 2, 1990

## **E7. SPECIAL ACCESS SERVICE**

Reserved For Future Use

BELLSOUTH  
TELECOMMUNICATIONS  
TENNESSEE

ACCESS SERVICES TARIFF

Second Revised Page 122  
Cancels First Revised Page 122

ISSUED: February 15, 1989  
BY: Joelle Phillips, President - Tennessee  
Nashville, Tennessee

EFFECTIVE: July 2, 1990

## **E7. SPECIAL ACCESS SERVICE**

Reserved For Future Use

BELLSOUTH  
TELECOMMUNICATIONS  
TENNESSEE

ACCESS SERVICES TARIFF

First Revised Page 122.1  
Cancels Original Page 122.1

ISSUED: February 15, 1989  
BY: Joelle Phillips, President - Tennessee  
Nashville, Tennessee

EFFECTIVE: July 2, 1990

**E7. SPECIAL ACCESS SERVICE**

Reserved For Future Use

BELLSOUTH  
TELECOMMUNICATIONS  
TENNESSEE

ACCESS SERVICES TARIFF

First Revised Page 123  
Cancels Original Page 123

ISSUED: February 15, 1989  
BY: Joelle Phillips, President - Tennessee  
Nashville, Tennessee

EFFECTIVE: July 2, 1990

**E7. SPECIAL ACCESS SERVICE**

Reserved For Future Use

BELLSOUTH  
TELECOMMUNICATIONS  
TENNESSEE

ACCESS SERVICES TARIFF

First Revised Page 124  
Cancels Original Page 124

ISSUED: February 15, 1989  
BY: Joelle Phillips, President - Tennessee  
Nashville, Tennessee

EFFECTIVE: July 2, 1990

**E7. SPECIAL ACCESS SERVICE**

Reserved For Future Use

BELLSOUTH  
TELECOMMUNICATIONS  
TENNESSEE

ACCESS SERVICES TARIFF

First Revised Page 125  
Cancels Original Page 125

ISSUED: February 15, 1989  
BY: Joelle Phillips, President - Tennessee  
Nashville, Tennessee

EFFECTIVE: July 2, 1990

**E7. SPECIAL ACCESS SERVICE**

Reserved For Future Use



BELLSOUTH  
TELECOMMUNICATIONS  
TENNESSEE

ACCESS SERVICES TARIFF

First Revised Page 126  
Cancels Original Page 126

ISSUED: February 15, 1989  
BY: Joelle Phillips, President - Tennessee  
Nashville, Tennessee

EFFECTIVE: July 2, 1990

**E7. SPECIAL ACCESS SERVICE**

Reserved For Future Use

BELLSOUTH  
TELECOMMUNICATIONS  
TENNESSEE

ACCESS SERVICES TARIFF

First Revised Page 127  
Cancels Original Page 127

ISSUED: February 15, 1989  
BY: Joelle Phillips, President - Tennessee  
Nashville, Tennessee

EFFECTIVE: July 2, 1990

**E7. SPECIAL ACCESS SERVICE**

Reserved For Future Use

BELLSOUTH  
TELECOMMUNICATIONS  
TENNESSEE

ACCESS SERVICES TARIFF

First Revised Page 128  
Cancels Original Page 128

ISSUED: February 15, 1989  
BY: Joelle Phillips, President - Tennessee  
Nashville, Tennessee

EFFECTIVE: July 2, 1990

**E7. SPECIAL ACCESS SERVICE**

Reserved For Future Use

BELLSOUTH  
TELECOMMUNICATIONS  
TENNESSEE

ACCESS SERVICES TARIFF

First Revised Page 129  
Cancels Original Page 129

ISSUED: February 15, 1989  
BY: Joelle Phillips, President - Tennessee  
Nashville, Tennessee

EFFECTIVE: July 2, 1990

**E7. SPECIAL ACCESS SERVICE**

Reserved For Future Use