

E7. SPECIAL ACCESS (A.K.A. BELL SOUTH SPA) SERVICE

CONTENTS

E7.1	General		1
E7.1.1	Rate Categories		1
E7.1.2	Reserved For Future Use		3
E7.1.3	Reserved For Future Use		3
E7.1.4	Service Configurations		3
E7.1.5	Alternate Use		5
E7.1.6	Special Facilities Routing		5
E7.1.7	Design Layout Report		5
E7.1.8	Acceptance Testing		5
E7.1.9	Ordering Options and Conditions		5
E7.1.10	Reserved For Future Use		5
E7.2	Service Descriptions for Special Access Service		5.1
E7.2.1	Special Access (a.k.a. BellSouth SPA) Service Categories		5.1
E7.2.2	Digital Services		18
E7.2.3	Service Designator/Network Channel Code Conversion Table		20
E7.2.4	Reserved for Future Use		21
E7.2.5	Reserved for Future Use		21
E7.2.6	Reserved for Future Use		21
E7.2.7	Reserved for Future Use		21
E7.2.8	Reserved for Future Use		21
E7.2.9	Reserved for Future Use		21
E7.2.10	Reserved for Future Use		21
E7.2.11	Reserved for Future Use		21
E7.2.12	Reserved for Future Use		21
E7.2.13	Reserved for Future Use		21
E7.2.14	Reserved For Future Use		21
E7.2.15	Derived Data Channel (a.k.a. BellSouth SPA Derived Data Channel) Service		22.1
E7.2.16	SMARTRing service (a.k.a. BellSouth Dedicated Ring)		22.2
E7.2.17	Reserved for Future Use		23
E7.2.18	BellSouth Metro Ethernet service		23.1

(T)

E7. SPECIAL ACCESS (A.K.A. BELL SOUTH SPA) SERVICE

CONTENTS

E7.3 Facility Interface Codes	23.4	
E7.3.1 Glossary of Facility Interface Codes and Options	23.4	
E7.3.2 Impedance	27	
E7.3.3 Digital Hierarchy Facility Interface Codes (4DS9-*)	27	
E7.4 Rate Regulations	28	
E7.4.1 Types of Rates and Charges	28	
E7.4.2 Surcharge for Special Access (a.k.a. BellSouth SPA) Service	31	
E7.4.3 Minimum Periods	31	
E7.4.4 Moves	31	
E7.4.5 Rate Application Exception Rules	32	
E7.4.6 Mileage Measurement	33	
E7.4.7 Facility Hubs	33.1	(C)
E7.4.8 Share Use Analog and Digital High Capacity Services	34	
E7.4.9 Reserved for Future Use	34.1	
E7.4.10 Multijurisdictional WATS (a.k.a. BellSouth SPA WATS Line) Access Line 1 + IntraLATA Usage	34.1	
E7.4.11 Reserved for Future Use	35	
E7.4.12 BellSouth SPA Customer Network Management (CNM) - FlexServ Service	35	
E7.4.13 Derived Data Channel (a.k.a. BellSouth SPA Derived Data Channel) Service	40	
E7.4.14 SMARTRing Service (a.k.a. BellSouth Dedicated Ring)	40.1	
E7.4.15 Reserved for Future Use	42	
E7.4.16 Reserved for Future Use	42	
E7.4.17 Reserved for Future Use	42.1	
E7.4.18 Reserved for Future Use	42.1	
E7.4.19 Reserved for Future Use	42.1	
E7.4.20 Reserved for Future Use	42.1	
E7.4.21 Reserved for Future Use	42.1	
E7.4.22 Reserved for Future Use	42.1	
E7.4.23 Reserved for Future Use	42.1	
E7.4.24 Reserved for Future Use	42.1	
E7.4.25 Reserved for Future Use	42.1	
E7.4.26 Reserved for Future Use	42.1	
E7.4.27 Reserved for Future Use	42.1	
E7.4.28 Reserved for Future Use	42.1	
E7.4.29 Reserved for Future Use	42.1	
E7.4.30 Reserved for Future Use	42.1	
E7.4.31 Reserved for Future Use	42.1	
E7.4.32 BellSouth Metro Ethernet service	42.2	

E7. SPECIAL ACCESS (A.K.A. BELLSOUTH SPA) SERVICE

CONTENTS

E7.5	Rates and Charges	42.14	
E7.5.1	Reserved for Future Use	42.14	
E7.5.2	Reserved for Future Use	42.14	
E7.5.3	Reserved for Future Use	42.14	
E7.5.4	Reserved for Future Use	42.14	
E7.5.5	Reserved for Future Use	42.14	
E7.5.6	Reserved for Future Use	42.14	
E7.5.7	Voice Grade (a.k.a. BellSouth SPA DS0 VG) Service	43	
E7.5.8	<i>Reserved For Future Use</i>	47	(T)
E7.5.9	Digital Data Access (a.k.a. BellSouth SPA DS0 Digital Data) Service	48	
E7.5.10	High Capacity (a.k.a. BellSouth SPA High Capacity) Service	51	
E7.5.11	Message Station Equipment Recovery Charge	55	
E7.5.12	Special Access (a.k.a. BellSouth SPA) Surcharge	56	
E7.5.13	Transfer of Service	56	
E7.5.14	Reserved for Future Use	56	
E7.5.15	Derived Data Channel (a.k.a. BellSouth SPA Derived Data Channel) Service	57	
E7.5.16	BellSouth SPA Customer Network Management (CNM) - FlexServ Service	58	
E7.5.17	SMARTRing service (a.k.a. BellSouth Dedicated Ring)	60	
E7.5.18	Reserved for Future Use	61.2	
E7.5.19	Reserved for Future Use	61.2	
E7.5.20	Reserved for Future Use	63	
E7.5.21	Reserved for Future Use	63	
E7.5.22	BellSouth Metro Ethernet service	63	

E7. SPECIAL ACCESS (A.K.A. BELLSOUTH SPA) SERVICE

E7.1 General

Special Access (a.k.a. BellSouth SPA) service provides a transmission path to directly connect an IC terminal location in a LATA to the end user's premises, 1 two IC terminal locations, an IC terminal location and a HUB, or an end user premises and a WATS or WATS like serving office.² When special access connects an end user's interLATA private network switching function and an IC terminal location, such access may be ordered by and billed to the end user or IC. Special Access (a.k.a. BellSouth SPA) service includes all exchange access not utilizing Company end office switches. This type of Access Service is used, for example, by IC's for the provision of private line service.

The connections provided by Special Access (a.k.a. BellSouth SPA) service can be either analog or digital. Analog connections are differentiated by spectrum and bandwidth. Digital connections are differentiated by bit rate. The specific types of services (e.g., Narrowband, Voice Grade³ (a.k.a. BellSouth SPA DS0 VG), Wideband Digital) provided under Special Access (a.k.a. BellSouth SPA) service are described in E7.2 following.

E7.1.1 Rate Categories

There are five rate categories which apply to Special Access (a.k.a. BellSouth SPA) service:

- Local Channels (described in A. following)
- Interoffice Channel (described in B. following)
- Optional Features and Functions (described in C. following)
- SMARTRing^{®4} service (a.k.a. BellSouth Dedicated Ring) (described in D. following)

(C)

A. Local Channel

The Local Channel rate category provides for the communications path between the demarcation point at an IC or end user premises and the serving wire center of that premises. Included as part of the Local Channel is a standard channel interface arrangement which defines the technical characteristics associated with the type of facilities to which the access service is to be connected at the Point of Termination (POT) and the type of signaling capability, if any. The signaling capability itself is provided as an optional feature as set forth in E7.2.1.B. following. One Local Channel charge applies per designated premises at which the channel is terminated. This charge will apply even if the premises and the serving wire center are co-located in a Company building. The channels used to provide Special Access (a.k.a. BellSouth SPA) services are further defined in D. following.

B. Interoffice Channel

The Interoffice Channel rate category provides for the transmission facilities between the serving wire centers associated with two designated premises, between a serving wire center associated with a designated premises and a Company Hub or between two Company Hubs. Interoffice Channel is portrayed in mileage bands. There are two rates that apply for each band, i.e., a flat rate per band and a rate per mile.

Note 1: Company Centrex Type Services switches which provide ETN services to end users are considered to be the end user's premises for purposes of administering regulations and rates for special access services connecting the ETN switches and other premises of the end user.

Note 2: The Special Access (a.k.a. BellSouth SPA) service used to provide the connection between an end user premises and a WATS serving office is only for use with BellSouth SWA FGD.

Note 3: Effective June 30, 2021, this Service will no longer be available for purchase by new or existing customers. In addition, requests to move, add, change, or renew existing service arrangements will not be accepted. Following the expiration of a customer's existing term agreement, service will be provided on a month-to-month basis at the applicable Monthly rates until the service is discontinued. The Company currently plans to discontinue this service on or after June 30, 2024.

Note 4: Effective on or after December 1, 2021, neither new nor existing customers will be permitted to purchase new SMARTRing Service (Service). In addition, (A) Service Payment Plans greater than 12-months in length will no longer be available; and (B) requests to move, add, change, upgrade, or downgrade existing service arrangements will not be accepted, with the following exceptions: (1) existing customers will be permitted to modify their existing Service and will be able to add new circuits to their existing Service, but will not be permitted to add new nodes in any locations; and (2) any such new circuits will be subject to the customer's existing term payment plan or term agreement for the Service to which they are added. Following the expiration of a customer's existing term agreement, Service will be provided on a month-to-month basis at the applicable Month-to-Month rates until the Service is discontinued.

(N)

Effective November 30, 2023, unless specified to the contrary in their existing Service agreements, existing customers may not renew Term Payment Plans or term agreements for Service. In addition, no move, add, or change orders of any type will be accepted.

(N)

* Service Mark of BellSouth Intellectual Property Corporation

® Registered Service Mark of BellSouth Intellectual Property Corporation

E7. SPECIAL ACCESS (A.K.A. BELLSOUTH SPA) SERVICE

E7.1 General

E7.1.1 Rate Categories (Cont'd)

C. Optional Features and Functions

The Optional Features and Functions rate category provides for optional features and functions which may be added to a Special Access (a.k.a. BellSouth SPA) service to improve its quality or utility to meet specific communications requirements. These are not necessarily identifiable with specific equipment, but rather represent the end result in terms of performance characteristics which may be obtained. These characteristics may be obtained by using various combinations of equipment. Although the equipment necessary to perform a specified function may be installed at various locations along the path of the service, they will be charged for as a single rate element.

Examples of Optional Features and Functions that are available include, but are not limited to, the following:

- Signaling Capability
- Hubbing Functions
- Conditioning
- Transfer Arrangements
- *BellSouth SPA Customer Network Management (CNM)* - FlexServ service

(D)

E7. SPECIAL ACCESS (A.K.A. BELLSOUTH SPA) SERVICE

E7.1 General (Cont'd)

E7.1.1 Rate Categories (Cont'd)

C. Optional Features and Functions (Cont'd)

A Hub is a Company designated serving wire center at which bridging or channelization functions are performed. The bridging functions performed are to connect three or more designated premises in a multipoint arrangement. The channelization functions are to channelize analog or digital facilities to individual services requiring a lower capacity. National Exchange Carrier Association Tariff FCC No. 4 identifies serving wire centers, Hub locations and the type of bridging or channelization functions available.

Descriptions for each of the available Optional Features and Functions are set forth in E7.2 following.

D. Self-healing Multi-nodal Alternate Route Topology Ring (SMARTRing[®] service [a.k.a. BellSouth Dedicated Ring])

1. Customer Node

Customer Nodes provide ring switching capabilities at customer designated locations other than Telephone Company Premises that are part of SMARTRing[®] service (a.k.a. BellSouth Dedicated Ring). This rate element offers OC-3, OC-3+, OC-12, OC-48, or OC-48+ network capacities. An OC-1 network capacity is available only in an Overlay Ring Arrangement riding the customer's host OC-12, OC-48, or OC-48+ SMARTRing[®] service (a.k.a. BellSouth Dedicated Ring) installed on or after June 3, 1994. A summary of the channel interfaces available with each node are specified in E7.2.16.A following.

2. Customer Channel Interface

A Customer Channel Interface provides DS1, DS3, STS-1 electrical channelization and/or OC-3 and/or OC-12 optical channelization that may take place at each Customer Node of SMARTRing[®] service (a.k.a. BellSouth Dedicated Ring). The Customer Channel Interface rate element applies for every interface capacity that originates or terminates at a Customer Node. A summary of the channel interfaces available with each node are specified in E7.2.16.A. following.

3. Central Office Node

Central Office Nodes provide ring switching capabilities at Telephone Company Central Offices that are a part of SMARTRing[®] service (a.k.a. BellSouth Dedicated Ring). This rate element offers OC-3, OC-3+, OC-12, OC-48, and OC-48+ network capacities. An OC-1 network capacity is available only in an Overlay Ring Arrangement riding the customer's host OC-12, OC-48 or OC-48+ SMARTRing[®] service (a.k.a. BellSouth Dedicated Ring) installed on or after June 3, 1994. A summary of the channel interfaces available with each node are specified in E7.2.16.A. following.

4. Central Office Channel Interface

A Central Office Channel Interface provides DS1, DS3, STS-1 electrical channelization and/or OC-3 and/or OC-12 optical channelization that may take place at each Central Office Node located on SMARTRing[®] service (a.k.a. BellSouth Dedicated Ring). The Central Office Channel Interface rate element applies for every interface capacity that originates or terminates at a Central Office Node. A summary of the channel interfaces available with each node are specified in E7.2.16.A. following. Customers with DS3 or STS-1 interfaces at the Customer Node electing to connect with DS1 services at a Central Office Node, must obtain a 28-DS1 Channel System.

5. Local Channel

The Local Channel rate category provides for the communications path between a Customer Node and the serving wire center of the premises where located. Charges for Local Channels apply as described in A. preceding. It is available with all capacities of SMARTRing[®] service (a.k.a. BellSouth Dedicated Ring) except OC-1.

6. Alternate Central Office Channel

The Alternate Central Office Channel provides for the communications path between a customer node and an alternate central office. It is available with all capacities of SMARTRing[®] service (a.k.a. BellSouth Dedicated Ring) except OC-1.

7. Interoffice Channel

The Interoffice Channel provides for the communications path between directly connected Telephone Company central offices located on a SMARTRing[®] service (a.k.a. BellSouth Dedicated Ring). It is available with all capacities of SMARTRing[®] service (a.k.a. BellSouth Dedicated Ring) except OC-1. This rate element does not apply where Central Office Nodes are adjacently connected in the same Central Office on the same SMARTRing[®] service (a.k.a. BellSouth Dedicated Ring) for the purpose of providing additional node capacity.

Note 1: Effective on or after December 1, 2021, neither new nor existing customers will be permitted to purchase new SMARTRing Service (Service). In addition, (A) Service Payment Plans greater than 12-months in length will no longer be available; and (B) requests to move, add, change, upgrade, or downgrade existing service arrangements will not be accepted, with the following exceptions: (1) existing customers will be permitted to modify their existing Service and will be able to add new circuits to their existing Service, but will not be permitted to add new nodes in any locations; and (2) any such new circuits will be subject to the customer's existing term payment plan or term agreement for the Service to which they are added. Following the expiration of a customer's existing term agreement, Service will be provided on a month-to-month basis at the applicable Month-to-Month rates until the Service is discontinued.

Effective November 30, 2023, unless specified to the contrary in their existing Service agreements, existing customers may not renew Term Payment Plans or term agreements for Service. In addition, no move, add, or change orders of any type will be accepted.

E7. SPECIAL ACCESS (A.K.A. BELLSOUTH SPA) SERVICE

E7.1 General (Cont'd)

E7.1.1 Rate Categories (Cont'd)

- D. Self-healing Multi-nodal Alternate Route Topology Ring (SMARTRing^{®3} service [a.k.a. BellSouth Dedicated Ring]) (Cont'd)
8. Internodal Channel
The Internodal Channel provides for the communications path between two directly connected Customer Nodes of a given SMARTRing[®] service (a.k.a. BellSouth Dedicated Ring) located (a) in the same Serving Wire Center area or (b) in the same Office Park/Campus Environment or contiguous property, located in contiguous Serving Wire Center areas. It is available with all capacities of SMARTRing[®] service (a.k.a. BellSouth Dedicated Ring) except OC-1. This rate element does not apply where Customer Nodes are adjacently connected in the same building on the same SMARTRing[®] service (a.k.a. BellSouth Dedicated Ring) for the purpose of providing additional node capacity.
 9. Channel Interface Capacity Reallocation
Channel Interface Capacity Reallocation allows the customer to reallocate STS-1, DS3 capacity interfaces at each node subsequent to the initial service installation.
- E. Channel Types
There are nine types of channels used to provide Special Access (a.k.a. BellSouth SPA) services. Each type has its own characteristics. All are subdivided by one or more of the following:
- Transmission specifications - Speed (i.e., bit rate)
 - Bandwidth - Spectrum

A basic channel and a list of available transmission parameters and channel interfaces, those that they desire to meet specific communications requirements can be ordered.

For purposes of ordering channels, each has been identified as a type of Special Access (a.k.a. BellSouth SPA) service. However, such identification is not intended to limit the use of the channel nor to imply that the channel is limited to a particular use. For example, if an end user's equipment is capable of transmitting voice over a channel that is identified as Metallic² (a.k.a. BellSouth SPA Metallic) service in this Tariff, there is no restriction against doing so.

Following is a brief description of each type of channel:

Metallic² (a.k.a. BellSouth SPA Metallic) - a channel for the transmission of low speed varying signals at rates up to 30 baud.

Telegraph Grade² (a.k.a. BellSouth SPA Telegraph) - a channel for the transmission of binary signals at rates of 0 to 75 baud or 0 to 150 baud.

Voice Grade² (a.k.a. BellSouth SPA DS0 VG) - a channel for the transmission of analog signals within an approximate bandwidth of 300-3000 Hz.

WATS Access Line² (a.k.a. BellSouth SPA WATS Line) (WAL) - a channel from a customer designated premises to a WATS serving office for 800, WATS, or similar services.

(DELETED)

Commercial Quality Video (a.k.a. BellSouth SPA Commercial Quality Video) - a channel for the transmission of video signal(s) for non-broadcast use. The service includes two associated 12 kHz audio signals. (T)

Note 1: **(DELETED)** (T)

Note 2: Effective June 30, 2021, this Service will no longer be available for purchase by new or existing customers. In addition, requests to move, add, change, or renew existing service arrangements will not be accepted. Following the expiration of a customer's existing term agreement, service will be provided on a month-to-month basis at the applicable Monthly rates until the service is discontinued. The Company currently plans to discontinue this service on or after June 30, 2024.

Note 3: Effective on or after December 1, 2021, neither new nor existing customers will be permitted to purchase new SMARTRing Service (Service). In addition, (A) Service Payment Plans greater than 12-months in length will no longer be available; and (B) requests to move, add, change, upgrade, or downgrade existing service arrangements will not be accepted, with the following exceptions: (1) existing customers will be permitted to modify their existing Service and will be able to add new circuits to their existing Service, but will not be permitted to add new nodes in any locations; and (2) any such new circuits will be subject to the customer's existing term payment plan or term agreement for the Service to which they are added. Following the expiration of a customer's existing term agreement, Service will be provided on a month-to-month basis at the applicable Month-to-Month rates until the Service is discontinued.

Effective November 30, 2023, unless specified to the contrary in their existing Service agreements, existing customers may not renew Term Payment Plans or term agreements for Service. In addition, no move, add, or change orders of any type will be accepted.

E7. SPECIAL ACCESS (A.K.A. BELLSOUTH SPA) SERVICE

E7.1 General (Cont'd)

E7.1.1 Rate Categories (Cont'd)

E. (Cont'd)

Digital Data¹ (a.k.a. BellSouth SPA DS0 Digital Data) - a channel for the digital transmission of synchronous serial data at rates of 2.4, 4.8, 9.6, 19.2, 56.0 or 64.0 Kbps. (M)(C)

High Capacity (a.k.a. BellSouth SPA High Capacity) - a channel for the transmission of isochronous serial digital data at rates of 1.544, 3.152, 6.312, or 44.736 Mbps. (M)

Derived Data Channel¹ (a.k.a. BellSouth SPA Derived Data Channel) - a digital data channel, derived from a two-wire local exchange line, that transmits voice and data signals simultaneously. A Derived Data Channel (a.k.a. BellSouth SPA Derived Data Channel) provides digital transmission of data at 2.4 Kbps. (M)(C)

Detailed descriptions of each of the channel types are provided in E7.2. following.

The option also exists for ordering digital high capacity facilities (i.e., 1.544 Mbps, 3.152 Mbps, 6.312 Mbps and 44.736 Mbps) to a Company Hub for channelization to individual channels of a lower capacity. Descriptions of the types of channelization available at the hubs, as well as the number of individual channels which may be derived from each type of facility are set forth in E7.2 following. Additionally, the IC may specify optional features for the individual channels derived from the facility to further tailor the channel to meet specific communications requirements. Descriptions of the optional features and functions available are also set forth in E7.2 following. (M)

F. Virtual Collocation Cross-Connects

Virtual Collocation Cross-Connects provide a means for customers to interconnect their Shared Use and Digital High Capacity (a.k.a. BellSouth SPA High Capacity) to central office virtual collocation arrangements. Virtual Collocation Cross-Connect rates and charges for these features are provided in E7.5 following.

Note 1: Effective June 30, 2021, this Service will no longer be available for purchase by new or existing customers. In addition, requests to move, add, change, or renew existing service arrangements will not be accepted. Following the expiration of a customer's existing term agreement, service will be provided on a month-to-month basis at the applicable Monthly rates until the service is discontinued. The Company currently plans to discontinue this service on or after June 30, 2024. (M)(C)

E7. SPECIAL ACCESS (A.K.A. BELLSOUTH SPA) SERVICE

E7.1 General (Cont'd)

E7.1.2 Reserved for Future Use (M)

E7.1.3 Reserved for Future Use (M)

E7.1.4 Service Configurations (M)

There are *three* types of service configurations over which Special Access (a.k.a. BellSouth SPA) services are provided, two-point service and multipoint service. (C)(M)

A. Two-Point Service (M)

1. A two-point service is a channel which is provided to connect two locations. The locations connected may be: (M)

a. An IC terminal location and an end user's premises whether, provided directly or through a Company designated facility hub, (M)

b. An IC terminal location and a Company Central Office in which a Centrex CO or other Central Office derived service is located, or (M)

c. An IC terminal location and a Hub, or (M)

d. Two IC terminal locations. (M)

2. All Special Access (a.k.a. BellSouth SPA) services may be provided as two-point service. (M)

B. Multipoint Service

1. A multipoint service is a channel that is provided to connect three or more locations. The locations connected may be:

a. An IC terminal location and two or more end users' premises,

b. All IC terminal locations

c. Multiple IC terminal locations and multiple end user's premises.

2. Only certain types of Special Access (a.k.a. BellSouth SPA) service are provided as multipoint services. These are so designated in the Service Descriptions set forth in E7.2.1 and E7.2.2 following. Multipoint Service is available with a maximum of three mid-links in tandem; however, the specific number of bridges on a given service will be determined by the Company.

3. Multipoint service is provided in the following manner:

a. The Company will designate serving wire centers where bridging (by service type) is available. These serving wire centers are referred to as Hubs.

b. The IC will specify the bridging serving wire center (i.e., Hub), selected from the Company list of available locations.

c. Service will be priced as provided.

Local Channel from IC terminal location to IC serving wire center. (Additional IC terminal locations will be treated as end user premises.)

Interoffice Channel from the IC serving wire center to the bridging serving wire center (may also be end user serving wire center).

Appropriate bridging equipment charge.

Interoffice Channel from the bridging serving wire center to the end user serving wire center, if required.

Local Channel from the end user wire center to end user premises (per end user location).

In addition, a Special Access (a.k.a. BellSouth SPA) Surcharge as set forth in E7.4.2. following and a Message Station Equipment Recovery Charge as set forth in E7.4.3. following may be applicable.

E7. SPECIAL ACCESS (A.K.A. BELLSOUTH SPA) SERVICE

E7.1 General (Cont'd)

E7.1.4 Service Configurations (Cont'd)

- B. Multipoint Service (Cont'd)
 - 3. Multipoint service is provided in the following manner: (Cont'd)
 - c. Service will be priced as provided. (Cont'd)

Example: Voice Grade¹ (*a.k.a. BellSouth SPA DS0 VG*) multipoint connecting four customer premises via two customer specified bridging hubs. (C)

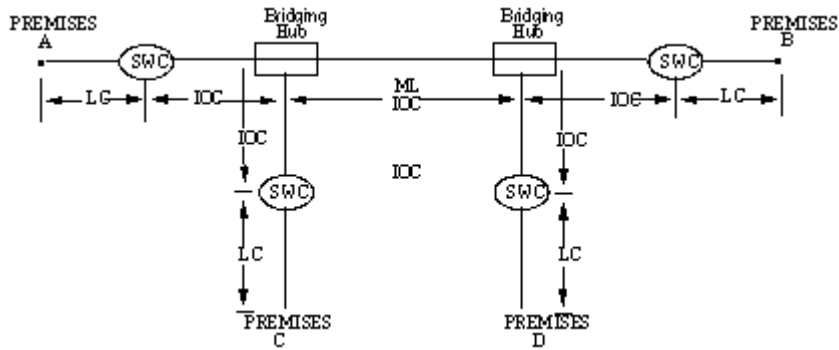

LC - Local Channel
 IOC - Interoffice Channel
 B - Bridging
 SWC - Serving Wire Center

- Applicable rate elements are:
- Local Channels (4 applicable)
 - Interoffice Channel (5 sections, each from appropriate mileage band)
 - Bridging Optional Feature (6 applicable, i.e., each bridge port)

Note 1: Effective June 30, 2021, this Service will no longer be available for purchase by new or existing customers. In addition, requests to move, add, change, or renew existing service arrangements will not be accepted. Following the expiration of a customer's existing term agreement, service will be provided on a month-to-month basis at the applicable Monthly rates until the service is discontinued. The Company currently plans to discontinue this service on or after June 30, 2024. (N)

E7. SPECIAL ACCESS (A.K.A. BELLSOUTH SPA) SERVICE

E7.1 General (Cont'd)

E7.1.4 Service Configurations (Cont'd)

C. SMARTRing[®] service (a.k.a. BellSouth Dedicated Ring)

(C)

1. The SMARTRing[®] service (a.k.a. BellSouth Dedicated Ring) configuration utilizes a multi-nodal ring architecture which is specified jointly by the Company and the customer. The minimum configuration provides dedicated DS3 and/or DS1 digital services and must include at least three nodes. The three nodes may all be Central Office Nodes in Telephone Company Central Offices, or the three nodes may be a Central Office Node in a Telephone Company Central Office, a Customer Node at a customer's designated location and the third node may be either a Central Office Node or a node at another customer designated location. Additional nodes for either arrangement may be any combination thereof. The maximum number of nodes will be determined based on equipment capability. The nodes are connected by SMARTRing[®] service (a.k.a. BellSouth Dedicated Ring) Local Channels, Alternate Central Office Channels, Interoffice Channels and Internodal Channels as applicable. SMARTRing[®] service (a.k.a. BellSouth Dedicated Ring) may be connected to other DS3/DS1 services only at Central Office Nodes. With OC-12 SMARTRing[®] service (a.k.a. BellSouth Dedicated Ring) installed on or after June 3, 1994, and with OC-48 and OC-48+ SMARTRing[®] service (a.k.a. BellSouth Dedicated Ring) the customer may request an OC-1 and/or OC-3 Overlay Ring Arrangement riding the customer's host OC-12, OC-48, or OC-48+ SMARTRing[®] service (a.k.a. BellSouth Dedicated Ring). With OC-48 SMARTRing[®] service (a.k.a. BellSouth Dedicated Ring), the customer may request an OC-3+ and/or OC-12 Overlay Ring Arrangement riding the customer's host OC-48 SMARTRing[®] service (a.k.a. BellSouth Dedicated Ring). In an Overlay Ring Arrangement, node and channel configuration requirements apply to the host SMARTRing[®] service (a.k.a. BellSouth Dedicated Ring).
2. Applicable rate elements for this service are:
 - a. Customer Node (at least one for configurations other than three Central Office Node arrangement)
 - b. Customer Channel Interface (one for each originating/terminating activated DS1, DS3, STS-1, OC-3, and/or OC-12 for each Customer Node)
 - c. Central Office Node (at least one for configurations other than three Central Office Node arrangement)
 - d. Central Office Channel Interface (one for each originating/terminating activated DS1, DS3, STS-1, OC-3 and/or OC-12 for each Central Office Node or one for each 28 DS1 Channel System and associated DS1 Channel Interfaces for each activated DS3)
 - e. Local Channel (at least one for each Customer Node which is directly connected to the serving wire center)
 - f. Alternate Central Office Channel (at least one for each Customer Node which is directly connected to an Alternate Central Office)
 - g. Internodal Channel (one for each path between two directly connected customer nodes)
 - h. Interoffice Channel (one for each path between each two directly connected Telephone Company Central Offices)
 - i. Channel Interface Capacity Reallocation (one per node per occurrence)

Note 1: Effective on or after December 1, 2021, neither new nor existing customers will be permitted to purchase new SMARTRing Service (Service). In addition, (A) Service Payment Plans greater than 12-months in length will no longer be available; and (B) requests to move, add, change, upgrade, or downgrade existing service arrangements will not be accepted, with the following exceptions: (1) existing customers will be permitted to modify their existing Service and will be able to add new circuits to their existing Service, but will not be permitted to add new nodes in any locations; and (2) any such new circuits will be subject to the customer's existing term payment plan or term agreement for the Service to which they are added. Following the expiration of a customer's existing term agreement, Service will be provided on a month-to-month basis at the applicable Month-to-Month rates until the Service is discontinued.

(N)

Effective November 30, 2023, unless specified to the contrary in their existing Service agreements, existing customers may not renew Term Payment Plans or term agreements for Service. In addition, no move, add, or change orders of any type will be accepted.

(N)

E7. SPECIAL ACCESS (A.K.A. BELLSOUTH SPA) SERVICE

E7.1 General (Cont'd)

E7.1.4 Service Configurations

C. SMARTRing[®] service (a.k.a. BellSouth Dedicated Ring) (Cont'd)

(C)

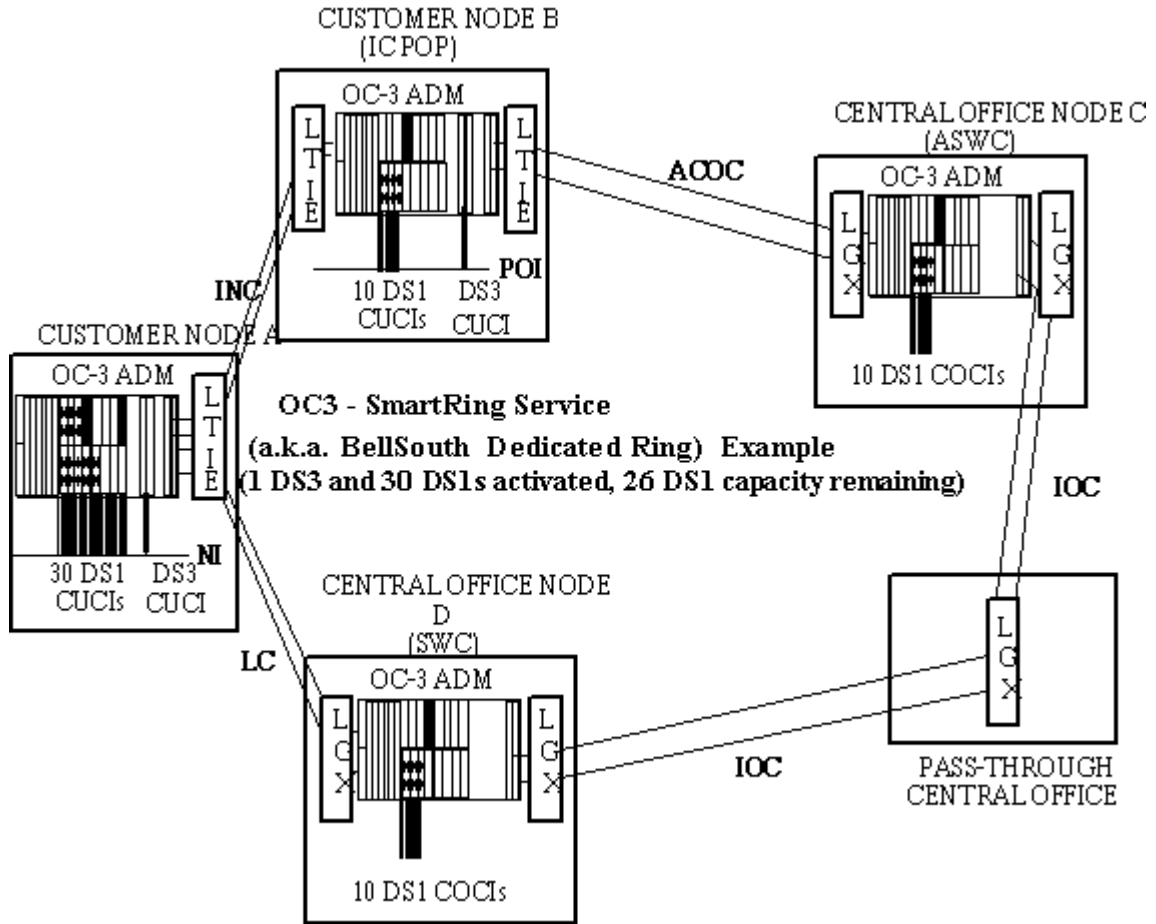

Example: SMARTRing[®] service (a.k.a. BellSouth Dedicated Ring) OC-3 capacity.

For this example the following rate elements are applicable:

(C)

- 2 Customer Nodes
- 2 Central Office Nodes
- 1 Local Channel
- 1 Internodal Channel
- 1 Alternate Central Office Channel
- 2 Interoffice Channels
- 2 DS3 Customer Channel Interfaces
- 40 DS1 Customer Channel Interfaces
- 20 DS1 Central Office Channel Interfaces

Note 1: Effective on or after December 1, 2021, neither new nor existing customers will be permitted to purchase new SMARTRing Service (Service). In addition, (A) Service Payment Plans greater than 12-months in length will no longer be available; and (B) requests to move, add, change, upgrade, or downgrade existing service arrangements will not be accepted, with the following exceptions: (1) existing customers will be permitted to modify their existing Service and will be able to add new circuits to their existing Service, but will not be permitted to add new nodes in any locations; and (2) any such new circuits will be subject to the customer's existing term payment plan or term agreement for the Service to which they are added. Following the expiration of a customer's existing term agreement, Service will be provided on a month-to-month basis at the applicable Month-to-Month rates until the Service is discontinued.

(N)

Effective November 30, 2023, unless specified to the contrary in their existing Service agreements, existing customers may not renew Term Payment Plans or term agreements for Service. In addition, no move, add, or change orders of any type will be accepted.

(N)

E7. SPECIAL ACCESS (A.K.A. BELLSOUTH SPA) SERVICE

E7.1 General (Cont'd)

E7.1.4 Service Configurations (Cont'd)

C. SMARTRing[®] service (a.k.a. BellSouth Dedicated Ring) (Cont'd)

(C)

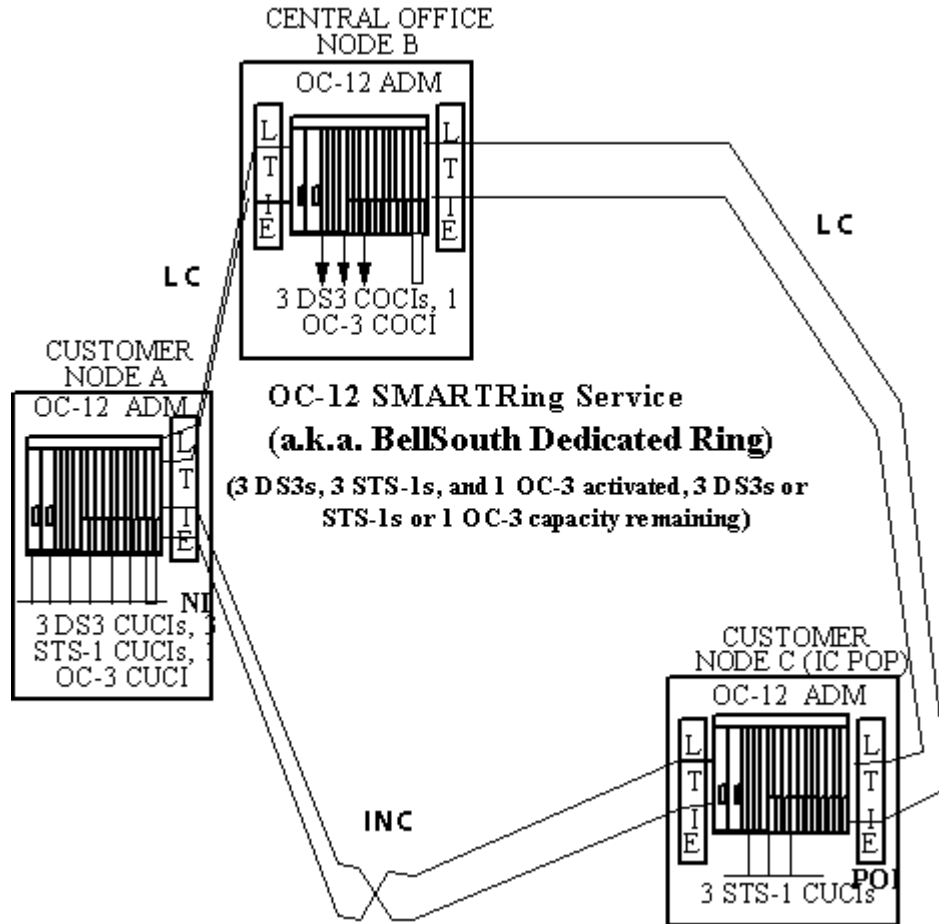

Example: SMARTRing[®] service (a.k.a. BellSouth Dedicated Ring) OC-12 capacity.

For this example the following rate elements are applicable:

(C)

- 2 Customer Nodes
- 1 Internodal Channel
- 6 STS-1 Customer Channel Interfaces
- 1 Central Office Nodes
- 3 DS3 Customer Channel Interfaces
- 1 OC-3 Customer Channel Interface
- 2 Local Channels
- 3 DS3 Central Office Channel Interfaces
- 1 OC-3 Central Office Channel Interface

Note 1: Effective on or after December 1, 2021, neither new nor existing customers will be permitted to purchase new SMARTRing Service (Service). In addition, (A) Service Payment Plans greater than 12-months in length will no longer be available; and (B) requests to move, add, change, upgrade, or downgrade existing service arrangements will not be accepted, with the following exceptions: (1) existing customers will be permitted to modify their existing Service and will be able to add new circuits to their existing Service, but will not be permitted to add new nodes in any locations; and (2) any such new circuits will be subject to the customer's existing term payment plan or term agreement for the Service to which they are added. Following the expiration of a customer's existing term agreement, Service will be provided on a month-to-month basis at the applicable Month-to-Month rates until the Service is discontinued.

(N)

Effective November 30, 2023, unless specified to the contrary in their existing Service agreements, existing customers may not renew Term Payment Plans or term agreements for Service. In addition, no move, add, or change orders of any type will be accepted.

(N)

E7. SPECIAL ACCESS (A.K.A. BELL SOUTH SPA) SERVICE

E7.1 General (Cont'd)

E7.1.4 Service Configurations (Cont'd)

C. SMARTRing[®] service (a.k.a. BellSouth Dedicated Ring) (Cont'd)

(C)

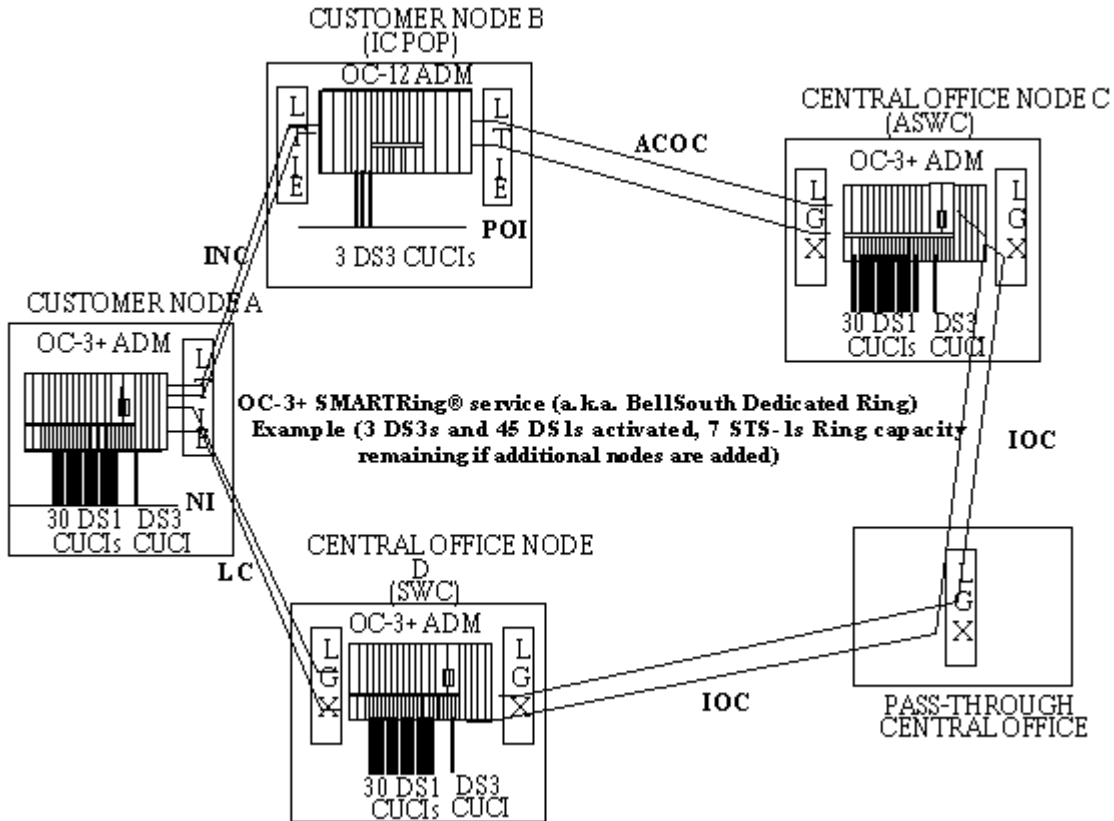

Example: SMARTRing[®] service (a.k.a. BellSouth Dedicated Ring) OC-3+ capacity.

For this example the following rate elements are applicable:

(C)

- 2 Customer Nodes
- 1 Alternate Central Office Channel
- 2 DS3 Central Office Channel Interfaces
- 2 Central Office Nodes
- 2 Interoffice Channels
- 30 DS1 Customer Channel Interfaces
- 1 Local Channel
- 4 DS3 Customer Channel Interfaces
- 60 DS1 Central Office Channel Interfaces
- 1 Internodal Channel

Note 1: Effective on or after December 1, 2021, neither new nor existing customers will be permitted to purchase new SMARTRing Service (Service). In addition, (A) Service Payment Plans greater than 12-months in length will no longer be available; and (B) requests to move, add, change, upgrade, or downgrade existing service arrangements will not be accepted, with the following exceptions: (1) existing customers will be permitted to modify their existing Service and will be able to add new circuits to their existing Service, but will not be permitted to add new nodes in any locations; and (2) any such new circuits will be subject to the customer's existing term payment plan or term agreement for the Service to which they are added. Following the expiration of a customer's existing term agreement, Service will be provided on a month-to-month basis at the applicable Month-to-Month rates until the Service is discontinued.

(N)

Effective November 30, 2023, unless specified to the contrary in their existing Service agreements, existing customers may not renew Term Payment Plans or term agreements for Service. In addition, no move, add, or change orders of any type will be accepted.

(N)

E7. SPECIAL ACCESS (A.K.A. BELL SOUTH SPA) SERVICE

E7.1 General (Cont'd)

E7.1.4 Service Configurations (Cont'd)

C. SMARTRing[®] service (a.k.a. BellSouth Dedicated Ring) (Cont'd)

(C)

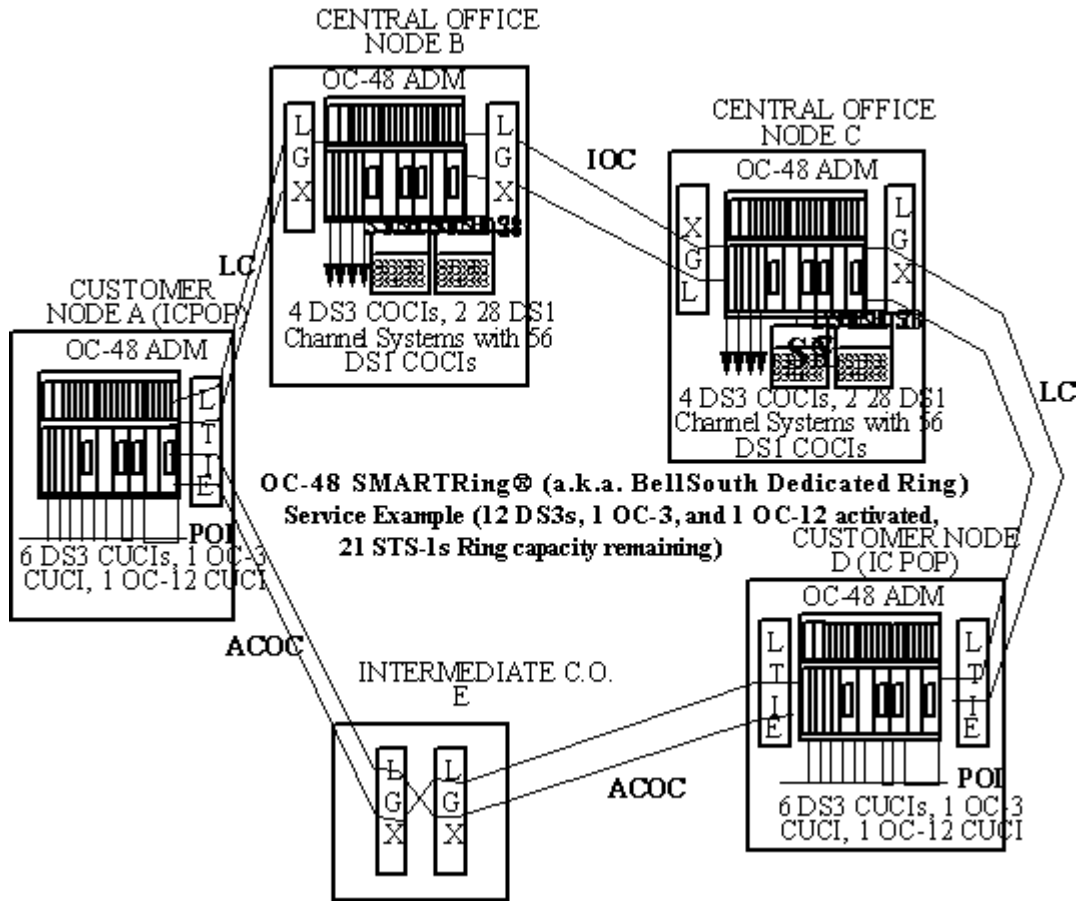

Example: SMARTRing[®] service (a.k.a. BellSouth Dedicated Ring) OC-48 capacity.

For this example the following rate elements are applicable:

(C)

- 2 Customer Nodes
- 2 Alternate Central Office Channels
- 112 DS1 Central Office Channel Interfaces
- 2 Central Office Nodes
- 12 DS3 Customer Channel Interfaces
- 2 OC-3 Customer Channel Interfaces
- 2 Local Channels
- 8 DS3 Central Office Channel Interfaces
- 2 OC-12 Customer Channel Interfaces
- 1 Interoffice Channel
- 4 28 DS1 Channel Systems (DS3)

Note 1: Effective on or after December 1, 2021, neither new nor existing customers will be permitted to purchase new SMARTRing Service (Service). In addition, (A) Service Payment Plans greater than 12-months in length will no longer be available; and (B) requests to move, add, change, upgrade, or downgrade existing service arrangements will not be accepted, with the following exceptions: (1) existing customers will be permitted to modify their existing Service and will be able to add new circuits to their existing Service, but will not be permitted to add new nodes in any locations; and (2) any such new circuits will be subject to the customer's existing term payment plan or term agreement for the Service to which they are added. Following the expiration of a customer's existing term agreement, Service will be provided on a month-to-month basis at the applicable Month-to-Month rates until the Service is discontinued.

(N)

Effective November 30, 2023, unless specified to the contrary in their existing Service agreements, existing customers may not renew Term Payment Plans or term agreements for Service. In addition, no move, add, or change orders of any type will be accepted.

(N)

E7. SPECIAL ACCESS (A.K.A. BELLSOUTH SPA) SERVICE

E7.1 General (Cont'd)

E7.1.4 Service Configurations (Cont'd)

C. SMARTRing[®] service (a.k.a. BellSouth Dedicated Ring) (Cont'd)

(C)

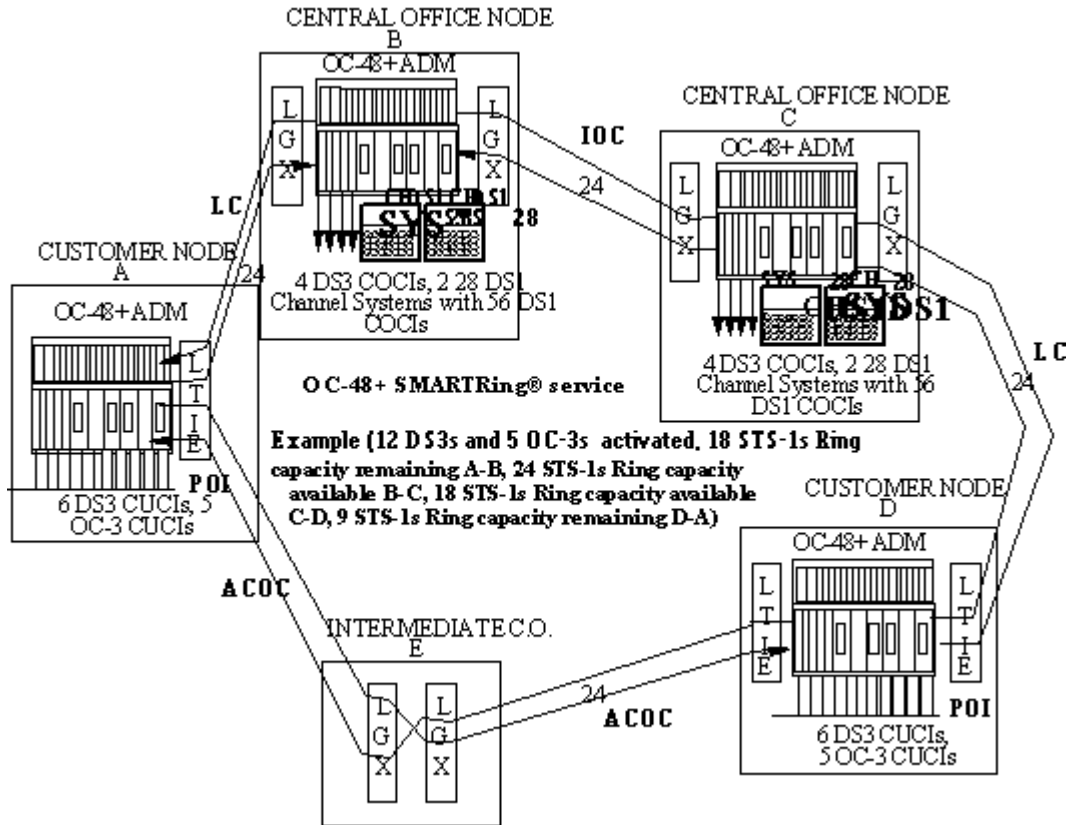

Example: SMARTRing[®] service (a.k.a. BellSouth Dedicated Ring) service OC-48+ capacity.

For this example the following rate elements are applicable:

(C)

- 2 Customer Nodes
- 2 Alternate Central Office Channels
- 4 28 DS1 Channel Systems (DS3)
- 2 Central Office Nodes
- 12 DS3 Customer Channel Interfaces
- 112 DS1 Central Office Channel Interfaces
- 2 Local Channels
- 8 DS3 Central Office Channel Interfaces
- 10 OC-3 Customer Channel Interfaces
- 1 Interoffice Channel

Note 1: Effective on or after December 1, 2021, neither new nor existing customers will be permitted to purchase new SMARTRing Service (Service). In addition, (A) Service Payment Plans greater than 12-months in length will no longer be available; and (B) requests to move, add, change, upgrade, or downgrade existing service arrangements will not be accepted, with the following exceptions: (1) existing customers will be permitted to modify their existing Service and will be able to add new circuits to their existing Service, but will not be permitted to add new nodes in any locations; and (2) any such new circuits will be subject to the customer's existing term payment plan or term agreement for the Service to which they are added. Following the expiration of a customer's existing term agreement, Service will be provided on a month-to-month basis at the applicable Month-to-Month rates until the Service is discontinued.

(N)

Effective November 30, 2023, unless specified to the contrary in their existing Service agreements, existing customers may not renew Term Payment Plans or term agreements for Service. In addition, no move, add, or change orders of any type will be accepted.

(N)

E7. SPECIAL ACCESS (A.K.A. BELL SOUTH SPA) SERVICE

E7.1 General (Cont'd)

E7.1.5 Alternate Use

Alternate Use occurs when an IC uses a service for different types of transmission at different times. The IC may transfer from one type of operation to another at will, but only one type of transmission can be used at a time.

The Company will review each request for alternate use on an individual case basis. If it agrees to allow the alternate use, the arrangement required to transfer the service from one operation to the other (i.e., the transfer relay and control leads) will be rated and provided on an individual case basis and filed in Section E12., Specialized Service or Arrangements. The IC will pay the stated tariff rates for the Access Service rate elements ordered (i.e., Local Channel and Interoffice Channel.)

E7.1.6 Special Facilities Routing

An IC may request that the facilities used to provide Special Access (a.k.a. BellSouth SPA) service be specially routed. The regulations, rates and charges for Special Facilities Routing (i.e., Avoidance, Diversity and Cable Only) are as set forth in Section E11. following.

E7.1.7 Design Layout Report

- A. Where the Company normally designs facilities and services, the Company will provide to the IC the make-up of such facilities and services provided under this Tariff as Special Access (a.k.a. BellSouth SPA) to aid the IC in designing its overall service. This information will be provided in the form of a Design Layout Report.
- B. The Design Layout Report will be provided to the IC at no charge.

E7.1.8 Acceptance Testing

- A. At no additional charge, the Company will, at the IC's request, cooperatively test, at the time of installation, the following parameters:
 1. For Voice Grade¹ (VG) (a.k.a. BellSouth SPA DS0 VG) services 1, 2, 3, 6, 7, 8, 9, 10, 11 and 12 (C)
 - a. Loss
 - b. Three-tone slope
 - c. D.C. continuity
 - d. Operational Signaling
 - e. Balance (equal level echo path loss) when the Access Connection provides a four-wire voice transmission interface and the network interface provides two-wire voice transmission (i.e., there is a four-wire to two-wire conversion in Special Transport).
 2. Additionally, for Voice Grade¹ (VG) (a.k.a. BellSouth SPA DS0 VG) services 6, 7, 8, 9, 10, 11 and 12 (C)
 - a. C-notched noise tests.
 3. All other services will be tested to the performance parameters specified for the individual services.
- B. If acceptance tests are not started within 30 minutes after the scheduled appointment time for such tests, as negotiated between the Company and the IC, additional charges may apply, as set forth in Section E13. following.

E7.1.9 Ordering Options and Conditions

- A. The ordering option available to an IC in the provision of Special Access (a.k.a. BellSouth SPA) service is an Access Order.
- B. This option is set forth in detail in Section E5. preceding, as are the conditions under which the option may be elected. Cancellation charges associated with this option are also included in Section E5. preceding.
- C. Terms and conditions for central office interconnection of collocator-provided transmission equipment are set forth in BellSouth Telecommunications, Inc., Tariff F.C.C. No. 1, Section 20. Virtual Collocation Cross-Connect rates and charges are provided in E7.5 following for each service allowed under collocation guidelines.

E7.1.10 Reserved For Future Use

Note 1: Effective June 30, 2021, this Service will no longer be available for purchase by new or existing customers. In addition, requests to move, add, change, or renew existing service arrangements will not be accepted. Following the expiration of a customer's existing term agreement, service will be provided on a month-to-month basis at the applicable Monthly rates until the service is discontinued. The Company currently plans to discontinue this service on or after June 30, 2024.

E7. SPECIAL ACCESS (A.K.A. BELL SOUTH SPA) SERVICE

E7.2 Service Descriptions for Special Access (a.k.a. BellSouth SPA) Service

E7.2.1 Special Access (a.k.a. BellSouth SPA) Service Categories

For the purpose of ordering, there are seven categories of Special Access (a.k.a. BellSouth SPA) service. These are:

(C)

- Voice Grade¹ (a.k.a. BellSouth SPA DS0 VG) (VG)
- Commercial Quality Video (a.k.a. BellSouth SPA Commercial Quality Video) (TV)
- Digital Data¹ (a.k.a. BellSouth SPA DS0 Digital Data) (DA)
- High Capacity (a.k.a. BellSouth SPA High Capacity) (HC)
- WATS Access Line¹ (a.k.a. BellSouth SPA WATS Line) (WAL)
- Derived Data Channel¹ (a.k.a. BellSouth SPA Derived Data Channel) service (DDCS)
- Self-Healing Rings (SMARTRing² service {a.k.a. BellSouth Dedicated Ring})

Each service consists of a basic channel to which a technical specifications package (predefined), channel interface(s) and, when desired, optional features and functions are added to construct the service desired. Each of the components of the service are described in this section. Terms, conditions, and rates for Physical Access Collocation Cross-Connects and Virtual Access Collocation Cross-Connects are set forth in Section E13. of this Tariff for those services that are permitted to connect directly to a carrier's collocation space.

The channel description specifies the characteristics of the basic channel and indicates whether the channel is provided between designated premises or between a designated premises and a Company hub where bridging and/or channelization functions are performed.

Information pertaining to the technical specifications packages indicates the transmission parameters that are available with each package. This information is displayed in a matrix with the transmission parameters listed down the left side and the packages listed across the top. Each package is identified by a code, e.g., VG1. The first two letters of the code indicate the category of Special Access (a.k.a. BellSouth SPA) service to which the parameters are applicable. These two-letter codes are shown preceding in parentheses following the category of Special Access (a.k.a. BellSouth SPA) service. A numeric designation following the two letter code indicates the specific predefined package. When appropriate, the Technical Reference which contains detailed specifications for the parameters is shown following the matrix.

Channel interfaces at each point of termination on a two-point service may be symmetrical or asymmetrical. On a multipoint service they may also be symmetrical or asymmetrical. However, communications can only be provided between points of termination with compatible channel interfaces. Only certain channel interfaces are compatible. These are set forth in a combination format.

Only certain channel interface combinations are available with the predefined technical specifications packages. These are delineated in the Technical References set forth at the end of this E7.2.

The optional features and functions available with each type of Special Access (a.k.a. BellSouth SPA) service are described in this section. The optional features and functions information also indicates with which technical specifications packages they are available. Such information is displayed in a matrix with the optional feature or function listed down the left side and the technical specifications package listed across the top.

Note 1: Effective June 30, 2021, this Service will no longer be available for purchase by new or existing customers. In addition, requests to move, add, change, or renew existing service arrangements will not be accepted. Following the expiration of a customer's existing term agreement, service will be provided on a month-to-month basis at the applicable Monthly rates until the service is discontinued. The Company currently plans to discontinue this service on or after June 30, 2024.

Note 2: Effective on or after December 1, 2021, neither new nor existing customers will be permitted to purchase new SMARTRing Service (Service). In addition, (A) Service Payment Plans greater than 12-months in length will no longer be available; and (B) requests to move, add, change, upgrade, or downgrade existing service arrangements will not be accepted, with the following exceptions: (1) existing customers will be permitted to modify their existing Service and will be able to add new circuits to their existing Service, but will not be permitted to add new nodes in any locations; and (2) any such new circuits will be subject to the customer's existing term payment plan or term agreement for the Service to which they are added. Following the expiration of a customer's existing term agreement, Service will be provided on a month-to-month basis at the applicable Month-to-Month rates until the Service is discontinued.

(N)

Effective November 30, 2023, unless specified to the contrary in their existing Service agreements, existing customers may not renew Term Payment Plans or term agreements for Service. In addition, no move, add, or change orders of any type will be accepted.

(N)

E7. SPECIAL ACCESS (A.K.A. BELL SOUTH SPA) SERVICE

E7.2 Service Descriptions for Special Access (a.k.a. BellSouth SPA) Service (Cont'd)

E7.2.1 Special Access (a.k.a. BellSouth SPA) Service Categories (Cont'd)

All services installed will conform to the transmission specification standards contained in this Tariff or in the following Technical References for such category of service:

(DELETED)			
(DELETED)			
Voice Grade ¹ (a.k.a. BellSouth SPA DS0 VG)		TR-NPL-000335	(C)
(DELETED)			
Digital Data Access ¹ (a.k.a. BellSouth SPA DS0 Digital Data)		TR-NPL-000341	(C)
For 2.4, 4.8, 9.6 and 56.0 Kbps		BellCore PUB 62310	
For 19.2 Kbps		INC. BULLETIN CB-INC-100	
For 64.0 Kbps		AT&T PUB 62310	
High Capacity (a.k.a. BellSouth SPA High Capacity)		TA-TSY-000342	
WATS Access Line ¹ (a.k.a. BellSouth SPA WATS Line)		TR-NPL-000054	(C)
Commercial Quality Video (a.k.a. BellSouth SPA Commercial Quality Video)		BellSouth TR-73557	
Derived Data Channel ¹ (a.k.a. BellSouth SPA Derived Data Channel Service)		BellSouth TR-73548 BellSouth TR-73548, Addendum 1	(C)

Note 1: Effective June 30, 2021, this Service will no longer be available for purchase by new or existing customers. In addition, requests to move, add, change, or renew existing service arrangements will not be accepted. Following the expiration of a customer's existing term agreement, service will be provided on a month-to-month basis at the applicable Monthly rates until the service is discontinued. The Company currently plans to discontinue this service on or after June 30, 2024.

E7. SPECIAL ACCESS (A.K.A. BELLSOUTH SPA) SERVICE

E7.2 Service Descriptions for Special Access (a.k.a. BellSouth SPA) Service (Cont'd)

E7.2.1 Special Access (a.k.a. BellSouth SPA) Service Categories (Cont'd)

A. (DELETED)

(D)

E7. SPECIAL ACCESS (A.K.A. BELLSOUTH SPA) SERVICE

E7.2 Service Descriptions for Special Access (a.k.a. BellSouth SPA) Service (Cont'd)

E7.2.1 Special Access (a.k.a. BellSouth SPA) Service Categories (Cont'd)

A. (DELETED) (Cont'd)

(D)

E7. SPECIAL ACCESS (A.K.A. BELLSOUTH SPA) SERVICE

E7.2 Service Descriptions for Special Access (a.k.a. BellSouth SPA) Service (Cont'd)

E7.2.1 Special Access (a.k.a. BellSouth SPA) Service Categories (Cont'd)

B. Voice Grade¹ (a.k.a. BellSouth SPA DS0 VG) Services

(C)

1. Basic Channel Description

A Voice Grade (a.k.a. BellSouth SPA DS0 VG) channel is a channel which provides voice frequency transmission capability in the normal frequency range of 300 to 3000 Hz and may be terminated two-wire or four-wire. Voice Grade (a.k.a. BellSouth SPA DS0 VG) channels are provided between customer designated premises or between a customer designated premises and a Company Hub.

Voice Grade (a.k.a. BellSouth SPA DS0 VG) channels are classified as Voice Grade/Voice or Voice Grade/Data depending on the suitability of the technical specification package requested by the IC. Voice Grade (a.k.a. BellSouth SPA DS0 VG) technical specification packages 1, 2, 3, 4, 5, 7, 8, 9, 11 and 12 are suitable for Voice Grade/Voice. Technical specification packages 6 and 10 are suitable for Voice Grade/Data service.

2. Technical Specifications Packages

Parameter	Package VG-											
	1	2	3	4	5	6	7	8	9	10	11	12
Attenuation Distortion	X	X	X	X	X	X	X	X	X	X	X	X
C-Message Noise	X	X	X	X	X	X	X	X	X	X	X	X
Echo Control	X	X	X		X		X	X			X	X
Envelope Delay												
Distortion						X	X	X	X	X	X	X
Frequency Shift						X	X	X	X	X	X	X
Impulse Noise					X	X	X	X	X	X	X	X
Intermodulation												
Distortion						X	X	X	X	X	X	X
Loss Deviation	X	X	X	X	X	X	X	X	X	X	X	X
Phase Jitter						X	X	X	X	X	X	X
Signal-to-C												
Message Noise				X								
Signal-to-C												
Notch Noise					X	X	X	X	X	X	X	X

The technical specifications for these parameters are delineated in Technical Reference TR-NPL-000335 and associated Addendum.

Note 1: Effective June 30, 2021, this Service will no longer be available for purchase by new or existing customers. In addition, requests to move, add, change, or renew existing service arrangements will not be accepted. Following the expiration of a customer's existing term agreement, service will be provided on a month-to-month basis at the applicable Monthly rates until the service is discontinued. The Company currently plans to discontinue this service on or after June 30, 2024.

(N)
|
(N)

E7. SPECIAL ACCESS (A.K.A. BELL SOUTH SPA) SERVICE

E7.2 Service Descriptions for Special Access (a.k.a. BellSouth SPA) Service (Cont'd)

E7.2.1 Special Access (a.k.a. BellSouth SPA) Service Categories (Cont'd)

- B.** Voice Grade³ (a.k.a. BellSouth SPA DS0 VG) Services (Cont'd) (C)
3. Channel Interfaces
- a. The following channel interfaces for Voice Grade (a.k.a. BellSouth SPA DS0 VG) service do not require signaling capability: AH, DA, DB, DD, DE, DS, NO, PR and TF.
- b. The following channel interfaces for Voice Grade (a.k.a. BellSouth SPA DS0 VG) service require signaling capability: AB, AC, CT, DX, EA, EB, EC, EX, GO, GS, LA, LB, LC, LO, LR, LS, RV and SF.
- c. Compatible channel interfaces are set forth in Technical Reference TR-NPL-A and Associated Addendum.
4. Optional Features and Functions
- a. Central Office Bridging Capability
- Voice Bridging¹ (two-wire and four-wire)
 - Data Bridging² (two-wire and four-wire)
 - Telephoto Bridging (two-wire and four-wire)
- (DELETED)**
- (DELETED)**
- (DELETED)**
- (DELETED)**
- (DELETED)**
- b. Central Office Channelization
- Voice (a.k.a. BellSouth SPA DS0 VG) to Telegraph Grade³ (a.k.a. BellSouth SPA Telegraph): An arrangement that converts a Voice Grade (a.k.a. BellSouth SPA DS0 VG) channel to Telegraph Grade³ (a.k.a. BellSouth SPA Telegraph) channels. (C)
- c. Conditioning
- Conditioning provides more specific transmission characteristics for Voice Grade (a.k.a. BellSouth SPA DS0 VG) services. C-Type conditioning controls attenuation distortion and envelope delay distortion. Sealing Current helps maintain continuity on dry metallic³ loops. (C)
- In addition, an IC may desire that either the attenuation distortion or the envelope delay distortion, or both, be improved to more stringent specifications than those provided for C-Type conditioning. In such cases the IC has the option of ordering Improved Attenuation Distortion and/or Improved Envelope Delay Distortion.
- For two-point services, the parameters apply to each service. For multipoint services, the parameters apply to each mid link or end link. C-Type conditioning and D-Conditioning may be combined on the same service.
- Note 1:** Voice Bridging is intended for use with VG2, 5, 11 and 12, however, it may be used on VG6 and VG10 at a customer's request.
- Note 2:** Data Bridging is intended for use with VG6 and VG10, however, it may be used on VG2, 5, 11 and 12 at a customer's request.
- Note 3:** Effective June 30, 2021, this Service will no longer be available for purchase by new or existing customers. In addition, requests to move, add, change, or renew existing service arrangements will not be accepted. Following the expiration of a customer's existing term agreement, service will be provided on a month-to-month basis at the applicable Monthly rates until the service is discontinued. The Company currently plans to discontinue this service on or after June 30, 2024. (N)

E7. SPECIAL ACCESS (A.K.A. BELL SOUTH SPA) SERVICE

E7.2 Service Descriptions for Special Access (*a.k.a. BellSouth SPA*) Service (Cont'd)

E7.2.1 Special Access (*a.k.a. BellSouth SPA*) Service Categories (Cont'd)

B. Voice Grade¹ (*a.k.a. BellSouth SPA DS0 VG*) Services (Cont'd) (C)

4. Optional Features and Functions (Cont'd)

c. Conditioning (Cont'd)

- C-Type Conditioning

C-Type Conditioning is provided for the additional control of attenuation distortion and envelope delay distortion on data services. The attenuation distortion and envelope delay distortion specifications for C-Type Conditioning are:

Attenuation Distortion (Frequency Response) Relative to 1004 Hz

Frequency Range (Hz)	Variation (dB)
504 - 2804	-1.0 to + 3.0
304 - 3004	- 2.0 to + 6.0

Envelope Delay Distortion

Frequency Range (Hz)	Variation (micro-seconds)
1004 - 2604	Less Than 501
604 - 2604	Less Than 1501
504 - 2804	Less Than 3001

- Improved Attenuation Distortion

Improved attenuation distortion is provided for additional control of attenuation distortion. The improved attenuation distortion specifications are:

Attenuation Distortion (Frequency Response) Relative to 1004 Hz

Frequency Range (Hz)	Variation (dB)
404-2804	-1.0 to +2.0
304-3004	-1.0 to +3.0
3004-3204	-2.0 to +6.0

- Improved Envelope Delay Distortion

Improved envelope delay distortion is provided for additional control of envelope distortion. The improved envelope delay distortion specifications are:

Envelope Delay Distortion

Frequency Range (Hz)	Variation (micro-seconds)
1001-2604	Less Than 101
604-2604	Less Than 301
504-2804	Less Than 3001

Note 1: Effective June 30, 2021, this Service will no longer be available for purchase by new or existing customers. In addition, requests to move, add, change, or renew existing service arrangements will not be accepted. Following the expiration of a customer's existing term agreement, service will be provided on a month-to-month basis at the applicable Monthly rates until the service is discontinued. The Company currently plans to discontinue this service on or after June 30, 2024.

(N)
|
(N)

E7. SPECIAL ACCESS (A.K.A. BELL SOUTH SPA) SERVICE

E7.2 Service Descriptions for Special Access (a.k.a. BellSouth SPA) Service (Cont'd)

E7.2.1 Special Access (a.k.a. BellSouth SPA) Service Categories (Cont'd)

B. Voice Grade¹ (a.k.a. BellSouth SPA DS0 VG) Services (Cont'd) (C)

4. Optional Features and Functions (Cont'd)

c. Conditioning (Cont'd)

- Sealing Current Conditioning

Sealing Current Conditioning is provided to help maintain continuity on dry metallic¹ loops. It is usually associated with four-wire DA or NO type channel interfaces. (C)

d. Customer Specified Premises Receive Level

This option allows the IC to specify the receive level at the Point of Termination *for a two or four wire interface at the IC's premises. For a two-wire interface, the IC must order an effective four-wire channel and must specify a receive level within the range allowable for effective four-wire transmission. For a four-wire interface the receive level specified must be within the range allowable for four wire transmission. The IC can order improved termination for a wider range of receive levels.* The ranges are delineated in Technical Reference TR-NPL-000335.

e. Echo Control

(1) Improved Return Loss

On Effective Two-Wire Transmission at Two-Wire Point of Termination: Provides for more stringent Echo Control specifications. In order for this option to be applicable, the transmission path must be four-wire at one POT and two-wire at the other POT. Placement of Company equipment may be required at the customer's end user with the two-wire POT. The Improved Return Loss parameters are delineated in Technical Reference TR-NPL-000335.

(2) ELEPL 2 (Equal Level Echo Path Loss)

Specified at the Four-Wire Point of Termination and provides for more stringent Echo Control. In order for this option to be applicable, the interface must be two-wire at one Point of Termination (POT) and four-wire at the other POT. The ELEPL 2 parameters are delineated in Technical Reference TR-NPL-000335.

f. D-Conditioning

D-Conditioning provides transmission characteristics suitable for data communications. Specifically, D-Conditioning provides for the control of Signal to C-Notched Noise Ratio and intermodulation distortion. It is available for two-point services or multipoint services. This option is available for use with Technical Specification Packages VG6, VG7 and VG10 on Two-Point or Multipoint Services. (However, it is not recommended for use with Multipoint.

D-Conditioning transmission characteristics are described in Technical Reference TR-NPL-000335 under the name Data Capability.

The signal to C-Notched Noise Ratio and intermodulation distortion parameters for D-Conditioning are:

- Signal to C-Notched Noise Ratio is equal to or greater than 32dB

- Intermodulation distortion:

- Signal to second order modulation products (R2) is equal to or greater than 38dB

- Signal to third order modulation products (R3) is equal to or greater than 42dB

Note 1: Effective June 30, 2021, this Service will no longer be available for purchase by new or existing customers. In addition, requests to move, add, change, or renew existing service arrangements will not be accepted. Following the expiration of a customer's existing term agreement, service will be provided on a month-to-month basis at the applicable Monthly rates until the service is discontinued. The Company currently plans to discontinue this service on or after June 30, 2024.

(N)
|
(N)

E7. SPECIAL ACCESS (A.K.A. BELLSOUTH SPA) SERVICE

E7.2 Service Descriptions for Special Access (*a.k.a. BellSouth SPA*) Service (Cont'd)

E7.2.1 Special Access (*a.k.a. BellSouth SPA*) Service Categories (Cont'd)

B. Voice Grade¹ (*a.k.a. BellSouth SPA DS0 VG*) Services (Cont'd) (C)

4. Optional Features and Functions (Cont'd)

f. D-Conditioning (Cont'd)

When a service equipped with D-Conditioning and is used for voice communications, the quality of the voice transmission may not be satisfactory.

g. Telephoto Conditioning

Telephoto Conditioning provides transmission characteristics suitable for telephotographic communications. Specifically, Telephoto Conditioning is provided for the control of attenuation distortion and envelope delay distortion parameters for Telephoto Conditioning are:

Attenuation Distortion

(2204 Hz Reference)

Frequency Range (Hz)	Variation (dB)
304 - 3204	- 1.0 to + 2.5
504 - 3004	- 0.5 to + 1.5

Envelope Delay Distortion

Frequency Range (Hz)	Variation (mcs)
1004 - 2604	Less Than 111
804 - 2804	Less Than 181

h. Signaling Capability

Signaling Capability provides for the process by which one premises alerts another premises on the same service with which it wishes to communicate.

i. Selective Signaling Arrangement

An arrangement that permits code selective ringing for up to ten codes on a multipoint service.

j. Transfer Arrangement

An arrangement that affords the an additional measure of flexibility in the use of their access channel(s). The arrangement can be utilized to transfer a leg of a Special Access (*a.k.a. BellSouth SPA*) service to another channel that terminates in either the same or a different premises. A key activated or dial-up control service is required to operate the transfer arrangement. A spare channel, if required, is not included as part of the option.

k. Improved Termination

The Improved Termination option provides a fixed 600 ohms impedance, a variable level range and simplex reversal, when applicable, at the point of termination. Company equipment is required at the IC's premises when this option is ordered. The Improved Termination parameters are delineated in Technical Reference TR-NPL-000335.

Note 1: Effective June 30, 2021, this Service will no longer be available for purchase by new or existing customers. In addition, requests to move, add, change, or renew existing service arrangements will not be accepted. Following the expiration of a customer's existing term agreement, service will be provided on a month-to-month basis at the applicable Monthly rates until the service is discontinued. The Company currently plans to discontinue this service on or after June 30, 2024.

(N)
|
(N)

E7. SPECIAL ACCESS (A.K.A. BELLSOUTH SPA) SERVICE

E7.2 Service Descriptions for Special Access (a.k.a. BellSouth SPA) Service (Cont'd)

E7.2.1 Special Access (a.k.a. BellSouth SPA) Service Categories (Cont'd)

B. Voice Grade¹ (a.k.a. BellSouth SPA DS0 VG) Services (Cont'd)

(C)

4. Optional Features and Functions (Cont'd)

l. Simplex Reversal

The Simplex Reversal option physically turns over the simplex DC path presented at the four-wire point of termination when LO, LS, GO, GS, & DX signaling is provided at the point of termination.

m. **BellSouth SPA Customer Network Management (CNM)** - FlexServ service

BellSouth SPA CNM - FlexServ service provides the customer the ability to monitor and reconfigure Voice Grade (a.k.a. BellSouth SPA DS0 VG) service provided by the Company. **BellSouth SPA CNM** - FlexServ service is described in E7.4.12 following. Charges for this feature are contained in E7.5.16 following.

The following table shows the technical specifications packages with which the optional features and functions are available.

	Available with Technical Specifications Package VG-											
	1	2	3	4	5	6	7	8	9	10	11	12
C-Type Conditioning					X	X	X	X	X	X		
Improved Attenuation												
Distortion					X	X	X	X	X	X		
Improved Envelope												
Delay Distortion					X	X	X	X	X	X		
Sealing Current												
Conditioning					X	X				X		
D-Conditioning						X	X			X		
Central Office												
Bridging		X			X	X				X	X	X
Central Office												
Multiplexing						X						
Customer Specified												
Premises Receive												
Level		X	X				X	X	X			
Echo Control												
Improved Return												
Loss		X	X				X					
ELEPL2	X	X	X		X		X					
BellSouth SPA CNM - FlexServ Service	X	X	X	X	X	X	X	X	X	X	X	X
Improved Termination	X	X	X	X	X	X	X	X	X	X	X	X
Simplex Reversal	X	X	X				X	X	X			
Selective Signaling												
Arrangement		X										

Note 1: Effective June 30, 2021, this Service will no longer be available for purchase by new or existing customers. In addition, requests to move, add, change, or renew existing service arrangements will not be accepted. Following the expiration of a customer's existing term agreement, service will be provided on a month-to-month basis at the applicable Monthly rates until the service is discontinued. The Company currently plans to discontinue this service on or after June 30, 2024.

(N)
|
(N)

E7. SPECIAL ACCESS (A.K.A. BELLSOUTH SPA) SERVICE

E7.2 Service Descriptions for Special Access (a.k.a. BellSouth SPA) Service (Cont'd)

E7.2.1 Special Access (a.k.a. BellSouth SPA) Service Categories (Cont'd)

B. Voice Grade¹ (a.k.a. BellSouth SPA DS0 VG) Services (Cont'd)

(C)

4. Optional Features and Functions (Cont'd)

	Available with Technical Specifications Package VG-											
	1	2	3	4	5	6	7	8	9	10	11	12
Signaling Capability	X	X	X				X	X	X			
Telephoto												
Conditioning										X		
Transfer Arrangement	X	X	X	X	X	X	X	X	X	X	X	X

5. Four-Wire/Two-Wire Conversions

(T)

When it is requested that an effective four-wire channel be terminated with a two-wire channel interface, a four-wire to two-wire conversion of the four-wire local channel is required. The rate for the conversion is included as part of the basic Local Channel.

Note 1: Effective June 30, 2021, this Service will no longer be available for purchase by new or existing customers. In addition, requests to move, add, change, or renew existing service arrangements will not be accepted. Following the expiration of a customer's existing term agreement, service will be provided on a month-to-month basis at the applicable Monthly rates until the service is discontinued. The Company currently plans to discontinue this service on or after June 30, 2024.

(N)

(N)

E7. SPECIAL ACCESS (A.K.A. BELLSOUTH SPA) SERVICE

E7.2 Service Descriptions for Special Access (a.k.a. BellSouth SPA) Service (Cont'd)

E7.2.1 Special Access (a.k.a. BellSouth SPA) Service Categories (Cont'd)

B. Voice Grade¹ (a.k.a. BellSouth SPA DS0 VG) Services (Cont'd) (C)

6. WATS Access Line¹ (WAL) (a.k.a. BellSouth SPA WATS Line) service (C)

a. Basic Channel Description

A WATS Access Line (a.k.a. BellSouth SPA WATS Line) service (WAL) provides a channel for voice frequency transmission capability. The service provides a connection between a customer designated premises and a WATS serving office associated with the closed end of *BellSouth SWA*, WATS (a.k.a. *BellSouth SPA WATS Line*) or similar services. It is provided for use with Feature Group D in the originating and terminating direction and *BellSouth SWA FGA* and *BellSouth SWA FGB* in the terminating direction and *BellSouth SWA* arrangement features as set forth in Section 6 of Tariff FCC No. 1. The Company is currently unable to provide originating WATS (a.k.a. *BellSouth SPA WATS Line*) service through *BellSouth SWA FGA* and *BellSouth SWA FGB*. Such service will be provided as specified in (2) and (3) following.

The following shall apply to the Company's provision of WATS Access Line (a.k.a. *BellSouth SPA WATS Line*) service:

- (1) When the end user's serving wire center is not a WATS serving office, Interoffice Channel charges will apply for a WATS (a.k.a. *BellSouth SPA WATS Line*) access line extension (WALE) between the end user's serving wire center and the nearest WATS serving office.
- (2) When a IC, other than AT&T, orders originating WATS Access Line (a.k.a. *BellSouth SPA WATS Line*) service and the end user's serving wire center is a WATS serving office which is not equipped with equal access, the Company will provide the WAL service to the nearest equal access WATS serving office by use of a WALE and the interoffice channel charges for the WALE will be waived.
- (3) When a IC other than AT&T orders originating WATS Access Line (a.k.a. *BellSouth SPA WATS Line*) service and the end user's serving wire center is not a WATS serving office and the nearest WATS serving office is not equipped with equal access, interoffice channel charges for a WALE to the nearest WATS serving office will apply, as indicated in (1) preceding, but the Company will provide an additional WALE to the nearest WATS serving office equipped with equal access and the interoffice channel charge for the additional WALE will be waived.

WATS Access Line (a.k.a. *BellSouth SPA WATS Line*) service is arranged for either originating calling or terminating calling. It is provided with either rotary dial or dual tone multifrequency address signaling and either loop start, ground start, E & M or reverse battery supervisory signaling. The choice of the type of signaling is at the option of the IC and subject to the technical limitations identified in the Technical Reference TR-NPL-000334. WATS Access Line (a.k.a. *BellSouth SPA WATS Line*) service is provided as an effective two-wire, an effective four-wire or a DS1 (i.e., 1.544 Mbps) transmission path. The DS1 WAL is only available as a trunk side termination on suitably equipped electronic switch, e.g., 1/1A ESS with Digital Carrier Termination (DCT) or DMS-100 with a Line Trunk Unit (LTU).

Note 1: Effective June 30, 2021, this Service will no longer be available for purchase by new or existing customers. In addition, requests to move, add, change, or renew existing service arrangements will not be accepted. Following the expiration of a customer's existing term agreement, service will be provided on a month-to-month basis at the applicable Monthly rates until the service is discontinued. The Company currently plans to discontinue this service on or after June 30, 2024.

(N)
|
(N)

E7. SPECIAL ACCESS (A.K.A. BELLSOUTH SPA) SERVICE

E7.2 Service Descriptions for Special Access (a.k.a. BellSouth SPA) Service (Cont'd)

E7.2.1 Special Access (a.k.a. BellSouth SPA) Service Categories (Cont'd)

- B. Voice Grade¹ (a.k.a. BellSouth SPA DS0 VG) Services (Cont'd) (C)
- 6. WATS Access Line¹ (WAL) (a.k.a. BellSouth SPA WATS Line) service (Cont'd) (C)
 - b. Technical Specification Packages

Parameters	Package Wal -		
	1	2	3
Attenuation Distortion	X	X	
Bit error rate			X
C-Message Noise	X	X	
Echo Control	X	X	
Envelope Delay Distortion	X	X	
Frequency Shift	X	X	
Impulse Noise	X	X	
Intermodulation Distortion	X	X	
Loss Deviation	X	X	
Phase Jitter	X	X	
Signal-to-C Notch Noise	X	X	

The technical specifications are delineated in Technical Reference TR-NPL-000334.

- c. The following interfaces are available with WAL Service:
 - LO, LS, DS, GO, GS, RV, EA, EB
 - Compatible channel interfaces are set forth in Technical Reference TR-NPL-000334.
- d. Optional Features and Functions
 - (1) Two-wire and four-wire Central Office bridging capability.
 - (2) Improved two-wire voice transmission specifications.
 - (3) Certain other options associated with WAL services such as WATS Access Line (a.k.a. BellSouth SPA WATS Line), Nonchargeable Termination Options and Common Switching Optional Features are available as defined in Section E6. preceding.
 - (4) One-way or Two-way Capability

Note 1: Effective June 30, 2021, this Service will no longer be available for purchase by new or existing customers. In addition, requests to move, add, change, or renew existing service arrangements will not be accepted. Following the expiration of a customer's existing term agreement, service will be provided on a month-to-month basis at the applicable Monthly rates until the service is discontinued. The Company currently plans to discontinue this service on or after June 30, 2024. (N)

E7. SPECIAL ACCESS (A.K.A. BELLSOUTH SPA) SERVICE

E7.2 Service Descriptions for Special Access (a.k.a. BellSouth SPA) Service (Cont'd)

E7.2.1 Special Access (a.k.a. BellSouth SPA) Service Categories (Cont'd)

C. (DELETED)

(D)

E7. SPECIAL ACCESS (A.K.A. BELLSOUTH SPA) SERVICE

E7.2 Service Descriptions for Special Access (a.k.a. BellSouth SPA) Service (Cont'd)

E7.2.1 Special Access (a.k.a. BellSouth SPA) Service Categories (Cont'd)

C. (DELETED) (Cont'd)

E7.2.2 Digital Services

A. Digital Data Access¹ (a.k.a. BellSouth SPA DS0 Digital Data) service

(C)

1. Basic Channel Description

- a. A Digital Data (a.k.a. BellSouth SPA DS0 Digital Data) channel is a channel for four-wire transmission of synchronous serial data at the rate of 2.4, 4.8, 9.6, 19.2, 56.0 or 64.0 Kbps. The actual bit rate is a function of the channel interface and channel selected by the IC. The channel provides a synchronous service with timing provided by the Company through the Company's facilities to the IC in the received bit stream. Digital Data (a.k.a. BellSouth SPA DS0 Digital Data) channels are only available via Company designated Digital Data (a.k.a. BellSouth SPA DS0 Digital Data) Hubs and are provided between IC designated premises or between an end user designated premises and a Company Digital Data (a.k.a. BellSouth SPA DS0 Digital Data) Hub.
- b. A Hub termination charge applies per Digital Local Channel. This rate element covers the Hub functions (e.g., timing, testing) for the service.
- c. Secondary Channel Capability (SCC) is a derived companion digital transmission path that is independent of the primary data path and operates at a substantially lower bit rate. This derived channel allows the IC to perform network management functions during the normal operation of the network. This diagnostics channel utilizes a portion of an IC's previously unavailable data bit stream allowing for the ability to remotely control and test the network and peripheral devices without taking the network out of service. Special end user equipment is necessary to utilize the benefits of the Secondary Channel. End users not wishing to utilize this capability will not be impacted. Due to transmission equipment restrictions, Secondary Channel capability cannot be provided on 56.0 Kbps circuits that require the installation of loop repeater equipment for provision of service. Secondary Channel capability, also, cannot be provided on 64.0 Kbps circuits, since all the available bit stream will be used by the customer.
- d. The end user will provide the Channel Service Unit-type equipment or other Network Channel Terminating Equipment associated with the Digital Data (a.k.a. BellSouth SPA DS0 Digital Data) channel at the end user premises. The interim program for interconnection of such equipment is set forth in Technical Reference PUB AS No. 1.

Note 1: Effective June 30, 2021, this Service will no longer be available for purchase by new or existing customers. In addition, requests to move, add, change, or renew existing service arrangements will not be accepted. Following the expiration of a customer's existing term agreement, service will be provided on a month-to-month basis at the applicable Monthly rates until the service is discontinued. The Company currently plans to discontinue this service on or after June 30, 2024.

(N)

(N)

E7. SPECIAL ACCESS (A.K.A. BELLSOUTH SPA) SERVICE

E7.2 Service Descriptions for Special Access (a.k.a. BellSouth SPA) Service (Cont'd)

E7.2.2 Digital Services (Cont'd)

- A. Digital Data Access³ (*a.k.a. BellSouth SPA DS0 Digital Data*) service (Cont'd) (C)
- 2. Technical Specifications Packages

Parameter	Package DA-					
	1	2	3	4	5	6
Error-Free Seconds	X	X	X	X	X	X

The Company will provide a channel capable of meeting a monthly average performance equal to or greater than 99.875 percent error-free seconds¹ while the channel is in service, if it is measured through a CSU equivalent which is designed, manufactured, and maintained to conform with the interconnection specifications contained in Technical Reference PUB 62310.

Interface options and service objectives are as specified in Technical Reference TR-NPL-000341.

- 3. Channel Interfaces

The following channel interfaces (CIs) define the bit rates that are available for a Digital Data (*a.k.a. BellSouth SPA DS0 Digital Data*) Access channel:

CI	Bit Rate
DU-24(S) ²	2.4 Kbps
DU-48(S) ²	4.8 Kbps
DU-96(S) ²	9.6 Kbps
DU-19(S) ²	19.2 Kbps
DU-56(S) ²	56.0 Kbps
DU-64	64.0 Kbps

Compatible channel interfaces are set forth in Technical Reference TR-NPL-000341.

Note 1: This channel performance does not apply when the Data Over Voice Channel option is used in lieu of a DDAS (*a.k.a. BellSouth SPA DS0 Digital Data*) Local Channel.

Note 2: (S) is an additional BellSouth designation for use when the optional Secondary Channel feature is required.

Note 3: Effective June 30, 2021, this Service will no longer be available for purchase by new or existing customers. In addition, requests to move, add, change, or renew existing service arrangements will not be accepted. Following the expiration of a customer's existing term agreement, service will be provided on a month-to-month basis at the applicable Monthly rates until the service is discontinued. The Company currently plans to discontinue this service on or after June 30, 2024.

(N)
|
(N)

E7. SPECIAL ACCESS (A.K.A. BELL SOUTH SPA) SERVICE

E7.2 Service Descriptions for Special Access (a.k.a. BellSouth SPA) Service (Cont'd)

E7.2.2 Digital Services (Cont'd)

- A. Digital Data Access¹ (a.k.a. BellSouth SPA DS0 Digital Data) service (Cont'd) (C)
- 4. Optional Features and Functions
 - a. Central Office Bridging Capability
 - b. **BellSouth SPA Customer Network Management (CNM)** - FlexServ service
BellSouth SPA CNM - FlexServ service provides the IC the ability to monitor and reconfigure Digital Data Access (a.k.a. BellSouth SPA DS0 Digital Data) service (DDAS) provided by the Company. **BellSouth SPA CNM** - FlexServ service is described in E7.4.12 following. Charges for this feature are contained in E7.5.16 following.
 - c.

The following table shows the technical specifications packages with which the optional features and functions are available.

	Available with Technical Specifications Package DA-					
	1	2	3	4	5	6
Central Office Bridging Capability	X	X	X	X	X	
BellSouth SPA CNM - FlexServ Service	X	X	X	X	X	X
Secondary Channel Capability	X	X	X	X	X	

Note 1: Effective June 30, 2021, this Service will no longer be available for purchase by new or existing customers. In addition, requests to move, add, change, or renew existing service arrangements will not be accepted. Following the expiration of a customer's existing term agreement, service will be provided on a month-to-month basis at the applicable Monthly rates until the service is discontinued. The Company currently plans to discontinue this service on or after June 30, 2024.

(N)
|
(N)

E7. SPECIAL ACCESS (A.K.A. BELLSOUTH SPA) SERVICE

E7.2 Service Descriptions for Special Access (*a.k.a. BellSouth SPA*) Service (Cont'd)

E7.2.2 Digital Services (Cont'd)

B. High Capacity (*a.k.a. BellSouth SPA High Capacity*) Service

1. Basic Channel Description

- a. A High Capacity (*a.k.a. BellSouth SPA High Capacity*) channel is a channel for the transmission of nominal 64.0 Kbps^{1, 2} or 1.544, 3.152, 6.312 or 44.736 Mbps isochronous serial data. The actual bit rate is a function of the channel interface selected. High Capacity (*a.k.a. BellSouth SPA High Capacity*) channels are provided between designated premises or between a customer designated premises and a Company Hub. (C)
- b. The customer may provide the Network Channel Terminating Equipment associated with the High Capacity (*a.k.a. BellSouth SPA High Capacity*) channel at the customer's premises. The interim program for interconnection of such equipment is set forth in Technical Reference TR-NPL-000054.

2. Technical Specifications Packages

Parameters	Package HC-				
	0	1	1C	2	3
Error-Free Seconds		X			

- a. A channel with technical specifications package HC1 will be capable of an error-free second performance of 98.75 percent over a continuous 24 hour period as measured at the 1.544 Mbps rate through a CSU equivalent which is designed to conform with the interconnection specifications contained in Technical Reference TR-NPL-000054.
- b. Further technical specifications are delineated in Technical Reference TA-TSY-000342.

3. Channel Interfaces

- a. The following channel interfaces (CIs) define the bit rates that are available for a High Capacity (*a.k.a. BellSouth SPA High Capacity*) channel:

CI	Bit Rate
DS-15 ²	1.544Mbps (DS1)
DS-31	3.152 Mbps (DS1C)
DS-44	44.736 Mbps(DS3)
DS-63	6.312 Mbps (DS2)

- b. Compatible channel interfaces are set forth in Technical Reference TA-TSY-000342

4. Optional Features and Functions

- a.

b. Transfer Arrangement

An arrangement that affords the customer an additional measure of flexibility in the use of their access channel(s). The arrangement can be utilized to transfer a leg of a Special Access (*a.k.a. BellSouth SPA*) service to either a spare or working channel that terminates in either the same or a different customer premises. A key activated or dial up control service is required to operate the transfer arrangement. A spare channel, if required, is not included as part of the option.

Note 1: Available only as a cross connect (through connection) of two 2.4, 4.8, 9.6, 19.2, 56.0 or 64.0 Kbps channels of two 1.544 Mbps facilities to a Digital Data Hub(s). The IC must provide system and channel assignment data.

Note 2: Effective June 30, 2021, 64.0 Kbps will no longer be available for purchase by new or existing customers. In addition, requests to move, add, change, or renew existing service arrangements will not be accepted. Following the expiration of a customer's existing term agreement, service will be provided on a month-to-month basis at the applicable Monthly rates until the service is discontinued. The Company currently plans to discontinue this service on or after June 30, 2024.

(C)

(C)

(N)
|
(N)

E7. SPECIAL ACCESS (A.K.A BELLSOUTH SPA) SERVICE

E7.2 Service Descriptions for Special Access (*a.k.a. BellSouth SPA*) Service (Cont'd)

E7.2.2 Digital Services (Cont'd)

B. High Capacity (a.k.a. BellSouth SPA High Capacity) Service (Cont'd)

4. Optional Features and Functions (Cont'd)

c. Channelization

(1) DS3 to DS1

An arrangement that channelizes a 44.736 Mbps channel to 28 DS1 channels.

(2) DS2 to DS1

An arrangement that channelizes a 6.312 Mbps channel to four DS1 channels.

(3) DS1C to DS1

An arrangement that channelizes a 3.152 Mbps channel to two DS1 channels.

(4) DS1 Basic Channelization System

An arrangement that channelizes a 1.544 Mbps channel to a maximum of twenty-four 64.0 Kbps channels that may be used to activate both analog and digital services, e.g., voice grade, and digital data access service. A DS1 Basic Channelization System requires a Central Office Channel Interface for each channel of lesser capacity. (D)

(5) DS0 Basic Channelization System²

An arrangement that converts a 64.0 Kbps channel to subspeeds of up to twenty 2.4 Kbps, ten 4.8 Kbps, or five 9.6 Kbps channels. A DS0 Basic Channelization System requires a Central Office Channel Interface for each channel of lesser capacity.

d. Channel Interface

(1) DS1 Level Central Office Channel Interface

An arrangement for the connection of DS1 (1.544 Mbps) channels to higher order DS3 (44.736 Mbps) services in Company central office locations.

(2) DS1 Level Customer Channel Interface

An arrangement for the connection of DS1 (1.544 Mbps) channels to higher order DS3 (44.736 Mbps) services at customer locations.

(3) DS0 Level Central Office Channel Interface²

An arrangement for the connection of VG/DS0 (2.4 - 64.0 Kbps) channels to higher order DS1 (1.544 Mbps) services in Company central office locations.

(4) Subrate Level Central Office Channel Interface²

An arrangement for the connection of subrate (2.4 - 9.6 Kbps) channels to higher order DS0 (64.0 Kbps) services in Company central office locations.

Note 1: **(DELETED)**

(T)

Note 2: Effective June 30, 2021, this Service will no longer be available for purchase by new or existing customers. In addition, requests to move, add, change, or renew existing service arrangements will not be accepted. Following the expiration of a customer's existing term agreement, service will be provided on a month-to-month basis at the applicable Monthly rates until the service is discontinued. The Company currently plans to discontinue this service on or after June 30, 2024.

E7. SPECIAL ACCESS (A.K.A. BELL SOUTH SPA) SERVICE

E7.2 Service Descriptions for Special Access (a.k.a. BellSouth SPA) Service (Cont'd)

E7.2.2 Digital Services (Cont'd)

B. High Capacity (a.k.a. BellSouth SPA High Capacity) Service (Cont'd)

4. Optional Features and Functions (Cont'd)

e. Clear Channel Capability

- (1) Clear Channel Capability (CCC) is an arrangement that alters a DS1/1.544 Mbps signal with unconstrained information bits, to meet pulse density requirements outlined in TR-NPL-000054 and TA-TSY-000342. This will allow a customer to transport an all zero octet over a DS1/1.544 Mbps High Capacity (a.k.a. BellSouth SPA DS1) channel, providing an available combined maximum 1.536 Mbps data rate. This arrangement requires the customer signal at the channel interface to conform to Bipolar with 8 Zero Substitution (B8ZS) line code as described in TR-NPL-000054 and TA-TSY-000342.
- (2) CCC is provided on DS1/1.544 Mbps High Capacity (a.k.a. BellSouth SPA DS1) channels between two customer designated premises or between a customer-designated premises and Company Hub location and is subject to the availability of facilities. This optional feature may be ordered at the same time the DS1/1.544 Mbps High Capacity (a.k.a. BellSouth SPA DS1) channel is ordered, or it may be ordered as an additional feature of an existing channel.
- (3) When providing CCC via a DS3/44.736 Mbps High Capacity (a.k.a. BellSouth SPA DS3) channel, that DS3 channel must be designated, in Company records, as having Clear Channel Capability prior to the provisioning of a DS1/1.544 Mbps High Capacity (a.k.a. BellSouth SPA DS1) channel with CCC. Customers must agree to out-of-service periods required to add this feature to; 1) an existing DS1/1.544 Mbps High Capacity (a.k.a. BellSouth SPA DS1) channel or 2) a DS3/44.736 Mbps High Capacity (a.k.a. BellSouth SPA DS3) channel which transports a DS1/1.544 Mbps High Capacity (a.k.a. BellSouth SPA DS1) channel, to be optioned for B8ZS.

f. **BellSouth SPA Customer Network Management (CNM)** - FlexServ service

(T)

BellSouth SPA CNM - FlexServ service provides the customer the ability to monitor and reconfigure High Capacity (a.k.a. BellSouth SPA High Capacity) service provided by the Company. **BellSouth SPA CNM** - FlexServ service is described in E7.4.12 following. Charges for this feature are contained in E7.5.16 following.

(T)

E7. SPECIAL ACCESS (A.K.A. BELLSOUTH SPA) SERVICE

E7.2 Service Descriptions for Special Access (a.k.a. BellSouth SPA) Service (Cont'd)

E7.2.2 Digital Services (Cont'd)

C. High Capacity (a.k.a. BellSouth SPA High Capacity) Service (Cont'd)

4. Optional Features and Functions (Cont'd)

The following table shows the technical specifications packages with which the optional features and functions are available.

	Available With Technical Specifications Package HC-				
	0	1	1C	2	3
Channelization					
DS3 to DS1				X	
DS1C to DS1			X		
DS1 Basic Channelization System		X			
DS0 Basic Channelization System ^{1, 2}		X			
Transfer Arrangement			X		
Clear Channel Capability			X		
<i>BellSouth SPA CNM</i> - FlexServ Service	X	X			

Note 1: Available only on a 64.0 Kbps DDAS (a.k.a. BellSouth SPA DS0 Digital Data) service or on a DS1 (1.544 Mbps) channel with Clear Channel Capability to a Company Hub.

Note 2: Effective June 30, 2021, this Service will no longer be available for purchase by new or existing customers. In addition, requests to move, add, change, or renew existing service arrangements will not be accepted. Following the expiration of a customer's existing term agreement, service will be provided on a month-to-month basis at the applicable Monthly rates until the service is discontinued. The Company currently plans to discontinue this service on or after June 30, 2024.

(C)

(N)
|
(N)

E7. SPECIAL ACCESS (A.K.A. BELLSOUTH SPA) SERVICE

E7.2 Service Descriptions for Special Access (*a.k.a. BellSouth SPA*) Service (Cont'd)

E7.2.3 Service Designator/Network Channel Code Conversion Table

The purpose of this table is to show the relationship between the service designator codes (e.g., VG1, MT1, etc.) and the network channel codes that are used for various administrative purposes.

Service Designator Code	Network Channel Code	
MT1	NT	
MT2	NU	
MT3	NV	
(DELETED)		(D)
(DELETED)		(D)
VG1	LB	
VG2	LC	
VG3	LD	
VG4	LE	
VG5	LF	
VG6	LG	
VG7	LH	
VG8	LJ	
VG9	LK	
VG10	LN	
VG11	LP	
VG12	LR	
(DELETED)		(D)
(DELETED)		(D)
(DELETED)		(D)
TV3	TZ	
WAL	SE	
WAL	SF	

E7. SPECIAL ACCESS (A.K.A. BELLSOUTH SPA) SERVICE

E7.2 Service Descriptions for Special Access (a.k.a. BellSouth SPA) Service (Cont'd)

E7.2.3 Service Designator/Network Channel Code Conversion Table (Cont'd)

Service Designator Code	Network Channel Code
DA1	XA
DA2	XB
DA3	XG
DA4	XH
DA5	XE
DA6	YN
HC1	HC
HC1C	HD
HC2	HE
HC3	HF

E7.2.4 Reserved for Future Use

E7.2.5 Reserved for Future Use

E7.2.6 Reserved for Future Use

E7.2.7 Reserved for Future Use

E7.2.8 Reserved for Future Use

E7.2.9 Reserved for Future Use

E7.2.10 Reserved for Future Use

E7.2.11 Reserved for Future Use

E7.2.12 Reserved for Future Use

E7.2.13 Reserved for Future Use

E7.2.14 Reserved For Future Use

(T)

E7. SPECIAL ACCESS (A.K.A. BELLSOUTH SPA) SERVICE

E7.2 Service Descriptions for Special Access (a.k.a. BellSouth SPA) Service (Cont'd)

E7.2.14 (DELETED) (Cont'd)

(D)

E7. SPECIAL ACCESS (A.K.A. BELL SOUTH SPA) SERVICE

E7.2 Service Descriptions for Special Access (a.k.a. BellSouth SPA) Service (Cont'd)

E7.2.14 (DELETED) (Cont'd)

E7.2.15 Derived Data Channel¹ (a.k.a. BellSouth SPA Derived Data Channel) Service (DDCS) (C)

A. Basic Service Description

Derived Data Channel (a.k.a. BellSouth SPA Derived Data Channel) service provides full-duplex asynchronous or synchronous data transmission utilizing data over voice and subrate multiplexing technology. DDCS (a.k.a. BellSouth SPA Derived Data Channel) provides simultaneous data and voice transmissions at 2.4 Kbps over an end user's existing two-wire local exchange facility.

The central office data/voice terminating equipment provides subrate multiplexing into a standard DS0-B interface for a group composed of a maximum of twenty Derived Data Channels (a.k.a. BellSouth SPA Derived Data Channel). The Derived Data Channel (a.k.a. BellSouth SPA Derived Data Channel) must be associated with a DS0-B Interface. An Interoffice Channel is required for interconnection of the subrate multiplexed DS0-B Interface to the IC's serving wire center when the end user's serving wire center and the IC's serving wire center are not the same. A four-wire Special Access digital facility is required to connect the DS0-B Interface to the IC's premises.

Customer Premises Equipment (CPE), provided by the end user, is required for DDCS (a.k.a. BellSouth SPA Derived Data Channel) and must be compatible with Company-provided terminating equipment at the central office.

DDCS (a.k.a. BellSouth SPA Derived Data Channel) is provided subject to the availability of appropriate network facilities and equipment and subject to the transmission limitations of the facilities and equipment used by the Company.

B. Channel Interfaces

The following Channel Interface (CI) defines the bit rate that is available with DDCS (a.k.a. BellSouth SPA Derived Data Channel).

CI	Bit Rate
2DV5.BA	2.4 Kbps, Derived Data Channel

Compatible channel interface specifications are contained in BellSouth Technical Reference Publication 73548 for data/voice multiplexing equipment and BellSouth Technical Reference Publication 73548, Addendum 1, for the DS0-B Interface. These publications are available from the Information Exchange Manager, BellSouth Telecommunications, Inc., Regional Documentations Coordinator, 20th Floor, 600, North 19th Street, Birmingham, Alabama 35203.

Note 1: Effective June 30, 2021, this Service will no longer be available for purchase by new or existing customers. In addition, requests to move, add, change, or renew existing service arrangements will not be accepted. Following the expiration of a customer's existing term agreement, service will be provided on a month-to-month basis at the applicable Monthly rates until the service is discontinued. The Company currently plans to discontinue this service on or after June 30, 2024.

(N)
|
(N)

E7. SPECIAL ACCESS (A.K.A. BELLSOUTH SPA) SERVICE

E7.2 Service Descriptions (Cont'd)

E7.2.16 SMARTRing^{®2} service (a.k.a. BellSouth Dedicated Ring)

- A. Self-healing Multi-nodal Alternate Route Topology Ring
1. SMARTRing[®] service (a.k.a. BellSouth Dedicated Ring) is a dedicated, high capacity, network designed to provide increased reliability and functionality via a self-healing ring topology between multiple customer designated locations and Company Central Offices where facilities can be made available as determined by the Company. This network consists of fiber routed through local, alternate central office, internodal and/or interoffice channel facilities that transmit DS1, DS3, STS-1, OC-3 and/or OC-12 channel services simultaneously over primary and alternate paths between customer designated locations and Company Central Offices. This ring topology will continually monitor DS1, DS3, STS-1, OC-3 and/or OC-12 service quality, detect any failure within the system, and automatically self-heal around a point of failure to ensure the flow of DS1, DS3, STS-1, OC-3, and/or OC-12 Services between locations within the network.
 2. SMARTRing[®] service (a.k.a. BellSouth Dedicated Ring) is available at OC-1, OC-3, OC-3+ OC-12, OC-48, OC-48+, OC-192 and OC-192+ capacities.
 3. OC-1 SMARTRing[®] service (a.k.a. BellSouth Dedicated Ring) is available only in Overlay Ring Arrangements riding the customer's host OC-12, OC-48, or OC-48+ SMARTRing[®] service (a.k.a. BellSouth Dedicated Ring). The OC-1 SMARTRing[®] service (a.k.a. BellSouth Dedicated Ring) shares the transport of its host SMARTRing[®] service (a.k.a. BellSouth Dedicated Ring). OC-1 SMARTRing[®] service (a.k.a. BellSouth Dedicated Ring) provides an equivalent capacity of 28 DS1s or one STS-1. When an OC-1 SMARTRing[®] service (a.k.a. BellSouth Dedicated Ring) overlays an OC-12, OC-48, or OC-48+ SMARTRing[®] service (a.k.a. BellSouth Dedicated Ring), an OC-1 channel interface is required.
 4. OC-3 SMARTRing[®] service (a.k.a. BellSouth Dedicated Ring) is available as an individual service or in an Overlay Ring Arrangement riding the customer's host OC-12, OC-48, OC-48+, OC-192 or OC-192+ SMARTRing[®] service (a.k.a. BellSouth Dedicated Ring). OC-3 SMARTRing[®] service (a.k.a. BellSouth Dedicated Ring) provides an equivalent capacity of 3 DS3s, or any combination thereof not to exceed an OC-3 capacity. Channel Interface Reallocation allows the customer to reallocate STS-1, DS3 and/or DS1 capacities to OC-3 nodes subsequent to the initial configuration of an OC-3 ring.
 5. OC-3+ SMARTRing^{®(1)} service (a.k.a. BellSouth Dedicated Ring) is available as an individual service, or in combination with OC-12 SMARTRing[®] service (a.k.a. BellSouth Dedicated Ring), or in an Overlay Ring Arrangement riding the customer's host OC-48, OC-192 or OC-192+ SMARTRing[®] service (a.k.a. BellSouth Dedicated Ring). OC-3+ SMARTRing[®] service (a.k.a. BellSouth Dedicated Ring) provides an equivalent OC-3 capacity, not to exceed 3 DS3s at each node, with a maximum ring capacity of 12 DS3s, not to exceed an OC-12 ring capacity.
 6. When a customer orders OC-3+ SMARTRing[®] service (a.k.a. BellSouth Dedicated Ring) in combination with OC-12 SMARTRing[®] service (a.k.a. BellSouth Dedicated Ring), capacity and channel interface availability at each Customer Node and Central Office Node location is determined by the size node ordered by the customer.
 7. OC-12 SMARTRing[®] service (a.k.a. BellSouth Dedicated Ring) is available as an individual service, or in combination with OC-3+ SMARTRing[®] service (a.k.a. BellSouth Dedicated Ring), or in an Overlay Ring Arrangement riding the customer's host OC-48, OC-48+, OC-192 or OC-192+ SMARTRing[®] service (a.k.a. BellSouth Dedicated Ring). OC-12 SMARTRing[®] service (a.k.a. BellSouth Dedicated Ring) provides an equivalent capacity of 12 DS3s.
 8. OC-48 SMARTRing[®] service (a.k.a. BellSouth Dedicated Ring) is available as an individual service, or in an Overlay Ring Arrangement riding the customer's host OC-192 or OC-192+ SMARTRing[®] service (a.k.a. BellSouth Dedicated Ring), or with overlaying rings in capacities of OC-1, OC-3, OC-3+ and/or OC-12. OC-48 SMARTRing[®] service (a.k.a. BellSouth Dedicated Ring) provides an equivalent capacity of 48 DS3s.

Note 1: Effective June 26, 2015, the Company will accept only disconnect orders for OC-3+ SMARTRing service (a.k.a. BellSouth SPA Dedicated Ring), including orders associated with existing service. Move, add or change orders will no longer be accepted.

Note 2: Effective on or after December 1, 2021, neither new nor existing customers will be permitted to purchase new SMARTRing Service (Service). In addition, (A) Service Payment Plans greater than 12-months in length will no longer be available; and (B) requests to move, add, change, upgrade, or downgrade existing service arrangements will not be accepted, with the following exceptions: (1) existing customers will be permitted to modify their existing Service and will be able to add new circuits to their existing Service, but will not be permitted to add new nodes in any locations; and (2) any such new circuits will be subject to the customer's existing term payment plan or term agreement for the Service to which they are added. Following the expiration of a customer's existing term agreement, Service will be provided on a month-to-month basis at the applicable Month-to-Month rates until the Service is discontinued.

Effective November 30, 2023, unless specified to the contrary in their existing Service agreements, existing customers may not renew Term Payment Plans or term agreements for Service. In addition, no move, add, or change orders of any type will be accepted.

Material previously appearing on this page now appears on page(s) 22.3 of this section.

All BellSouth marks contained herein are owned by BellSouth Intellectual Property Corporation

E7. SPECIAL ACCESS (A.K.A. BELL SOUTH SPA) SERVICE

E7.2 Service Descriptions (Cont'd)

E7.2.16 SMARTRing⁷ service (a.k.a. BellSouth Dedicated Ring) (Cont'd)

A. Self-healing Multi-nodal Alternate Route Topology Ring (Cont'd)

- 9. OC-48+ SMARTRing[®] service (a.k.a. BellSouth Dedicated Ring) is available as an individual bi-directional service, or in an Overlay Ring Arrangement riding the customer's host OC-192 SMARTRing[®] service (a.k.a. BellSouth Dedicated Ring), or with overlaying rings in capacities of OC-1, and/or OC-3. It provides equivalent capacity of 24 DS3s between consecutive node locations on the ring. The maximum capacity of the OC-48+ SMARTRing[®] service (a.k.a. BellSouth Dedicated Ring) is determined by the number of Customer and Central Office nodes on the ring. (M1)
- 10. OC-192 SMARTRing[®] service (a.k.a. BellSouth Dedicated Ring) is available as an individual service, or with overlaying rings in capacities of OC-3, OC-3+, OC-12, OC-48 and /or OC-48+. OC-192 SMARTRing[®] service (a.k.a. BellSouth Dedicated Ring) provides an equivalent capacity of 192 DS3s. (M1)
- 11. OC-192+ SMARTRing[®] service (a.k.a. BellSouth Dedicated Ring) is available as an individual bi-directional service, or with overlaying rings in capacities of OC-3, OC-3+, OC-12 and /or OC-48. It provides equivalent capacity of 96 DS3s between consecutive node locations on the ring. The maximum capacity of the OC-192+ SMARTRing[®] service (a.k.a. BellSouth Dedicated Ring) is determined by the number of Customer and Central Office nodes on the ring. (M1)
- 12. SMARTRing service (a.k.a. BellSouth Dedicated Ring) Channel Interfaces are available as follows:

<u>Channel Interfaces</u>	<u>Nodes</u>								
	<u>OC-1</u>	<u>OC-3</u>	<u>OC-3+</u>	<u>OC-12</u>	<u>OC-48</u>	<u>OC-48+</u>	<u>OC-192</u>	<u>OC-192+</u>	
DS1	Yes	Yes	Yes	No ¹	No ¹	No ¹	No ¹	No ¹	
DS3	No	Yes	Yes	Yes	Yes	Yes	Yes	Yes	
STS-1	Yes	Yes	Yes	Yes	Yes	Yes	Yes	Yes	
OC-1 ²	No	No	No	Yes	Yes	Yes	Yes	Yes	
OC-3	No	No	No	Yes	Yes	Yes	Yes	Yes	
OC-12	No	No	No	No	Yes	Yes	Yes	Yes	
28 DS1 Channel System (DS3)	No	Yes	Yes	Yes	Yes	Yes	Yes	Yes	
28 DS1 Channel System (STS-1)	No	Yes	Yes	Yes	Yes	Yes	Yes	Yes	
1000 Mbps	No	No	No	No	Yes ³	Yes ³	Yes	Yes	
100 Mbps BellSouth Metro Ethernet ⁶ Backbone ⁴	No	No	No	Yes	Yes	Yes	Yes	Yes	
1000 Mbps BellSouth Metro Ethernet ⁶ Backbone	No	No	No	No	Yes	Yes	Yes	Yes	
Fractional 1000 Mbps at 150 Mbps, 300 Mbps or 450 Mbps BellSouth Metro Ethernet ⁶ Backbone ⁵	No	Yes	Yes	Yes	Yes	Yes	Yes	Yes	
Fractional 1000 Mbps at 600 Mbps BellSouth Metro Ethernet ⁶ Backbone ⁵	No	No	No	No	Yes	Yes	Yes	Yes	

- Note 1:** DS1 interfaces are available via OC-1, OC-3, and OC-3+ Overlay Ring Arrangements or 28 DS1 Channel Systems only.
 - Note 2:** OC-1 interfaces are only available for use with OC-1 Overlay Ring Arrangements.
 - Note 3:** 1000 Mbps interfaces are only available for rings installed after October 30, 2003. 1000 Mbps transport channel interfaces do not contain any monitoring capability above the physical layer.
 - Note 4:** 100 Mbps BellSouth Metro Ethernet Backbone interfaces are further defined regarding the number of STS-1s utilized in conjunction with the interface.
 - Note 5:** Interface availability is based on equipment capability.
 - Note 6:** Effective on or after August 22, 2021, this Service will no longer be available for purchase by new or existing customers. In addition, requests to move, add, change, or renew existing service arrangements will not be accepted. Following the expiration of a customer's existing term agreement, service will be provided on a month-to-month basis at the applicable Monthly rates until the service is discontinued. The Company currently plans to discontinue this service on or after March 31, 2023.
 - Note 7:** Effective on or after December 1, 2021, neither new nor existing customers will be permitted to purchase new SMARTRing Service (Service). In addition, (A) Service Payment Plans greater than 12-months in length will no longer be available; and (B) requests to move, add, change, upgrade, or downgrade existing service arrangements will not be accepted, with the following exceptions: (1) existing customers will be permitted to modify their existing Service and will be able to add new circuits to their existing Service, but will not be permitted to add new nodes in any locations; and (2) any such new circuits will be subject to the customer's existing term payment plan or term agreement for the Service to which they are added. Following the expiration of a customer's existing term agreement, Service will be provided on a month-to-month basis at the applicable Month-to-Month rates until the Service is discontinued. (N)
- Effective November 30, 2023, unless specified to the contrary in their existing Service agreements, existing customers may not renew Term Payment Plans or term agreements for Service. In addition, no move, add, or change orders of any type will be accepted. (N)

M1 Material appearing on this page previously appeared on page(s) 22.2 of this section.
 M2 Material previously appearing on this page now appears on page(s) 22.4 of this section.

E7. SPECIAL ACCESS (A.K.A. BELLSOUTH SPA) SERVICE

E7.2 Service Descriptions (Cont'd)

E7.2.16 SMARTRing¹ service (a.k.a. BellSouth Dedicated Ring) (Cont'd) (C)

A. Self-healing Multi-nodal Alternate Route Topology Ring (Cont'd)

13. SMARTRing service (a.k.a. BellSouth Dedicated Ring) Overlay Ring Arrangements are available as follows: (M1)

Overlying SMARTRing service (a.k.a. BellSouth Dedicated Ring)	OC-12	OC-48	OC-48+	OC-192	OC-192+
OC-1	X	X	X	X	X
OC-3	X	X	X	X	X
OC-3+		X	X	X	X
OC-12		X	X	X	X
OC-48				X	X
OC-48+					X

14. SMARTRing service (a.k.a. BellSouth Dedicated Ring) is connectible at Company Central Offices to any 44.736 Mbps and/or 1.544 Mbps services as provided in Section E7. of this Tariff. Rates and charges for such other services are as set forth in the applicable sections of this tariff for such other services. (M1)

15. Shared Network Arrangements will not be provided with SMARTRing service (a.k.a. BellSouth Dedicated Ring) at the ring level. Shared Network Arrangements as defined in E2.6 preceding apply to DS1 channel interfaces only. (M1)

The customer must provide suitable floor space, controlled environment, and source of non-switched suitable power to support this service.

16. Where the customer provides two separate entrance facility cable routes for SMARTRing service (a.k.a. BellSouth Dedicated Ring), the primary and alternate entrance facilities will be separate and will enter the customer node over such different routes. When the customer requests a connection at a Customer Node via two local channels and Company facilities do not exist for the second Local Channel, the Company may provide an equivalent second Local Channel via an existing alternate route. When facilities become available for the second Local Channel, the Company may rearrange the alternate route at any time. (M1)

17. When the distance between nodes on a SMARTRing service (a.k.a. BellSouth SPA Dedicated Ring) is such that optical signal regeneration is required, then regeneration equipment will be provided at no additional charge to the customer to assure proper operation of the service. In some cases regeneration will be provided via SONET Add/Drop equipment called a Regeneration Node. A Regeneration Node does not contain the capability to add or drop services. Accordingly, BellSouth SPA CNM - FlexServ service may not be ordered with a Regeneration Node, however, a customer may monitor a Regeneration Node via the BellSouth SPA CNM - FlexServ service Surveillance option when a customer has established surveillance for a ring. Regeneration Node Surveillance is provided as a part of the charges associated with the customer's ring level BellSouth SPA CNM - FlexServ service Surveillance. Regeneration Node and Regeneration Node Surveillance, as applicable, will appear on a customer's records as non-rated USOC(s), as follows:

Regeneration Node, all ring capacities, non-rated	USOC SHNRD
Regeneration Node Surveillance, all ring capacities, non-rated	SHNRS

- Note 1:** Effective on or after December 1, 2021, neither new nor existing customers will be permitted to purchase new SMARTRing Service (Service). In addition, (A) Service Payment Plans greater than 12-months in length will no longer be available; and (B) requests to move, add, change, upgrade, or downgrade existing service arrangements will not be accepted, with the following exceptions: (1) existing customers will be permitted to modify their existing Service and will be able to add new circuits to their existing Service, but will not be permitted to add new nodes in any locations; and (2) any such new circuits will be subject to the customer's existing term payment plan or term agreement for the Service to which they are added. Following the expiration of a customer's existing term agreement, Service will be provided on a month-to-month basis at the applicable Month-to-Month rates until the Service is discontinued. (N)

Effective November 30, 2023, unless specified to the contrary in their existing Service agreements, existing customers may not renew Term Payment Plans or term agreements for Service. In addition, no move, add, or change orders of any type will be accepted. (N)

M1 Material appearing on this page previously appeared on page(s) 22.3 of this section.

M2 Material previously appearing on this page now appears on page(s) 23 of this section.

E7. SPECIAL ACCESS (A.K.A. BELLSOUTH SPA) SERVICE

E7.2 Service Descriptions (Cont'd)

E7.2.16 SMARTRing¹ service (a.k.a. BellSouth Dedicated Ring) (Cont'd)

A. Self-healing Multi-nodal Alternate Route Topology Ring (Cont'd)

18. Effective February 16, 2007, Shared Node Interconnection is available, based on equipment capability, whereby two SMARTRing service arrangements belonging to the same customer may share a node in a central office that is common to both rings. Shared Node Interconnection capability is available based on equipment capability. With Shared Node Interconnection, one of the rings (i.e., the larger capacity ring) is considered the Primary Ring and the other ring is considered the Secondary Ring. Primary Rings may be an OC-12, OC-48 or an OC-192 ring. A Secondary Ring is always a lower capacity ring than that of the Primary Ring. The various Shared Node Interconnection service arrangements that are available are as follows:

Shared Node Interconnection Primary Ring Capacity	Shared Node Interconnection Secondary Ring Capacity Available For Use With Primary Rings			
	OC-3	OC-12	OC-48	OC-48+
OC-12	X			
OC-48	X	X		
OC-192	X	X	X	X

With Shared Node Interconnection, the Primary Ring shall have a Central Office Node and the Secondary Ring shall have a Shared Node Interconnection Central Office Node in the central office associated with the ring interconnection. For the Secondary Ring, a Shared Node Interconnection Central Office Node is considered toward meeting the three node minimum requirement for the Secondary Ring. This shared node will utilize capacity of the Primary Ring node, based on the size of the Secondary Ring, and will count toward the capacity the customer has available at the location. Should the customer require more capacity at a shared node central office location than is available on the Primary Ring node, then additional billable service components will be required.

Only one Shared Node Interconnection arrangement is available for an individual Central Office Node on a Primary Ring.

Reconfiguration is not allowed at central office nodes that are configured for Shared Node Interconnection.

B. Technical Specifications Packages

- The compatibility requirements, technical specifications, and generic requirements for SMARTRing service (a.k.a. BellSouth Dedicated Ring) terminated at the customers designated locations are referenced in Technical Reference ANSI T1.404-1994, ANSI T1.403-1989 and ANSI T1.105-1991.
- DS3 interface combinations and technical specifications are referenced in Bellcore TR-INS-000342.
- DS1 interface combinations and technical specifications are referenced in Bellcore TR-NPL-000054.
- STS-1, OC-1, OC-3, and OC-12 interface combinations and technical specifications are referenced in BellSouth Telecommunications, Inc. Technical Reference TR-73582.
- These self-healing multi-nodal DS3 high capacity (a.k.a. BellSouth SPA DS3) service channels have a long term performance objective of 99.5 percent error-free seconds and a severely errored second (SES) objective of less than 0.009 percent SES when the circuit is available. Self-healing multi-nodal DS1 high capacity (a.k.a. BellSouth SPA DS1) service channels have a long term performance objective of 99.95 percent error-free seconds.

E7.2.17 Reserved for Future Use

Note 1: Effective on or after December 1, 2021, neither new nor existing customers will be permitted to purchase new SMARTRing Service (Service). In addition, (A) Service Payment Plans greater than 12-months in length will no longer be available; and (B) requests to move, add, change, upgrade, or downgrade existing service arrangements will not be accepted, with the following exceptions: (1) existing customers will be permitted to modify their existing Service and will be able to add new circuits to their existing Service, but will not be permitted to add new nodes in any locations; and (2) any such new circuits will be subject to the customer's existing term payment plan or term agreement for the Service to which they are added. Following the expiration of a customer's existing term agreement, Service will be provided on a month-to-month basis at the applicable Month-to-Month rates until the Service is discontinued.

Effective November 30, 2023, unless specified to the contrary in their existing Service agreements, existing customers may not renew Term Payment Plans or term agreements for Service. In addition, no move, add, or change orders of any type will be accepted.

E7. SPECIAL ACCESS (A.K.A. BELLSOUTH SPA) SERVICE

E7.2 Service Descriptions (Cont'd)

E7.2.18 BellSouth Metro Ethernet Service²

(C)

- A. BellSouth Metro Ethernet service is a high-speed packet transport that is based on Ethernet transmission parameters. BellSouth Metro Ethernet service provides various transport capabilities that range from 2 Mbps through 1 Gbps with capabilities for basic, premium and virtual arrangements that may be used to meet individual customer needs.
- B. BellSouth Metro Ethernet service signals meet IEEE 802.3, 802.3u, or 802.3z standards. BellSouth Metro Ethernet service also uses 802.1Q VLAN tagging and stacking for certain service configurations contained herein. Technical requirements for interfaces with customer premises equipment (CPE) are contained in ANSI/IEEE 802.3-2002 Specifications.
- C. BellSouth Metro Ethernet service interface specifications are set forth in BellSouth Technical Reference TR-73632. Technical limitations associated with provisioning 2 Mbps, 4 Mbps and 8 Mbps BellSouth Metro Ethernet Connections based upon distance from the customer's premises to serving wire center and equipment configurations exist and are also set forth in TR-73632.
- D. The rates and charges set forth in E7.5.22 following for BellSouth Metro Ethernet service provide for the furnishing of service in certain metropolitan areas where suitable Company facilities are available. In locations where BellSouth Metro Ethernet service is not available, special construction charges may apply.
- E. A LAN (local area network) is a communications network spanning a limited geographical area. A LAN connects computers and other peripheral equipment for data communications purposes within a building or campus environment.
- F. A VLAN (virtual local area network) is a logical grouping of Metro Ethernet connections that allows data transmission between such connections to occur as if all connections are on the same physical LAN.
- G. Metro Ethernet is a service where Local Area Networks (LANs) send bi-directional Ethernet traffic to other LANs on an Ethernet Wide Area Network (WAN). Ethernet is one of the most widely deployed LAN/WAN standards. BellSouth Metro Ethernet service supports IEEE Standard 802.3, 802.3u and 802.3z transmission standards.
- H. A Metro Ethernet Customer Network is defined as the set of interconnected Metro Ethernet connections assigned to the same VLAN within the BellSouth core network. Premium Connections that include the Q-Forwarding optional feature described in O. following and Virtual Connections that include the VLAN Aggregation optional feature described in P. following may be part of more than one Metro Ethernet Customer Network.
- I. A Basic BellSouth Metro Ethernet service Connection provides 2 Mbps, 4 Mbps, 8 Mbps, 10 Mbps, 100 Mbps and 1 Gbps Ethernet capabilities that are a part of a BellSouth Metro Ethernet service network within a metropolitan area. Basic BellSouth Metro Ethernet service is a best effort service with service capabilities that are affected by overall traffic on the Basic BellSouth Metro Ethernet service network and is suitable for data transmission only.

A Basic BellSouth Metro Ethernet service connection operating at any of these speeds is capable of interconnecting with other Basic BellSouth Metro Ethernet service Connections that are operating at any of these speeds in the same metropolitan area.

A Basic BellSouth Metro Ethernet service connection provides data channel transport that connects customer premises¹ that are 10 miles or less in distance from the BellSouth Metro Ethernet service wire center associated with the Basic BellSouth Metro Ethernet service Connection. Customer locations¹ greater than 10 miles from the Basic BellSouth Metro Ethernet service wire center also require BellSouth Metro Ethernet service Additional Mileage charges.

Note 1: And as alternatively set forth in E7.4.32.A.5. *and 6.* following.

Note 2: Effective on or after August 22, 2021, this Service will no longer be available for purchase by new or existing customers. In addition, requests to move, add, change, or renew existing service arrangements will not be accepted. Following the expiration of a customer's existing term agreement, service will be provided on a month-to-month basis at the applicable Monthly rates until the service is discontinued. The Company currently plans to discontinue this service on or after March 31, 2023.

(N)

(N)

E7. SPECIAL ACCESS (A.K.A. BELL SOUTH SPA) SERVICE

E7.2 Service Descriptions (Cont'd)

E7.2.18 BellSouth Metro Ethernet Service (Cont'd)³

(C)

- J. A Premium BellSouth Metro Ethernet service Connection provides 2 Mbps, 4 Mbps, 8 Mbps, 10 Mbps, 20 Mbps, 50 Mbps, 100 Mbps, 250 Mbps, 500 Mbps and 900 Mbps Ethernet capabilities that are a part of a BellSouth Metro Ethernet service network within a metropolitan area. Premium BellSouth Metro Ethernet service provides the ability to order Ethernet Service with improved service characteristics to meet customer needs regarding the assurance of bandwidth availability.

Premium BellSouth Metro Ethernet service provides customer capabilities to assure service characteristics via ordering a Committed Bandwidth (CBW). A CBW is the minimum bandwidth across the BellSouth Metro Ethernet service network within a metropolitan area between a customer’s Premium BellSouth Metro Ethernet service locations.

Premium BellSouth Metro Ethernet service Connections are available with “Fixed” and “Burst” capabilities unless specified otherwise¹. With the Fixed arrangement, Premium BellSouth Metro Ethernet service Connections will have the bandwidth ordered (e.g., 10 Mbps) available across the BellSouth Metro Ethernet service network. With the Burst arrangement, Premium BellSouth Metro Ethernet service Connections will have the ability to send burst of data above their CBW rate, if network capacity *and facilities are* available. For example, a 10 Mbps, a 20 Mbps and a 50 Mbps Connection may Burst up to 100 Mbps, while a 100 Mbps, a 250 Mbps and a 500 Mbps Connection may Burst up to 1 Gbps.

A Premium BellSouth Metro Ethernet service Connection operating at any of these speeds is capable of interconnecting with other Premium BellSouth Metro Ethernet service Connections that are operating at any of these speeds in the same metropolitan area.

A Premium BellSouth Metro Ethernet service Connection provides data channel transport that connects customer premises² that are 10 miles or less in distance from the BellSouth Metro Ethernet service wire center associated with the Premium BellSouth Metro Ethernet service Connection. Customer locations² greater than 10 miles from the Premium BellSouth Metro Ethernet service wire center also require BellSouth Metro Ethernet service Additional Mileage charges.

- Note 1:** Premium Connections at 2 Mbps, 4 Mbps, 8 Mbps and 900 Mbps are available only as Fixed arrangements (i.e., “Burst” capability is not available).
- Note 2:** And is alternatively set forth in E7.4.32.A.5. following.
- Note 3:** Effective on or after August 22, 2021, this Service will no longer be available for purchase by new or existing customers. In addition, requests to move, add, change, or renew existing service arrangements will not be accepted. Following the expiration of a customer's existing term agreement, service will be provided on a month-to-month basis at the applicable Monthly rates until the service is discontinued. The Company currently plans to discontinue this service on or after March 31, 2023.

(N)
 |
 (N)

E7. SPECIAL ACCESS (A.K.A. BELLSOUTH SPA) SERVICE

E7.2 Service Descriptions (Cont'd)

E7.2.18 BellSouth Metro Ethernet Service (Cont'd)²

(C)

K.

- L. A Virtual BellSouth Metro Ethernet Service Connection provides 2 Mbps, 4 Mbps, 8 Mbps, 10 Mbps, 20 Mbps, 50 Mbps, 80 Mbps, 100 Mbps, 200 Mbps, 300 Mbps, 450 Mbps, 600 Mbps, 750 Mbps and 900 Mbps Ethernet capabilities that are a part of a BellSouth Metro Ethernet Service network within a metropolitan area. Virtual BellSouth Metro Ethernet Service provides the ability to order Ethernet Service where a single customer connection can support multiple applications with varying Quality of Service (QoS) features and Classes of Service.

Virtual BellSouth Metro Ethernet Service provides customer capabilities to support different Classes of Service (CoS) (i.e., Real-Time, Interactive, Business Critical and Best Effort as described in E7.2.18.T) over the same Connection and offers customers increased flexibility to match bandwidth to their real needs for voice/data/video applications on each Connection. The customer orders the percentage of their Virtual BellSouth Metro Ethernet Service Connection bandwidth that will be allocated for each class of service.

For each Virtual Connection, the customer's bandwidth will be limited to the fixed speed associated with each CoS level specified in the CoS profile selected for the Virtual Connection.

A Virtual BellSouth Metro Ethernet Service Connection operating at any of these speeds is capable of interconnecting with other Virtual BellSouth Metro Ethernet Service Connections that are operating at any of these speeds in the same metropolitan area.

A Virtual BellSouth Metro Ethernet Service Connection provides data channel transport that connects customer premises¹ that are 10 miles or less in distance from the BellSouth Metro Ethernet Service wire center associated with the Virtual BellSouth Metro Ethernet Service Connection. Customer locations¹ greater than 10 miles from the Virtual BellSouth Metro Ethernet Service wire center also require BellSouth Metro Ethernet Service Additional Mileage charges.

Note 1: And as alternatively set forth in E7.4.32.A.5. *and 6.* following.

Note 2: Effective on or after August 22, 2021, this Service will no longer be available for purchase by new or existing customers. In addition, requests to move, add, change, or renew existing service arrangements will not be accepted. Following the expiration of a customer's existing term agreement, service will be provided on a month-to-month basis at the applicable Monthly rates until the service is discontinued. The Company currently plans to discontinue this service on or after March 31, 2023.

(N)
|
(N)

E7. SPECIAL ACCESS (A.K.A. BELLSOUTH SPA) SERVICE

E7.2 Service Descriptions (Cont'd)

E7.2.18 BellSouth Metro Ethernet Service (Cont'd)²

(C)

- M.** BellSouth Metro Ethernet service Additional Mileage charges associated with a BellSouth Metro Ethernet service Connection apply when the total distance from the customer premises¹ to the BellSouth Metro Ethernet service wire center associated with the service serving the customer premises¹ is greater than 10 miles in length. The additional mileage is measured in airline miles from the customer premises¹ to the BellSouth Metro Ethernet service wire center associated with the BellSouth Metro Ethernet service. Fractions of miles will be considered as a whole mile.

BellSouth Metro Ethernet service Additional Mileage charges apply to Basic, Premium and Virtual BellSouth Metro Ethernet service based on the service's speed and the total distance associated with the data channel. The BellSouth Metro Ethernet service Additional Mileage Charge is based on the mileage band the total data channel mileage falls into. For example, a data channel that is 30 miles in length would be charged the additional mileage rate for the greater than 25 mile through 35 mile band.

- N.** Priority Plus is an optional feature available to customers with Premium BellSouth Metro Ethernet service. Priority Plus provides the customer with the ability to prioritize their traffic in accordance with a predefined hardware queue model approach. With this option, customers will assign priority values to their data and higher-priority data will be transmitted first. Priority Plus service traffic is limited to a small subset of the total Committed Bandwidth (CBW) traffic and is marked for expedited handling within the Metro Ethernet Service. Customers that desire Priority Plus must establish it for all of their Premium BellSouth Metro Ethernet service Connections within that Metro Ethernet Customer Network.

- O.** Q-Forwarding is an optional feature available to customers with Premium BellSouth Metro Ethernet service. Q-Forwarding provides VLAN aggregation across a common physical connection. This feature supports customer aggregation of traffic from multiple Metro Ethernet Customer Networks (referred to as VLANS). This aggregated traffic can be transported back to a central location and across a common Metro Ethernet Service Connection (referred to as the "aggregation" connection). Q-Forwarding utilizes IEEE 802.1Q VLAN Tagging procedures.

While Q-Forwarding is available with BellSouth Premium Metro Ethernet Connections at 2 Mbps, 4 Mbps and 8 Mbps, this feature is subject to technical limitations set forth in Technical Reference 73632 when used with these speed connections.

With Q-Forwarding, special technical considerations set forth in Technical Reference 73632 must be taken into account to determine the customer's CBW across their BellSouth Metro Ethernet Network.

The Q-Forwarding Service Establishment Charge is a charge to provision a Premium Metro Ethernet Connection with the Q-Forwarding feature and identify it as an "aggregation" connection.

The Q-Forwarding Network Assignment Charge is a charge to provision each Metro Ethernet Customer Network to the Q-Forwarding "aggregation" connection. The Q-Forwarding Network Assignment Charge applies for each VLAN connected to the Q-Forwarding "aggregation" connection.

- P.** VLAN Aggregation is an optional feature available to customers with Virtual BellSouth Metro Ethernet Service. VLAN Aggregation provides VLAN aggregation across a common physical connection. This feature supports customer aggregation of traffic from multiple Metro Ethernet Customer Networks (referred to as VLANS) comprised of Virtual Connections. This aggregated traffic can be transported back to a central location and across a common Virtual Metro Ethernet Service Connection (referred to as the "aggregation" connection). VLAN Aggregation utilizes IEEE 802.1Q VLAN Tagging procedures.

While VLAN Aggregation is available with BellSouth Virtual Metro Ethernet Connections at 2 Mbps, 4 Mbps and 8 Mbps, this feature is subject to technical limitations set forth in Technical Reference 73632 when used with these speed connections.

The VLAN Aggregation Service Establishment Charge is a charge to provision a Virtual Metro Ethernet Connection with this feature and identify it as an "aggregation" connection.

The VLAN Aggregation Network Assignment Charge is a charge to provision each Virtual Ethernet Customer Network to the "aggregation" connection. The VLAN Aggregation Network Assignment Charge applies for each VLAN connected to the "aggregation" connection.

Note 1: And as alternatively set forth in E7.4.32.A.5. and 6. following.

Note 2: Effective on or after August 22, 2021, this Service will no longer be available for purchase by new or existing customers. In addition, requests to move, add, change, or renew existing service arrangements will not be accepted. Following the expiration of a customer's existing term agreement, service will be provided on a month-to-month basis at the applicable Monthly rates until the service is discontinued. The Company currently plans to discontinue this service on or after March 31, 2023.

(N)
|
(N)

E7. SPECIAL ACCESS (A.K.A. BELLSOUTH SPA) SERVICE

E7.2 Service Descriptions (Cont'd)

E7.2.18 BellSouth Metro Ethernet Service (Cont'd)¹

(C)

- Q.** Customer Network Management (CNM) - Metro Ethernet Reporting is an optional feature available to customers with Premium or Virtual BellSouth Metro Ethernet service. CNM - Metro Ethernet Reporting provides customers a view into their BellSouth Metro Ethernet service network via the use of a web interface and security card. CNM - Metro Ethernet Reporting provides alarm surveillance, service level agreement reporting and performance reporting for the various network components that comprise the customer's BellSouth Metro Ethernet service network. This feature is only available to customers purchasing Premium or Virtual BellSouth Metro Ethernet service.

Customers who subscribe to Metro Ethernet Reporting must monitor their entire BellSouth Metro Ethernet Network. The CNM - Metro Ethernet Reporting Charge is applicable for each Premium or Virtual Metro Ethernet Service Connection.

The CNM - Metro Ethernet Reporting Service Establishment Charge is a nonrecurring charge that applies to initially establish a new Metro Ethernet Service customer account. A customer with an existing CNM - Metro Ethernet Reporting customer account from another BellSouth jurisdiction may re-use that customer account.

All customers purchasing CNM - Metro Ethernet Reporting must have a web interface that will allow the customer to access and monitor their network via the web. Each web interface provides for one concurrent access. Additional concurrent accesses will require additional web interfaces. An initial web interface (Web Interface Charge - First) is provided with the initial establishment of a customer account. A monthly charge and a nonrecurring charge are applicable for each additional web interface requested for a customer account (Web Interface Charge – Each Additional).

A security card is required to access a web interface. Each security card can only be used for a single concurrent access and can be associated with only one web interface. A Security Card Charge will apply for the initial and additional cards requested and for the issuance of additional cards to replace lost, damaged or expired cards. A nonrecurring charge is applicable per security card requested.

Effective November 1, 2008, a security card will not be required to access a web interface. Security will be provided using a customer user identification code and password. New orders for a security card will not be accepted. Customers may continue to use their existing security cards but may not order new cards.

- R.** BellSouth Metro Ethernet service Customer networks comprised of Premium Connections or Virtual Connections with CNM - Metro Ethernet Reporting are provided Service Level Agreements (SLAs) for the Company's repair and performance commitments for this service. Credits are provided for missed commitments on such service. The specific SLA commitments and credits applicable are set forth in E7.4.32.C. following for Premium Connections and in E7.4.32.D. for Virtual Connections.
- S.** Subsequent to its initial installation, a customer may request to reconfigure or change a BellSouth Metro Ethernet service Connection. The Service Reconfiguration Charge or System Reconfiguration Charge will be the nonrecurring charge applicable for such a request; the appropriate nonrecurring charge will be based upon the reconfiguration or change requested, as specifically described and set forth in E7.4.32 following.
- T.** For each Virtual BellSouth Metro Ethernet Connection the customer must decide the mix of applications that will be supported on that Connection, the CoS mix that Virtual Connection must support, and the percentage of bandwidth to be assigned for each CoS (i.e., build a CoS profile for each Virtual Connection). The customer's bandwidth will be limited to the fixed speed associated with each CoS level. Therefore, total bandwidth available to support transmission of a specific CoS will depend upon the size of the customer's Connection and the specific CoS percentage the customer selected for that Connection.

A customer may request a single CoS or up to four CoS to build the CoS Profile for a Virtual Connection. The customer determines the percentage bandwidth each CoS selected should be of the total Virtual Connection's bandwidth. The sum of the percentages for each CoS selected for a Virtual Connection must equal 100%. Additionally, the combined CoS bandwidth percentages selected in a customer's CoS Profile for Real-Time CoS plus Interactive CoS may not exceed 50%, except where the customer selects the 70% Real-Time CoS bandwidth percentage and has no Interactive traffic.

A customer may select different CoS profiles for different Virtual Connections that share the same network VLAN, or Virtual Connection network arrangement. However, technical limitations exist as discussed in TR-73632 that limit the total number of different CoS profiles that can be utilized in a single Virtual Connection network arrangement.

Note 1: Effective on or after August 22, 2021, this Service will no longer be available for purchase by new or existing customers. In addition, requests to move, add, change, or renew existing service arrangements will not be accepted. Following the expiration of a customer's existing term agreement, service will be provided on a month-to-month basis at the applicable Monthly rates until the service is discontinued. The Company currently plans to discontinue this service on or after March 31, 2023.

(N)

(N)

E7. SPECIAL ACCESS (A.K.A. BELLSOUTH SPA) SERVICE

E7.2 Service Descriptions (Cont'd)

E7.2.18 BellSouth Metro Ethernet Service (Cont'd)²

(C)

T. (Cont'd)

The CoS and percentage bandwidth selected for a Virtual Connection will define the applications that can be supported and its Quality of Service (QoS) attributes such as traffic priority, latency, packet loss rate, etc. QoS attributes are defined for each CoS. Each Virtual Connection will support Ethernet traffic representing one or more applications and CoS. Virtual Connections support the four following CoS:

- Real-Time¹: This CoS supports VoIP applications. The Real-Time CoS is supported by a low latency queue. The Low Latency Queuing (LLQ) feature in the Ethernet network is used for support of the Real-Time CoS.
- Interactive¹: This CoS supports interactive Video applications. The Interactive CoS is policed to a maximum bandwidth.
- Business Critical: This CoS supports mission-critical business data applications. These applications tend to be data specific and may include medical imaging, electronic funds transfer, medical records transfer, etc.
- Best Effort: This CoS is the default CoS for all other traffic that is not defined as Business Critical, Real-Time or Interactive. Traffic that does not match the other CoS will be mapped as Best Effort. Traffic with the Best Effort CoS will have the lowest priority on the network and will support lower priority data applications, such as email and file transfer protocol (FTP).

Each customer packet from a Virtual Connection will be classified and assigned to a specific CoS by methods identified in TR-73632.

Note 1: The combined CoS bandwidth percentages selected in a customer's Virtual Connection CoS profile for Real-Time CoS plus Interactive CoS may not exceed 50%, except where the customer selects the 70% Real-Time CoS bandwidth percentage and has no Interactive traffic.

Note 2: Effective on or after August 22, 2021, this Service will no longer be available for purchase by new or existing customers. In addition, requests to move, add, change, or renew existing service arrangements will not be accepted. Following the expiration of a customer's existing term agreement, service will be provided on a month-to-month basis at the applicable Monthly rates until the service is discontinued. The Company currently plans to discontinue this service on or after March 31, 2023.

(N)
|
(N)

E7. SPECIAL ACCESS (A.K.A. BELL SOUTH SPA) SERVICE

E7.2 Service Descriptions (Cont'd)

E7.2.18 BellSouth Metro Ethernet Service (Cont'd)²

(C)

- U. Automatic Protection Switching (APS) is an optional feature available, except as specified otherwise herein, to customers with a Basic, Premium or Virtual BellSouth Metro Ethernet Service Connection of 10 Mbps or higher¹. The APS feature provides customers with the option of having data channel (i.e., facilities from the customer premises to the BellSouth Metro Ethernet Service wire center) survivability through the use of a secondary transport path that is diverse from the path provided with their primary Metro Ethernet Connection. This secondary transport path (i.e., data channel) is provided for a specific Metro Ethernet Connection (i.e., the primary) with the selection of the APS feature which then provides the customer with complete path protection. However, APS is not available for a 2 Mbps, 4 Mbps or 8 Mbps Connection.

With APS, the primary Metro Ethernet Connection's data channel is monitored for threshold violations or path failures with a fail-over to the secondary data channel path provided via the APS feature. The APS data channel is checked periodically to ensure its availability if a failure of the primary Metro Ethernet Connection's data channel occurs.

APS may be ordered as a structurally diverse transport path (Structural Protection) or a route diverse transport path (Route Protection).

Structural Protection APS is defined as the APS facility and the primary Metro Ethernet Connection facility being in separate sheaths in separate structures located along the same route (e.g., underground/underground, buried/underground, aerial/underground, aerial/buried, buried/buried, and aerial/aerial), or along different routes at the Telephone Company's discretion

Route Protection APS is defined as the APS facility being in a separate sheath within alternate underground, aerial or direct buried structures that are run along separate physical paths from the facilities associated with the primary Metro Ethernet Connection. No precise distance separation is specified between the paths; although the separation is sufficient to preclude one disruptive event from affecting both routes.

The APS feature is billed based upon the actual total route miles in a customer's specific Structural Protection APS or Route Protection APS design as determined by the Telephone Company. The term "route miles" is defined for this application to be the actual physical distance or length (not airline mileage), rounded up to the next whole mile, of the unique APS facility designed for each individual customer premises. Total route miles are measured between the customer premises and its serving wire center, plus route miles between the serving wire center and any intermittent wire centers in the path designed to reach the BellSouth Metro Ethernet wire center associated with the primary Metro Ethernet Connection (i.e., the wire center where the BellSouth Metro Ethernet switching equipment is located).

The APS rate element provides the alternate data channel transport and APS equipment in the BellSouth Metro Ethernet Service wire center associated with the primary Metro Ethernet Connection. Actual total route mileage for the customer's APS design is determined from a Service Inquiry. The route mileage determined from this Telephone Company Service Inquiry is used for billing purposes and is the sole determinant of such mileage (i.e., not subject to dispute).

- V. BellSouth Metro Ethernet Service Independent Company (ICO) Trunk Connection

Provides interconnection between BellSouth's Ethernet network and the Ethernet network of an Independent Telephone Company. A BellSouth Metro Ethernet Service ICO Trunk Connection provides data channel transport for connections that are 10 airline miles or less in distance from the BellSouth Metro Ethernet Service ICO Trunk Connection wire center to the meet-point with the Independent Company. Meet-point locations greater than 10 airline miles from the BellSouth Metro Ethernet Service ICO Trunk Connection wire center also require BellSouth Metro Ethernet Service ICO Trunk Additional Mileage charges.

- W. BellSouth Metro Ethernet Service Independent Company (ICO) Trunk Additional Mileage Charges

Additional mileage charges associated with a BellSouth Metro Ethernet Service ICO Trunk Connection apply when the total distance from the BellSouth Metro Ethernet Service ICO Trunk Connection wire center to the meet-point with the Independent Company is greater than 10 miles in length. The additional mileage is measured in airline miles from the BellSouth Metro Ethernet Service wire center associated with the BellSouth Metro Ethernet Service ICO Trunk Connection to the Independent Company meet-point. Fractions of miles will be considered as a whole mile.

Note 1: Automatic Protection Switching (APS) is not available for a 2 Mbps, 4 Mbps or 8 Mbps Basic, Premium or Virtual Connection.

Note 2: Effective on or after August 22, 2021, this Service will no longer be available for purchase by new or existing customers. In addition, requests to move, add, change, or renew existing service arrangements will not be accepted. Following the expiration of a customer's existing term agreement, service will be provided on a month-to-month basis at the applicable Monthly rates until the service is discontinued. The Company currently plans to discontinue this service on or after March 31, 2023.

(N)

(N)

E7. SPECIAL ACCESS (A.K.A. BELLSOUTH SPA) SERVICE

E7.2 Service Descriptions (Cont'd)

E7.2.18 BellSouth Metro Ethernet Service (Cont'd)¹

(C)

X. Migration to AT&T Switched Ethernet ServiceSM

Customers subscribing to BellSouth Metro Ethernet Service may migrate to AT&T Switched Ethernet Service provided by the Company without incurring termination charges, subject to the following conditions:

- The new AT&T Switched Ethernet Service and the existing BellSouth Metro Ethernet Service must be billed to the same customer of record at the same customer locations.
- The customer's existing service must have been in place for at least 12 months.
- The minimum term for the new service must be at least 12 months and must be equal to or greater than the number of months remaining in the customer's existing Transport Payment Plan (TPP) term.
- The speed (capacity/bandwidth) of the new service must be equal to or greater than that of the existing service.
- The customer must issue a disconnect order for the replaced BellSouth Metro Ethernet Service to be effective within 90 days after the AT&T Switched Ethernet Service installation date. The disconnect and new orders must be coordinated through the Company.
- If overlapping service is required, the period will be limited to not more than 90 days and billing will apply to both services during the time both services are available.

Note 1: Effective on or after August 22, 2021, this Service will no longer be available for purchase by new or existing customers. In addition, requests to move, add, change, or renew existing service arrangements will not be accepted. Following the expiration of a customer's existing term agreement, service will be provided on a month-to-month basis at the applicable Monthly rates until the service is discontinued. The Company currently plans to discontinue this service on or after March 31, 2023.

(N)

(N)

E7. SPECIAL ACCESS (A.K.A. BELLSOUTH SPA) SERVICE

E7.3 Facility Interface Codes

This section explains the facility interface codes set forth in E7.2.1 and E7.2.2 preceding that the IC can specify when ordering Special Access (a.k.a. BellSouth SPA) service. Included is an example which explains the specific characters of the code, a glossary of facility interface codes and impedance levels.

Example: If the IC specifies a 2DC8-3 facility interface at the IC terminal location, it is requesting the following:

- 2Number of Physical wires at IC terminal location
- DC.....Facility interface code for direct current or voltage
- 8Impedance
- 3Metallic¹ facilities (DC continuity) for DC/low frequency control signals or slow speed data (30 baud) (C)

E7.3.1 Glossary of Facility Interface Codes and Options

Code - Option	Definition	
AB	Accepts 20 Hz ringing signal at IC terminal location	
AC	Accepts 20 Hz ringing signal at the end user's premises	
CS -	Digital hierarchy interface at Digital Cross connect System (DCS)	
- EA	E&M Signaling	
- GO	Ground Start Loop Signaling - Open End	
- GS	Ground Start Loop Signaling - Closed End	
- LO	Loop Start Loop Signaling - Open End	
- LS	Loop Start Loop Signaling - Closed End	
- NO	Transmission Only - No Signaling	
- R	(DS0) Customer Reconfiguration Voice Grade Service ¹	(C)
- 10R	DS1 to DS0 Customer Reconfigurable ¹	
- 10	DS1 to DS0 ¹	(C)
- 11R	DS1 to DS1 Customer Reconfigurable	
- 11	DS1 to DS1	
- SP	Resistive Type: Split Path Operation for Data Polling Conference Type	
- CF	Resistive Type: Split Path Operation for Symmetrical Voice Conference Type	
- BC	CO Bridging: Broadcast for Broadcast Conference Type	
DA	Data stream in VF frequency band at end user network interface	
DB	Data stream in VF frequency band at IC point of interface location	

Note 1: Effective June 30, 2021, this Service will no longer be available for purchase by new or existing customers. In addition, requests to move, add, change, or renew existing service arrangements will not be accepted. Following the expiration of a customer's existing term agreement, service will be provided on a month-to-month basis at the applicable Monthly rates until the service is discontinued. The Company currently plans to discontinue this service on or after June 30, 2024.

(N)
|
(N)

E7. SPECIAL ACCESS (A.K.A. BELLSOUTH SPA) SERVICE

E7.3 Facility Interface Codes (Cont'd)

E7.3.1 Glossary of Facility Interface Codes and Options (Cont'd)

Code - Option	Definition
- 10	VF for NB4 and NB5
DC	Direct current or voltage
- 1	Monitoring interface with series RC combination (McCulloh format)
- 2	Company Energized alarm channel
- 3	Metallic ¹ facilities (DC continuity) for Direct Current/low frequency control signals or slow speed data (30 baud) (C)
(DELETED)	
(DELETED)	
D0	Digital interface at IC terminal location at the digital signal level zero A (DS-0A)
DS	Digital hierarchy interface
- 1K	1.544 Mbps (DS1) ANSI Extended Superframe (ESF) format per TA-TSY-000342
- 1S	1.544 Mbps (DS1) ANSI Extended Superframe (ESF) format and B8ZS Clear Channel Capability per TA-TSY-000342
- 15	1.544 Mbps (DS1) Superframe (SF) format per TA-TSY-000342
- 15B	1.544 Mbps (DS1) Superframe (SF) format and B8ZS Clear Channel Capability per TA-TSY-000342
- 15E	8-bit PCM encoded in one 64 Kbps of the DS1 signal
- 15F	8-bit PCM encoded in two 64 Kbps of the DS1 signal
- 15G	8-bit PCM encoded in three 64 Kbps of the DS1 signal
- 15H	14/11-bit PCM encoded in six 64 Kbps of the DS1 signal
- 15J	1.544 Mbps format per PUB 41451 (only available to U. S. Govt. agencies)
- 31	3.152 Mbps (DS1C)
- 31L	3.152 Mbps (DS1C) with SF signaling
- 44	44.736 Mbps (DS3)
- 44L	44.736 Mbps (DS3) with SF signaling
- 63	6.312 Mbps (DS2)
- 63L	6.312 Mbps (DS2) with SF signaling

Note 1: Effective June 30, 2021, this Service will no longer be available for purchase by new or existing customers. In addition, requests to move, add, change, or renew existing service arrangements will not be accepted. Following the expiration of a customer's existing term agreement, service will be provided on a month-to-month basis at the applicable Monthly rates until the service is discontinued. The Company currently plans to discontinue this service on or after June 30, 2024.

(N)
|
(N)

E7. SPECIAL ACCESS (A.K.A. BELLSOUTH SPA) SERVICE

E7.3 Facility Interface Codes (Cont'd)

E7.3.1 Glossary of Facility Interface Codes and Options (Cont'd)

Code - Option	Definition	
DU	Digital access interface	
- 19 (S) ¹	19.2 Kbps ²	(C)
- 24 (S) ¹	2.4 Kbps ²	
- 48 (S) ¹	4.8 Kbps ²	
- 56 (S) ¹	56.0 Kbps ²	
- 64	64.0 Kbps ²	
- 96 (S) ¹	9.6 Kbps ²	(C)
- 1KN	DS1 (1.544 Mbps) ANSI Extended Superframe (ESF) Format per TR-NPL-000054 without line power	
- 1SN	DS1 (1.544 Mbps) ANSI Extended Superframe (ESF) Format per TR-NPL-000054, with B8ZS Clear Channel Capability and without line power	
- A	DS1 1.544 Mbps free-framing format per PUB 41451 with line power (only available to U. S. Govt. agencies)	
- AN	DS1 (1.544 Mbps) free-framing format per PUB 41451 without line power (only available to U. S. Govt. agencies)	
- BN	DS1 (1.544 Mbps) Superframe (SF) Format per TR-NPL-000054 without line power	
- DN	DS1 (1.544 Mbps) Superframe (SF) Format per TR-NPL-000054, with B8ZS Clear Channel Capability and without line power	
- SN	1.544 Mbps (DS1) ANSI Extended Superframe (ESF) format and B8ZS Clear Channel Capability	
DV	Data and Voice Multiplexing	
- BA	Derived Data Channel, 2.4 Kbps ²	(C)
- BC	Data Over Voice, 9.6 Kbps ²	(C)
Note 1:	(S) is an additional BellSouth designation for use when the optional Secondary Channel feature is required.	
Note 2:	Effective June 30, 2021, this Service will no longer be available for purchase by new or existing customers. In addition, requests to move, add, change, or renew existing service arrangements will not be accepted. Following the expiration of a customer's existing term agreement, service will be provided on a month-to-month basis at the applicable Monthly rates until the service is discontinued. The Company currently plans to discontinue this service on or after June 30, 2024.	(N) (N)

E7. SPECIAL ACCESS (A.K.A. BELLSOUTH SPA) SERVICE

(T)

E7.3 Facility Interface Codes (Cont'd)

E7.3.1 Glossary of Facility Interface Codes and Options (Cont'd)

Code - Option	Definition	
DX	Duplex signaling interface at IC point of interface	(M)
DY	Duplex signaling interface at end user network interface	(M)
EA	Type I, E&M lead signaling.	(M)
- E	IC at point of interface or end user at network interface.	(M)
- M	IC at point of interface or end user at network interface originating on M Lead.	(M)
EB	Type II, E&M lead signaling.	
- E	IC at point of interface or end user at network interface originating on M Lead.	(M)
EC	Type III, E&M signaling at IC terminal point of interface.	
EX	Tandem channel unit signaling for loop start or ground start	
- A	IC supplies open end (dial pulsing, etc.) functions.	(M)
- B	IC supplies closed end (dial pulsing, etc.) functions.	(M)
GO	Ground start loop signaling - open end functions by IC or end user	(M)
GS	Ground start loop signaling - closed end functions by IC or end user	(M)
IA	E.I.A. (25 pin RS-232)	(M)
LA	End user loop start loop signaling - Type A OPS registered port open end	(M)
LB	End user loop start loop signaling - Type B OPS registered port open end	(M)
LC	End user loop start loop signaling - Type C OPS registered port open end	(M)
LO	Loop start loop signaling - open end functions by IC or end user	
LR	20 Hz automatic ringdown interface at IC with Company provided PLAR	
LS	Loop start loop signaling - closed end functions by IC or end user	(M)
NO	No signaling interface, transmission only	(M)
PG	Program transmission - no dc signaling	(M)
- 1	Nominal frequency from 50 to 15,000 Hz	(M)
- 3	Nominal frequency from 200 to 3,500 Hz	(M)
- 5	Nominal frequency from 100 to 5,000 Hz	(M)

E7. SPECIAL ACCESS (A.K.A. BELLSOUTH SPA) SERVICE

E7.3 Facility Interface Codes (Cont'd)

E7.3.1 Glossary of Facility Interface Codes and Options (Cont'd)

Code - Option	Definition	
- 8	Nominal frequency from 50 to 8,000 Hz	
RV	Reverse battery signaling	
- 0	One way operation, originate at IC	
- T	Reverse battery signaling, one way operation, terminate function by IC or end user	
SF	Single frequency signaling within VF band at either IC point of interface or end user network interface	
TF	Telephotograph ¹ interface	(C)
TT	Telegraph ¹ /teletypewriter interface at either IC point of interface or end user network interface	(C)
- 2	20.0 milliamperes	
- 3	3.0 milliamperes	
- 6	62.5 milliamperes	
TV	Television interface	
- 3	Commercial Quality Video (<i>a.k.a. BellSouth SPA Commercial Quality Video</i>) and two 15 kHz audio signals	

E7.3.2 Impedance

The nominal reference impedance with which the IC or end user will terminate the channel for the purposes of evaluating transmission performance.

Value (ohms)	Code(s)
110	0
150	1
600	2
900	3
1200	4
135	5
75	6
124	7
Variable	8
100	9

E7.3.3 Digital Hierarchy Facility Interface Codes (4DS9-*)

This facility interface is available only to ICs that select the channelized four-wire DSX-1 or higher facility interface option at the IC terminallocation and provide subsequent system and channel assignment data.

The various digital bit rates in the digital hierarchy employ the facility interface code 4DS9 plus the speed options indicated following:

Interface Code and Speed Option	Normal Bit Rate (Mbps)	Digital Hierarchy Level
4DS9-15	1.54	DS1
4DS9-31	3.15	DS1C
4DS0-63	6.31	DS2
4DS6-44	44.74	DS3

Note 1: Effective June 30, 2021, this Service will no longer be available for purchase by new or existing customers. In addition, requests to move, add, change, or renew existing service arrangements will not be accepted. Following the expiration of a customer's existing term agreement, service will be provided on a month-to-month basis at the applicable Monthly rates until the service is discontinued. The Company currently plans to discontinue this service on or after June 30, 2024.

(N)
|
(N)

E7. SPECIAL ACCESS (A.K.A. BELL SOUTH SPA) SERVICE

E7.4 Rate Regulations

This section contains the specific regulations governing the rates and charges that apply for Special Access (a.k.a. BellSouth SPA) service.

E7.4.1 Types of Rates and Charges

- A. There are two types of rates and charges. These are monthly rates and nonrecurring charges. In addition, there are three types of nonrecurring charges. The rates and charges are described as follows:

1. Monthly Rates

Monthly rates are flat recurring charges that apply each month or fraction thereof that a Special Access (a.k.a. BellSouth SPA) service is provided. For billing purposes, each month is considered to have thirty days.

Digital Data Access⁽³⁾ (a.k.a. BellSouth SPA DS0 Digital Data) service is offered under two contract plans. Contract plan rates are available in payment periods from 24 to 42 months and in payment periods 43 to 72 months under conditions specified in the Channel Services Payment Plan (CSPP) in E2.4 of this Tariff.

A termination charge is applicable at the date of termination if the IC terminates or disconnects the service prior to fulfilling the period of the contract plan except as specified in b. and c. following. The termination charge is determined by multiplying the contracted monthly rates times the number of months the service has been installed, multiplied by a factor. The factor is fifty percent (50%) for contracts that have been in effect twelve months (12) or less, or twenty percent (20%) for contracts that have been in effect longer than twelve months (12). An example is provided in a. following.

The following list identifies the individual Special Access (a.k.a. BellSouth SPA) services provided under Section E7. of this Tariff which are eligible for credit of nonrecurring charges under "Service Installation Guarantee" found in E2.4.10 of this Tariff. Customers with these services are not eligible for the Service Installation Guarantee when the requested installation, move or rearrangement service order interval is four days or less as measured from the Application Date of the order.

- Voice Grade⁽³⁾ (a.k.a. BellSouth SPA DS0 VG)

- **(DELETED)**

- Digital Data Access (a.k.a. BellSouth SPA DS0 Digital Data) service⁽¹⁾⁽³⁾

- High Capacity^{6, 7} (a.k.a. BellSouth SPA High Capacity) service

- SMARTRing⁽⁵⁾ service (a.k.a. BellSouth Dedicated Ring)

Provided, however, that the following services are not eligible for such credit.

- BellSouth SPA CNM - FlexServ service

- BellSouth Metro Ethernet⁽⁴⁾ service

- a. An IC subscribes to Digital Data Access⁽³⁾ (a.k.a. BellSouth SPA DS0 Digital Data) service using the 24 to 42 month payment plan. The contract plan period is for 30 months. The subscriber terminates the service after 12 months. The total liability is 30 months times the monthly rate. The amount is then reduced to reflect the number of months the subscriber has had the service, which in this example is 12 months. Therefore, the termination charge is fifty percent (50%) of this amount calculated as follows:

$$\text{Termination Charge} = .50 \times [(30 \text{ months} \times \text{monthly rate}) - (12 \text{ months} \times \text{monthly rate})]$$

Note 1: The Data Over Voice Channel optional feature is not eligible for such credit.

Note 2: **(DELETED)**

Note 3: Effective June 30, 2021, this Service will no longer be available for purchase by new or existing customers. In addition, requests to move, add, change, or renew existing service arrangements will not be accepted. Following the expiration of a customer's existing term agreement, service will be provided on a month-to-month basis at the applicable Monthly rates until the service is discontinued. The Company currently plans to discontinue this service on or after June 30, 2024.

Note 4: Effective on or after August 22, 2021, this Service will no longer be available for purchase by new or existing customers. In addition, requests to move, add, change, or renew existing service arrangements will not be accepted. Following the expiration of a customer's existing term agreement, service will be provided on a month-to-month basis at the applicable Monthly rates until the service is discontinued. The Company currently plans to discontinue this service on or after March 31, 2023.

Note 5: Effective on or after December 1, 2021, neither new nor existing customers will be permitted to purchase new SMARTRing Service (Service). In addition, (A) Service Payment Plans greater than 12-months in length will no longer be available; and (B) requests to move, add, change, upgrade, or downgrade existing service arrangements will not be accepted, with the following exceptions: (1) existing customers will be permitted to modify their existing Service and will be able to add new circuits to their existing Service, but will not be permitted to add new nodes in any locations; and (2) any such new circuits will be subject to the customer's existing term payment plan or term agreement for the Service to which they are added. Following the expiration of a customer's existing term agreement, Service will be provided on a month-to-month basis at the applicable Month-to-Month rates until the Service is discontinued.

Effective November 30, 2023, unless specified to the contrary in their existing Service agreements, existing customers may not renew Term Payment Plans or term agreements for Service. In addition, no move, add, or change orders of any type will be accepted.

Note 6: Effective November 1, 2022, customers may not establish new term plans of greater than 24 months for High Capacity Service Channel Service Payment Plans.

Note 7: Effective March 17, 2024, customers may not establish new term plans of greater than month-to-month for High Capacity Service Channel Service Payment Plans.

(C)

(N)

E7. SPECIAL ACCESS (A.K.A. BELLSOUTH SPA) SERVICE

E7.4 Rate Regulations (Cont'd)

E7.4.1 Types of Rates and Charges (Cont'd)

A. (Cont'd)

1. (Cont'd)

- b. A termination charge will not be applicable at the date of termination if the IC terminates or disconnects the service prior to fulfilling the period of the contract plan for IC requested changes to a higher order of service covered by the CSPP as specified in E2.4.9.A.4.b. of this Tariff or IC requested changes to services not covered by the CSPP that are offered by the Company under a contract payment plan provided that the applicable conditions set forth in E2.4.9.A.4.b. of this Tariff are satisfied. (M)
- c. Termination charges will not apply for IC requests for moves of service under CSPP subject to the provisions set forth in E2.4.9.A.10. preceding. (M)

2. **(DELETED)**

3. Nonrecurring Charges

First and Additional nonrecurring charges are applicable to activate each individual Central Office Channel Interface of a DS1 or DS0 Basic Channelization System¹, and are in addition to the nonrecurring charges for the DS1 or DS0 Basic Channelization System¹. A "First" Central Office Channel Interface nonrecurring charge is applicable to the first Central Office Channel Interface installed coincident with the installation of a DS1 or DS0 Basic Channelization System¹, per service request. An "Additional" nonrecurring charge applies for each additional Central Office Channel Interface, of the same type, ordered and installed at the same location, for the same customer, at the same time, on the same order request. Future requests for a Central Office Channel Interface(s) on an existing DS1 or DS0 Basic Channelization System¹ will be treated as new requests and will require "First" and "Additional" Central Office Channel Interface nonrecurring charge application, in addition to any other applicable charges.

One nonrecurring charge is applicable for each individual DS1 level Central Office or Customer Channel Interface and is in addition to any other applicable charges.

Nonrecurring charges are one-time charges that apply for a specific work activity (i.e., installation or change to an existing service). The three types of nonrecurring charges that apply for Special Access (a.k.a. BellSouth SPA) service are:

- Installation of service,
- Installation of feature(s) and/or function(s), and
- Service rearrangements

a. Installation of Service

Nonrecurring charges apply to each service installed. When multiple identical services (i.e., services between the same locations and for the same customer) are ordered and installed at the same time, there is a charge for the first service installed and a lower charge for each additional identical service installed. Nonrecurring charges for the installation of all Services but Dedicated Access Line Service apply per service termination (i.e., IC terminal location and end user's premises).

(DELETED)

b. Installation of Features and Functions

Nonrecurring charges apply for the installation of the various features and functions available with Special Access (a.k.a. BellSouth SPA) service. For some features and functions there is a lower charge if installed coincident with the service and a higher charge if installed subsequent to the service.

c. Service Rearrangements

- (1) Service rearrangements are changes to existing (installed) services which do not result in either a change in the minimum period requirements as set forth in E5.2.5.E. preceding or a change in the physical location of the point of the termination at a customer designated premises. Changes which result in the establishment of new minimum period obligations are treated as disconnects and starts. Changes in the physical location of the point of the termination are treated as moves and are described and charged for as set forth in 2.c.(4) following. A change which results from a transfer of service is described and charged as set forth in d. and E7.5.13 following.

If there is a relocation of the demarcation point, it will be subject to FCC Rules and Regulations as specified in Part 68.

- (2) The charge to the IC for the service rearrangement is dependent on whether the change is administrative only in nature or involves actual physical change to the service.

Note 1: Effective June 30, 2021, this Service will no longer be available for purchase by new or existing customers. In addition, requests to move, add, change, or renew existing service arrangements will not be accepted. Following the expiration of a customer's existing term agreement, service will be provided on a month-to-month basis at the applicable Monthly rates until the service is discontinued. The Company currently plans to discontinue this service on or after June 30, 2024.

E7. SPECIAL ACCESS (A.K.A. BELLSOUTH SPA) SERVICE

E7.4 Rate Regulations (Cont'd)

E7.4.1 Types of Rates and Charges (Cont'd)

A. (Cont'd)

3. Nonrecurring Charges (Cont'd)

c. Service Rearrangements (Cont'd)

(3) Administrative changes, identified as follows, will be made without charge(s) to the IC. Such changes require the continued provision and billing of the Access Service to the same entity (i.e., IC remains responsible for all outstanding indebtedness for the Access Service). Administrative changes are as follows:

- Change of customer name (i.e., the customer of record does not change but rather the customer of record changes its name -- e.g., AT&T-Long Lines to AT&T-Communications),
- Change of end user premises address when the change of address is a result of a physical relocation of equipment,
- Change in billing data (name, address, or contact name or telephone number. The customer of record does not change.)
- Change of circuit identification,
- Change of billing account number,
- Change of test line number,
- Change of end user contact name or telephone number, and

Change of jurisdiction, e.g., intraLATA to intrastate, intrastate to interstate, etc. No Termination Liability Charges apply for services billed under the Channel Services Payment Plan (CSPP) if the customer subscribes to a payment arrangement offered in the appropriate tariff which is a minimum twenty-four month service period or equals/exceeds the remaining contract period, whichever is greater.

(4) All other service rearrangements including physical changes to existing services, will be charged for as follows:

- If the change involves the addition of other designated premises to an existing multipoint service, the nonrecurring charge for the Local Channel rate element will apply. The charge(s) will apply only for the location(s) that is being added.
- If the change involves the addition of an optional feature or function which has a separate nonrecurring charge, that nonrecurring charge will apply.
- If the change involves changing the type of signaling on a Voice Grade¹ (a.k.a. BellSouth SPA DS0 VG) service, a charge equal to the Voice Grade¹ (a.k.a. BellSouth SPA DS0 VG) Local Channel rate element nonrecurring charge will apply. The charge will apply per service termination affected.
- If the change involves changing (reconfiguring) an existing BellSouth Metro Ethernet² service Connection, appropriate charges provided in E7.4.32 following apply.
- If the change involves the addition of a DS3 Network Interface Unit (NIU) to a SMARTRing³ service (a.k.a. BellSouth SPA Dedicated Ring) the rates and charges shown in E13.3.25.
- For all other changes, including a change of the customer of record involving no physical changes to the service provided or the addition of optional features without separate nonrecurring charges, a charge equal to a Local Channel rate element nonrecurring charge will apply. Only one such charge will apply per service, per change.

d. Transfer of Service

When a change in billing data (e.g., name, address, contact name, or telephone number) is requested in association with a change in the customer of record, transfer of service charges, as set forth in E7.5.13 following will apply. Charges are applied on a Billing Account Number (BAN) and per circuit basis.

Note 1: Effective June 30, 2021, this Service will no longer be available for purchase by new or existing customers. In addition, requests to move, add, change, or renew existing service arrangements will not be accepted. Following the expiration of a customer's existing term agreement, service will be provided on a month-to-month basis at the applicable Monthly rates until the service is discontinued. The Company currently plans to discontinue this service on or after June 30, 2024.

Note 2: Effective on or after August 22, 2021, this Service will no longer be available for purchase by new or existing customers. In addition, requests to move, add, change, or renew existing service arrangements will not be accepted. Following the expiration of a customer's existing term agreement, service will be provided on a month-to-month basis at the applicable Monthly rates until the service is discontinued. The Company currently plans to discontinue this service on or after March 31, 2023.

Note 3: Effective on or after December 1, 2021, neither new nor existing customers will be permitted to purchase new SMARTRing Service (Service). In addition, (A) Service Payment Plans greater than 12-months in length will no longer be available; and (B) requests to move, add, change, upgrade, or downgrade existing service arrangements will not be accepted, with the following exceptions: (1) existing customers will be permitted to modify their existing Service and will be able to add new circuits to their existing Service, but will not be permitted to add new nodes in any locations; and (2) any such new circuits will be subject to the customer's existing term payment plan or term agreement for the Service to which they are added. Following the expiration of a customer's existing term agreement, Service will be provided on a month-to-month basis at the applicable Month-to-Month rates until the Service is discontinued.

Effective November 30, 2023, unless specified to the contrary in their existing Service agreements, existing customers may not renew Term Payment Plans or term agreements for Service. In addition, no move, add, or change orders of any type will be accepted.

E7. SPECIAL ACCESS (A.K.A. BELLSOUTH SPA) SERVICE

E7.4 Rate Regulations (Cont'd)

E7.4.2 Surcharge for Special Access (a.k.a. BellSouth SPA) Service

A. General

In addition to the rates and charges described in E7.4.1 preceding, there is a monthly surcharge of \$25.00 that applies to the termination of Sub-Voice, Voice Grade² (a.k.a. BellSouth SPA DS0 VG) and equivalent voice grade² Special Access (a.k.a. BellSouth SPA) services (e.g., the surcharge for a group level service would be \$300.00 or 12 x \$25.00). For Narrowband, Voice Grade² (a.k.a. BellSouth SPA DS0 VG) and Digital Data Access² (a.k.a. BellSouth SPA DS0 Digital Data) multipoint services, the surcharge applies for each end user location on the service. This surcharge is to compensate the Company for use of the local exchange network by Special Access (a.k.a. BellSouth SPA) services that are classified as intrastate jurisdiction.

B. Exceptions to the Surcharge Application

Recognizing that not all services can utilize the local exchange network, certain uses of Special Access (a.k.a. BellSouth SPA) service are exempt from the surcharge. Following is a listing of the exempt categories:

1. Any termination of an analog service that is used for television transmission. (D)
2. Any termination of a service that is used for Telex service.
3. Any termination of a service that by nature of its operating characteristics could not make use of common lines. The determination of such usage is made based upon the arrangement at the subscriber's end of the channel.
4. Any termination of a WATS² (a.k.a. BellSouth SPA WATS Line) or BellSouth SWA 8XX Toll Free Dialing Ten Digit Screening Service access line.

C. Self Reporting

In order for the Company to determine the application of the surcharge with respect to specific services, the IC must report the intended use of all services when placing orders for Special Access (a.k.a. BellSouth SPA) service. In addition, when ordering high capacity analog or digital services, the IC must also report the use for each voice equivalent channel of the high capacity service. When any service or channel of a service is reported to be the used in any manner described in B. preceding, the surcharge will not apply. If the intended use is not reported, the Company will automatically bill the appropriate surcharge on each Special Access (a.k.a. BellSouth SPA) service installed.

The Company reserves the right to audit the use of the service at any time. If the service is found to be used for a type of operation other than that reported by the IC, and a surcharge would apply for that type of operation, the Company will notify the IC and will begin to apply the surcharge.

D. A Message Station Equipment Recovery Charge is a charge to recover that portion of message station equipment that is assigned to Special Access (a.k.a. BellSouth SPA) service.

This charge is assessed only to those customers to which the Special Access (a.k.a. BellSouth SPA) Surcharge applies. The rate for the Message Station Equipment Recovery Charge is set forth in E7.5.11.

E7.4.3 Minimum Periods

Special Access (a.k.a. BellSouth SPA) service is provided for a specified minimum period *as stated in E5.2.5*.

Minimum periods and minimum period charges are described in detail in *Section E5*. preceding.

E7.4.4 Moves

A. A move involves a change in the physical location of one of the following:

1. The point of interface at the IC terminal location
2. The IC terminal location
3. The network interface at the end user premises
4. The end user premises
5. The WATS² (a.k.a. BellSouth SPA WATS Line) serving office (WATS Access Line² (a.k.a. BellSouth SPA WATS Line) service only)

Note 1: *(DELETED)*

Note 2: Effective June 30, 2021, this Service will no longer be available for purchase by new or existing customers. In addition, requests to move, add, change, or renew existing service arrangements will not be accepted. Following the expiration of a customer's existing term agreement, service will be provided on a month-to-month basis at the applicable Monthly rates until the service is discontinued. The Company currently plans to discontinue this service on or after June 30, 2024. (T)

E7. SPECIAL ACCESS (A.K.A BELLSOUTH SPA) SERVICE

E7.4 Rate Regulations (Cont'd)

E7.4.4 Moves (Cont'd)

- B. The charges for the move are dependent on whether the move is to a new location within the same building or to a different building.
1. Moves Within the Same Building

When the move is to a new location within the same building for all services except WATS Access Line¹ (a.k.a. BellSouth SPA WATS Line) service, the charge for the move will be an amount equal to one-half the nonrecurring (i.e., installation) charge for the service termination affected (i.e., the IC terminal location or the end user premises). For WATS Access Line¹ (a.k.a. BellSouth SPA WATS Line) services, the charge for the move will be the amount equal to one-half of the nonrecurring charge of the Local Channel used to provide the service. There will be no change in the minimum period requirements. If a move is made at the same time a service rearrangement is made, the total charge will never exceed a full non-recurring charge for the basic service.
 2. To a Different Building

Moves to a different building, other than addressed in 3. following, will be treated as a discontinuance and start of service and all associated nonrecurring charges will apply. New minimum period requirements will be established at the new location. The IC will also remain responsible for satisfying all outstanding minimum period charges for the discontinued service.
 3. Moves of Service(s) under CSPP

IC requests for moves of service under CSPP, other than inside moves, will be subject to the conditions of E2.4.9.A.10. preceding.

E7.4.5 Rate Application Exception Rules

- A. WATS Access Line¹ (a.k.a. BellSouth SPA WATS Line) Service
- When interLATA only WATS Access Line (a.k.a. BellSouth SPA WATS Line) service is provided, the only rate elements which apply are Local Channels (LC) between the end user premises and the end office (i.e., WATS or WATS like serving office) and, when the end office is not a WATS or WATS like serving office, Interoffice Channel (IOC) to extend the LC to a WATS or WATS like serving office. The nonrecurring charge for this service is that for the LC Interoffice Channel charges are not applicable to interexchange carriers providing combined (add-on) WATS/800 or WATS/800-like service.
- When extensions of interLATA only WATS Access Line (a.k.a. BellSouth SPA WATS Line) service (i.e., additional terminations of the service at another building in the same or a different LATA) are provided, they are rated in the following manner. Extensions within the LATA are provided as additional LC and IOC as required. The LC nonrecurring charge will also apply. Extensions in different LATAs of interLATA only and combined (add-on) WATS/800 and WATS/800-like service are rated as LOC (from the extension bridging point to the IC serving wire center). No Special Access (a.k.a. BellSouth SPA) service Surcharge applies to the extension service.
- WATS Access Line (a.k.a. BellSouth SPA WATS Line) service, including extensions, will not be charged to interexchange carriers when the end user is charged for the equivalent services via BellSouth intraLATA WATS/800. Rates for BellSouth intraLATA WATS/800 service can be *found in North Carolina's Non-Regulated Services – Pricing publication.*

Note 1: Effective June 30, 2021, this Service will no longer be available for purchase by new or existing customers. In addition, requests to move, add, change, or renew existing service arrangements will not be accepted. Following the expiration of a customer's existing term agreement, service will be provided on a month-to-month basis at the applicable Monthly rates until the service is discontinued. The Company currently plans to discontinue this service on or after June 30, 2024.

(N)
|
(N)

E7. SPECIAL ACCESS (A.K.A. BELL SOUTH SPA) SERVICE

E7.4 Rate Regulations (Cont'd)

E7.4.6 Mileage Measurement

- A. The mileage to be used to determine the monthly rate for the Interoffice Channel is calculated on the airline distance between the serving wire centers involved (i.e., IC serving wire center, Hub serving wire center or end user serving wire center). The V and H coordinates method is used to determine mileage. This method is explained in Section E10. The serving wire center V and H coordinates are set forth in the Exchange Carrier Association Tariff F.C.C. No. 4.
- B. A flat rate and a rate per mile applies for interoffice mileage.
- C. When Hubs are involved, mileage rates are computed separately for each section of the Interoffice Channel Mileage, i.e., IC serving wire center to Hub, Hubs to Hub and/or Hubs to end user serving wire center. E7.4.7 Facility Hubs
- D. SMARTRing[®] service (a.k.a. BellSouth Dedicated Ring) Local Channel, Alternate Central Office Channel and Internodal Channel rates are also distance sensitive. They are measured per quarter airline mile or fraction thereof from the customer's designated premises to the Serving Wire Center, Alternate Central Office, or other Customer Nodes. V&H coordinates are derived for each customer location through the use of longitude and latitude measurements. Using the V&H coordinate method as set forth in the NATIONAL EXCHANGE CARRIER ASSOCIATION, INC. TARIFF FCC. No. 4, compute the mileage, convert to quarter miles, and multiply the appropriate per quarter mile rate by the distance involved. Any portion of a quarter mile will always round up to the next quarter mile before determining the mileage and applying the rate. (C)
- E. The SMARTRing[®] service (a.k.a. BellSouth Dedicated Ring) Interoffice Channel mileage is calculated per quarter airline mile between two directly connected central offices on the ring. Interoffice Channel mileage is computed by using the V&H coordinates method as set forth in the NATIONAL EXCHANGE CARRIER ASSOCIATION, INC. TARIFF FCC. No. 4. To determine the rate to be billed, multiply the appropriate per quarter mile rate by the distance involved. Fractions of a quarter mile always round up to the next quarter mile before determining the mileage and applying the rate. (C)

(M)

(N)

Note 1: Effective on or after December 1, 2021, neither new nor existing customers will be permitted to purchase new SMARTRing Service (Service). In addition, (A) Service Payment Plans greater than 12-months in length will no longer be available; and (B) requests to move, add, change, upgrade, or downgrade existing service arrangements will not be accepted, with the following exceptions: (1) existing customers will be permitted to modify their existing Service and will be able to add new circuits to their existing Service, but will not be permitted to add new nodes in any locations; and (2) any such new circuits will be subject to the customer's existing term payment plan or term agreement for the Service to which they are added. Following the expiration of a customer's existing term agreement, Service will be provided on a month-to-month basis at the applicable Month-to-Month rates until the Service is discontinued.

Effective November 30, 2023, unless specified to the contrary in their existing Service agreements, existing customers may not renew Term Payment Plans or term agreements for Service. In addition, no move, add, or change orders of any type will be accepted. (N)

E7. SPECIAL ACCESS (A.K.A. BELL SOUTH SPA) SERVICE

E7.4 Rate Regulations (Cont'd)

E7.4.7 Facility Hubs

1. An IC has the option of ordering high capacity analog or digital facilities (i.e., DS1, DS1C, DS2 or DS3) to a facility Hub for channelizing to individual services requiring lower capacity facilities (e.g., Voice² (a.k.a. BellSouth SPA DS0 VG), etc.).

(D)

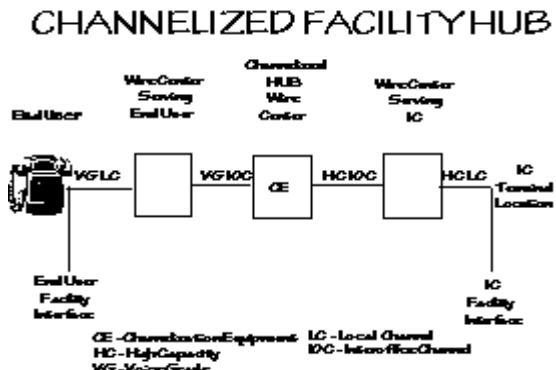

2. The Company will designate the facility Hub locations. Different locations may be designated as Hubs for different facility capacities, e.g., channelization from digital to digital may occur at one location while channelization from digital to analog may occur at a different location. The IC will choose the desired Hub from a list that the Company will make available.
3. Some of the types of channelization provided include the following:
 - From higher to lower bit rate
 - From higher to lower bandwidth
 - From digital to Voice Grade² (a.k.a. BellSouth SPA DS0 VG) service
4. The transmission performance for the end to end service provided from the IC terminal location to the end user premises will be that of the lower capacity or bit rate. For example, when a 1.544 Mbps service is channelized to voice frequency channels, the transmission performance will be voice grade², not high capacity.
5. The Company will commence billing the monthly rate for the Local Channel and the Interoffice Channel for the high capacity facility to the Hub as soon as it is provided, even though individual services utilizing those facilities may not be ordered and installed until a later date. If the IC has designated the type of channelization to be provided, the nonrecurring charge for the Basic Channelization System will be billed to the IC at that time and the billing for the monthly rate will begin. DS1 and DS0 Basic Channelization Systems² require a Central Office Channel Interface for activation of each lesser capacity channel. DS3 to DS1 channelization arrangements, for transport of intrastate DS1 service high capacity channels via services such as LightGate service (a.k.a. BellSouth SPA Point to Point Network) and SMARTRing³ service (a.k.a. BellSouth SPA Dedicated Ring), require a DS1 channel interface for activation of each DS1 channel.
6. Individual service rates (by service type) will apply for the Local Channel, and additional Interoffice Channel and Central Office Channel Interface(s) (as required) for each channelized service. These will be billed to the IC as each individual service is installed.

(D)

Note 1: (DELETED)

(T)

Note 2: Effective June 30, 2021, this Service will no longer be available for purchase by new or existing customers. In addition, requests to move, add, change, or renew existing service arrangements will not be accepted. Following the expiration of a customer's existing term agreement, service will be provided on a month-to-month basis at the applicable Monthly rates until the service is discontinued. The Company currently plans to discontinue this service on or after June 30, 2024.

Note 3: Effective on or after December 1, 2021, neither new nor existing customers will be permitted to purchase new SMARTRing Service (Service). In addition, (A) Service Payment Plans greater than 12-months in length will no longer be available; and (B) requests to move, add, change, upgrade, or downgrade existing service arrangements will not be accepted, with the following exceptions: (1) existing customers will be permitted to modify their existing Service and will be able to add new circuits to their existing Service, but will not be permitted to add new nodes in any locations; and (2) any such new circuits will be subject to the customer's existing term payment plan or term agreement for the Service to which they are added. Following the expiration of a customer's existing term agreement, Service will be provided on a month-to-month basis at the applicable Month-to-Month rates until the Service is discontinued.

Effective November 30, 2023, unless specified to the contrary in their existing Service agreements, existing customers may not renew Term Payment Plans or term agreements for Service. In addition, no move, add, or change orders of any type will be accepted.

E7. SPECIAL ACCESS (A.K.A. BELLSOUTH SPA) SERVICE

E7.4 Rate Regulations (Cont'd)

(M)

E7.4.8 Shared Use Analog and Digital High Capacity Services

Shared use occurs when Special Access (a.k.a. BellSouth SPA) service and BellSouth SWA are provided over the same High Capacity facility through a common interface. When the IC orders Special Access (a.k.a. BellSouth SPA) service, the facility will be rated as Special Access (a.k.a. BellSouth SPA) service (i.e., Local Channel, or Virtual Collocation Cross-Connect, Interoffice Channel, as appropriate, and Basic Channelization System and Central Office Interface(s), if applicable) until such time as the IC chooses to use a portion of the available capacity for providing BellSouth SWA. As each individual channel is activated for BellSouth SWA, the Special Access (a.k.a. BellSouth SPA) Local Channel rates, Interoffice Channel rates, and Basic Channelization System rates, if applicable, will be reduced accordingly (e.g., 1/24th for a DS1 service, etc.). The customer must place an order for each individual BellSouth SWA or Special Access (a.k.a. BellSouth SPA) service utilizing the Shared Use Facilities and specify the channel assignment for each such service. BellSouth SWA rates and charges as set forth in E6.8 preceding will apply for each channel of the shared use facility that is used to provide BellSouth SWA. Where Special Access (a.k.a. BellSouth SPA) service is provided utilizing a channel(s) of the shared use facility to the Hub, High Capacity rates and charges will apply for the facility to the Hub as set forth preceding and individual service rates and charges will apply from the Hub to the customer designated premises. The rates and charges that will apply to the portion from the Hub to the customer designated premises will be dependent on the specific type of Special Access (a.k.a. BellSouth SPA) service that is provided (e.g., Voice Grade¹ (a.k.a. BellSouth SPA DS0 VG), Digital Data Access¹ (a.k.a. BellSouth SPA DS0 Digital Data) service, etc.). The applicable rates and charges will include a Local Channel and Interoffice Channel, if applicable. See also E5.2.7 preceding.

Access Collocation Cross-Connects provide a means for customers to interconnect their BellSouth Shared Use and Digital High Capacity (a.k.a. BellSouth SPA High Capacity) services to Central Office Collocation arrangements within the same Central Office. Terms, conditions, and rates for Physical Access Collocation Cross-Connects and Virtual Access Collocation Cross-Connects are set forth in Section E13. of this Tariff.

The capability exists for a customer to utilize all or part of a SMARTRing² service (a.k.a. BellSouth Dedicated Ring) to transport switched access provided the SMARTRing² service (a.k.a. BellSouth Dedicated Ring) channel interface transporting the BellSouth SWA service does not have FlexServ service (a.k.a. BellSouth SPA Customer Reconfiguration) capability. The customer must place an order for each individual BellSouth SWA Channel provided over Dedicated Access service Shared Use Facilities and specify the channel assignment for each such service. The switched traffic would enter and exit the SMARTRing² service (a.k.a. BellSouth Dedicated Ring) at Customer and Central Office Nodes on that network. When this occurs, ratcheting of Dedicated Access rate elements (i.e. Nodes, Channel Interfaces, Local Channels, Alternate Central Office Channels, Internodal Channels, or Interoffice Channels) will be based on the number of voice grade¹ (a.k.a. BellSouth SPA DS0 VG) equivalent trunks/lines of that rate element used for BellSouth SWA access.

(C)

Reduction factors will be developed to reduce the charges on system level billing as well as the billing on individual DS1, DS3, STS-1, OC-3, and/or OC-12 Channel Interfaces. For ratcheting purposes, the system level charges include Customer Nodes, Central Office Nodes, Local Channels, Alternate Central Office Channels, Internodal Channels, and Interoffice Channels as appropriate to make up a customer's SMARTRing² service (a.k.a. BellSouth Dedicated Ring). Individual OC-1, OC-3 and OC-12 Channel Interfaces used in Overlay Ring Arrangements will be ratcheted as system level charges. The system reduction factor will apply to the system level charges.

(C)

Note 1: Effective June 30, 2021, this Service will no longer be available for purchase by new or existing customers. In addition, requests to move, add, change, or renew existing service arrangements will not be accepted. Following the expiration of a customer's existing term agreement, service will be provided on a month-to-month basis at the applicable Monthly rates until the service is discontinued. The Company currently plans to discontinue this service on or after June 30, 2024.

Note 2: Effective on or after December 1, 2021, neither new nor existing customers will be permitted to purchase new SMARTRing Service (Service). In addition, (A) Service Payment Plans greater than 12-months in length will no longer be available; and (B) requests to move, add, change, upgrade, or downgrade existing service arrangements will not be accepted, with the following exceptions: (1) existing customers will be permitted to modify their existing Service and will be able to add new circuits to their existing Service, but will not be permitted to add new nodes in any locations; and (2) any such new circuits will be subject to the customer's existing term payment plan or term agreement for the Service to which they are added. Following the expiration of a customer's existing term agreement, Service will be provided on a month-to-month basis at the applicable Month-to-Month rates until the Service is discontinued.

(N)

Effective November 30, 2023, unless specified to the contrary in their existing Service agreements, existing customers may not renew Term Payment Plans or term agreements for Service. In addition, no move, add, or change orders of any type will be accepted.

(N)

E7. SPECIAL ACCESS (A.K.A. BELLSOUTH SPA) SERVICE

E7.4 Rate Regulations (Cont'd)

E7.4.8 Shared Use Analog and Digital High Capacity Services (Cont'd)

The system reduction factor will be derived by dividing the number of activated BellSouth SWA access circuits by the voice grade¹ (a.k.a. BellSouth SPA DS0 VG) channel equivalent capacity of the self-healing ring. An OC-1 SMARTRing^{®2} service (a.k.a. BellSouth Dedicated Ring) has 672 voice grade¹ (a.k.a. BellSouth SPA DS0 VG) equivalent channels. An OC-3 SMARTRing^{®2} service (a.k.a. BellSouth Dedicated Ring) has 2,016 voice grade¹ (a.k.a. BellSouth SPA DS0 VG) equivalent channels. An OC-3+ or OC-12 SMARTRing^{®2} service (a.k.a. BellSouth Dedicated Ring) has 8,064 voice grade¹ equivalent channels. An OC-48 SMARTRing^{®2} service (a.k.a. BellSouth Dedicated Ring) or OC-48+ SMARTRing^{®2} service (a.k.a. BellSouth Dedicated Ring) with 48 or less activated DS3s has 32,256 voice grade¹ (a.k.a. BellSouth SPA DS0 VG) equivalent channels. However, when an OC-48+ SMARTRing^{®2} service (a.k.a. BellSouth Dedicated Ring) is used to transport BellSouth SWA service, and more than 48 equivalent DS3s are activated on the service, the factor will be based upon the actual number of activated DS3s times 672 DS0s. A factor for individual DS3 channel interfaces and 28 DS1 channel systems, will be derived by dividing the number of activated BellSouth SWA access circuits associated with the DS3 channel by the voice grade¹ (a.k.a. BellSouth SPA DS0 VG) equivalent capacity of the DS3 channel. A DS3 has 672 voice grade¹ (a.k.a. BellSouth SPA DS0 VG) equivalent channels. For DS1 channel interfaces, a factor is derived by dividing the number of BellSouth SWA access circuits associated with the DS1 channel by the voice grade¹ (a.k.a. BellSouth SPA DS0 VG) equivalent capacity of the DS1 channel, which is 24. Each reduction factor is rounded to four decimal places and then multiplied against the respective monthly charges to determine the reduction amount. (C)

BellSouth SWA rates and charges as set forth in E6.8 preceding will apply for each channel of the shared use facility that is used to provide BellSouth SWA.

E7.4.9 Reserved for Future Use

E7.4.10 Multijurisdictional WATS Access Line¹ (a.k.a. BellSouth SPA WATS Line) "1+" and "0" IntraLATA Usage

"1+" and "0" intraLATA usage carried over outward WATS Access Lines (a.k.a. BellSouth SPA WATS Line) having both intra and interstate capability (multijurisdictional) and provided from the BellSouth Telecommunications, Inc. Tariff FCC No. 1 or other appropriate Local Exchange Carrier (LEC) interstate tariff, will be completed over LEC facilities at LEC intraLATA outward WATS (a.k.a. BellSouth SPA WATS Line) rates and subject to rules and regulations applicable to LEC intraLATA outward WATS (a.k.a. BellSouth SPA WATS Line). The "1 +" and "0" intraLATA usage will be billed to the customer (end user or IXC) where the closed end of the Multijurisdictional WATS Access Line (a.k.a. BellSouth SPA WATS Line) is terminated. Customer billing information must be provided to the Company at the time the Multijurisdictional WATS Access Line (a.k.a. BellSouth SPA WATS Line) is ordered when the Company is used to complete intraLATA calls.

Note 1: Effective June 30, 2021, this Service will no longer be available for purchase by new or existing customers. In addition, requests to move, add, change, or renew existing service arrangements will not be accepted. Following the expiration of a customer's existing term agreement, service will be provided on a month-to-month basis at the applicable Monthly rates until the service is discontinued. The Company currently plans to discontinue this service on or after June 30, 2024.

Note 2: Effective on or after December 1, 2021, neither new nor existing customers will be permitted to purchase new SMARTRing Service (Service). In addition, (A) Service Payment Plans greater than 12-months in length will no longer be available; and (B) requests to move, add, change, upgrade, or downgrade existing service arrangements will not be accepted, with the following exceptions: (1) existing customers will be permitted to modify their existing Service and will be able to add new circuits to their existing Service, but will not be permitted to add new nodes in any locations; and (2) any such new circuits will be subject to the customer's existing term payment plan or term agreement for the Service to which they are added. Following the expiration of a customer's existing term agreement, Service will be provided on a month-to-month basis at the applicable Month-to-Month rates until the Service is discontinued. (N)

Effective November 30, 2023, unless specified to the contrary in their existing Service agreements, existing customers may not renew Term Payment Plans or term agreements for Service. In addition, no move, add, or change orders of any type will be accepted. (N)

E7. SPECIAL ACCESS (A.K.A. BELLSOUTH SPA) SERVICE

E7.4 Rate Regulations (Cont'd)

E7.4.11 Reserved for Future Use

E7.4.12 *BellSouth SPA Customer Network Management (CNM) - FlexServ Service* (T)

A. General

BellSouth SPA CNM - FlexServ service is an optional feature that enables the customer to monitor and reconfigure his Voice Grade (a.k.a. BellSouth SPA DS0 VG), DDAS (a.k.a. BellSouth SPA DS0 Digital Data), and High Capacity special access (a.k.a. BellSouth SPA High Capacity) services without the direct intervention of Company personnel. (T)

1. Basic ***BellSouth SPA CNM*** - FlexServ service (T)

Basic ***BellSouth SPA CNM*** - FlexServ service includes monitoring and reconfiguration of the customer's special access services equipped with ***BellSouth SPA CNM*** - FlexServ service. (T)

Monitoring consists of unsolicited signals of major and minor facility alarms. These alarms include carrier group alarms, out of service alarms, bit error rate, bipolar violations, slip errors, errored seconds, out-of-frame alarms and invalid connections. Invalid connections are connections between special access services with incompatible signals or between services without ***BellSouth SPA CNM*** - FlexServ service. Customer requests for such connections will be denied. The Company shall not be responsible for service interruptions, troubles, loss of customer data, or any other losses resulting from attempted invalid connections. (T)

Reconfiguration provides the customer with the ability to direct the Company to connect or disconnect circuits equipped with ***BellSouth SPA CNM*** - FlexServ service options to or from each others of like kind at a central office or central offices where the customer has purchased ***BellSouth SPA CNM*** - FlexServ service. Such connections and disconnections may be performed immediately or at a future time prescribed by the customer and are performed without direct interaction by Company personnel. (T)

The customer is responsible for providing the terminal equipment required for access to ***BellSouth SPA CNM*** - FlexServ service. (T)

The customer may transmit reconfiguration directions to or receive monitoring information from the Company over a switched service or a private line service. There are several types of access to the service listed in the General Subscriber Service Tariff from which the customer may choose. The type of access chosen will indicate the type of service the customer must provide to a Company location. Each ***BellSouth SPA CNM*** - FlexServ service customer must purchase at least one type of access. (T)

Outside of the Company exchange or region, the customer must provide service from his terminal location to the designated Company location from which he may receive monitoring information or transmit reconfiguration directions.

E7. SPECIAL ACCESS (A.K.A. BELLSOUTH SPA) SERVICE

E7.4 Rate Regulations (Cont'd)

E7.4.12 BellSouth SPA Customer Network Management (CNM) - FlexServ Service (Cont'd)

A. General (Cont'd)

1. Basic BellSouth SPA CNM - FlexServ service (Cont'd)

With the customer's initial order for basic BellSouth SPA CNM - FlexServ service, the Company provides the capability for "User Access" for monitoring and reconfiguration signals. One customer identification code with password security is included with such access.

With the customer's initial order, the Company provides one customer training class for up to five (5) persons. The class length of this initial training is two consecutive eight hour days. These training classes are conducted at a designated Company location. Transportation, lodging and food for the attendees will be the responsibility of the customer. If the customer desires for the initial training to be conducted on his premises, then the customer is responsible for the transportation, lodging and food for the trainer. In addition, the customer is responsible for having the appropriate equipment on his premises.

Reconfiguration and monitoring are not available during the performance of routine maintenance of the Company's facilities and equipment used to provide BellSouth SPA CNM - FlexServ service.

The Local and Interoffice Channels which are terminated into BellSouth SPA CNM - FlexServ service are subject to all regulations and charges contained in their respective sections of this Tariff in addition to those contained herein.

Different switching options may be available in the same central office. If customers desire more than one switching option in the same central office and facilities are available, a channel connection is required for each BellSouth SPA CNM - FlexServ service switching option connected.

BellSouth SPA CNM - FlexServ service is furnished only in serving wire centers where facilities are available.

2. Customer Circuits

There are three types of channel connections, which can be connected to BellSouth SPA CNM - FlexServ service - DS0 (single channel), DS1 (1.544 Mbps) and DS3 (44.736 Mbps) digital circuits.

DS0 Channel Connections - There are two types of DS0 channel connections - Voice Grade (a.k.a. BellSouth SPA DS0 VG) and Digital (a.k.a. BellSouth SPA DS0 Digital Data). Both types of DS0 connections will be switched at a DS0 level.

DS1 Channel Connections - There are two types of connections available for a customer desiring to terminate a DS1 circuit - DS0 switching and DS1 switching. For example, if a customer needs to be able to monitor or reconfigure the 24 DS0 circuits riding on the DS1 channel, then the customer would purchase a DS1 channel connection with DS0 switching. If the customer does not need access to the individual DS0 circuits, then the customer would purchase a DS1 channel connection with DS1 switching. A monitoring only option (i.e., surveillance) is also provided for DS1 channel connections. This option may also be used for terminating SWA DS1 channels.

DS3 Channel Connections (Monitoring Only) - There are two types of connections available for terminating a DS3 circuit - DS1 and DS3. This option provides for termination of SWA and SPA DS3 channels for monitoring purposes only (i.e., surveillance). If the customer needs monitoring for 28 DS1 circuits, then the customer would purchase a DS3 channel connection at DS1 level. The customer would purchase a DS3 channel connection at DS3 level if the customer wants to monitor the entire DS3 circuit.

3. BellSouth SPA CNM - FlexServ service Options

a. Additional Concurrent User Access: This option provides the customer the ability to establish additional concurrent connections to the Company for the communication of monitoring and reconfiguration signals. One additional customer identification code is provided with each additional User Access. For each Additional Concurrent User Access ordered, the customer must also order an additional Management Terminal Interface from the General Subscriber Service Tariff, A32.1.2.

b. Additional User Identification Codes: This option provides customer identification codes in addition to that provided with each User Access. If the customer has a Dial Access¹ to BellSouth SPA CNM - FlexServ service then the customer must also order an additional Security Card¹ from the General Subscriber Service Tariff, A32.1.2. (T)

Note 1: Effective November 1, 2008, the security card and dial access options are no longer available for new customer subscriptions. Existing customers may continue using these options but new orders will not be accepted. (N)

E7. SPECIAL ACCESS (A.K.A. BELLSOUTH SPA) SERVICE

E7.4 Rate Regulations (Cont'd)

E7.4.12 *BellSouth SPA Customer Network Management (CNM) - FlexServ Service (Cont'd)* (T)

A. General (Cont'd)

3. *BellSouth SPA CNM - FlexServ service Options (Cont'd)* (T)

c. **Additional Customer Training:** This option provides one eight hour day of customer training in addition to that included with basic *BellSouth SPA CNM - FlexServ* service. These training classes are conducted at a designated Company location. All other terms that apply for the initial training apply for the subsequent training. (T)

d. **Multipoint Bridging:** Multipoint Bridging is a capability which permits the cross connection of multiple channels equipped with *BellSouth SPA CNM - FlexServ* service. (T)

(1) **Multipoint Bridging**, sometimes referred to as "DMB", is an option on voice grade (a.k.a. BellSouth SPA DS0 VG) service that allows the customer the capability to perform reconfigurations that cross-connect or bridge three or more channels in the *BellSouth SPA CNM - FlexServ* service arrangement into one conferencing arrangement. (T)

(2) **Multipoint Junction Unit** option gives the customer the ability to bridge one master and four patron legs for use with Digital Data Access (a.k.a. BellSouth SPA DS0 Digital Data) service. If more than one MJU is required, one of the four patron legs must be used to connect to the master leg of another MJU. The customer is responsible for this connection. The MJU feature is only offered in a unit of five channel connections (one master and four legs). (T)

e. **Substrate Reconfiguration Capability** is an option that provides the customer the ability to control all ports of a substrate multiplexer within a *BellSouth SPA CNM - FlexServ* service arrangement. This control includes both the DS0B channel and DS0A legs. The speeds for substrates are 2.4, 4.8, and 9.6 Kbps (does not include 19.2 Kbps). The customer has the responsibility to establish a substrate system using previously acquired DS0 ports. (T)

f. **Reconfigurations by Company Personnel:** The customer may request that Company personnel intervene to perform reconfigurations that the customer could otherwise perform without the direct intervention of Company personnel. (T)

4. Shared *BellSouth SPA CNM - FlexServ* service Arrangement (T)

Multiple customers may include circuits with the *BellSouth SPA CNM - FlexServ* service option in the same FlexServ service arrangement, provided all customers designate in writing the same party to serve as their agent. A *BellSouth SPA CNM - FlexServ* service arrangement consists of all special access (a.k.a. BellSouth SPA) services with *BellSouth SPA CNM - FlexServ* service that can be monitored and reconfigured through the same User Access.) (T)

The agent will be authorized to represent each of those customers in all transactions and communications with the Company regarding the shared *BellSouth SPA CNM - FlexServ* service arrangement or circuits included in that arrangement including reconfigurations, monitoring, ordering of additional special access services and *BellSouth SPA CNM - FlexServ* service options in the arrangement, and removal of special access services from the arrangement. The Company will not process any customer orders or requests affecting that arrangement of circuits included in that arrangement except those submitted to the Company by the agent. (T)

The Company will not be liable for any loss to any of the customers in a shared *BellSouth SPA CNM - FlexServ* service arrangement caused directly or indirectly by actions of the agent or another customer in the shared arrangement. Each customer in the shared arrangement and the agent indemnify the Company for the costs of any and all claims arising directly or indirectly out of the actions of agent or another customer in the shared arrangement, including, but not limited to, the cost of defending against such claims. (T)

E7. SPECIAL ACCESS (A.K.A. BELLSOUTH SPA) SERVICE

E7.4 Rate Regulations (Cont'd)

E7.4.12 *BellSouth SPA Customer Network Management (CNM) - FlexServ Service (Cont'd)* (T)

A. General (Cont'd)

4. Shared *BellSouth SPA CNM - FlexServ Service Arrangement (Cont'd)* (T)

Any customer in a shared *BellSouth SPA CNM - FlexServ* service arrangement must give the Company thirty days prior written notice of his intent to revoke an agent's authority or to remove his special access (a.k.a. BellSouth SPA) services from a shared arrangement. Such notice shall not be effective unless it provides the Company with specific and sufficient directions regarding treatment of the customer's special access (a.k.a. BellSouth SPA) services upon revocation of the agent's authority or removal from the shared arrangement. (T)

5. Access Collocation Cross-Connects

Access Collocation Cross-Connects provides a means for customers to interconnect their *BellSouth SPA CNM - FlexServ* service to Central Office Collocation arrangements within the same Central Office. Terms, conditions, and rates for Physical Access Collocation Cross-Connects and Virtual Access Collocation Cross-Connects are set forth in Section E13. of this Tariff. (T)

B. Application of Rates

1. Basic *BellSouth SPA CNM - FlexServ Service* (T)

a. Connection of Special Access (a.k.a. BellSouth SPA) service to Reconfiguration and Alarm Monitoring Capability.

A DS0/DS1/DS3 nonrecurring Connection Charge and a recurring monthly rate is required for each entrance termination and exit termination of a special access channel to reconfiguration and monitoring capability.

Charges for Access to *BellSouth SPA CNM - FlexServ* service are contained in E7.5.16. (T)

2. *BellSouth SPA CNM - FlexServ Service Options* (T)

a. Additional Concurrent User Access

For each Additional Concurrent User Access a nonrecurring charge and a recurring monthly rate applies.

b. Additional User Identification Codes

A nonrecurring charge applies for each additional ID requested.

c. Additional Customer Training

Any additional training will incur a nonrecurring charge for each eight (8) hour day of training.

d. Multipoint Bridging

Multipoint Bridging (DMB)

There will be a nonrecurring charge and a monthly rate for each DS0 or equivalent that is equipped with this capability.

Multipoint Junction Unit

A nonrecurring charge and a monthly rate applies for each DS0 or equivalent that is equipped with this capability.

This option must be purchased in groups of five because a unit has the capacity of five DS0 or equivalent channel connections.

e. Subrate Reconfiguration

There will be a nonrecurring charge for each DS0 equipped DS0B and a nonrecurring charge and a monthly rate will apply for each set of DS0As. The DS0A rates apply in sets of five for 9.6 Kbps, in sets of ten for 4.8 Kbps, and in sets of twenty for 2.4 Kbps.

E7. SPECIAL ACCESS (A.K.A. BELLSOUTH SPA) SERVICE

E7.4 Rate Regulations (Cont'd)

E7.4.12 *BellSouth SPA Customer Network Management (CNM) - FlexServ Service (Cont'd)* (T)

- B. Application of Rates (Cont'd)
2. ***BellSouth SPA CNM - FlexServ Service Options (Cont'd)*** (T)
 - f. Reconfigurations by the Company Personnel

A nonrecurring charge is applicable on each occasion, when the customer requests Company personnel to perform a reconfiguration or a series of reconfigurations in order to set up point-to-point or multipoint connections, to provide a status report or to establish a conference.
- C. Payment Schedules
1. General
 - a. ***BellSouth SPA CNM - FlexServ service offers the following payment periods:*** (T)
 - Month-to-Month Payment Plan (One month option)
 - 24 to 48 Month Term Payment Plan
 - 49 to 72 Month Term Payment Plan
 - 73 to 96 Month Term Payment Plan
 - b. ***BellSouth SPA CNM - FlexServ service customers may select variable payment periods under the Term Payment Plan.*** (T)
 - c. The monthly rate for ***BellSouth SPA CNM - FlexServ service*** is dependent upon the payment period selected by the customer. (T)
 - d. The monthly rates for ***BellSouth SPA CNM - FlexServ service*** under the Term Payment Plan for the periods of 24 to 48, 49 to 72 and 73 to 96 months are not subject to the Company initiated rate changes. (T)
 2. Expiration of Payment Period
 - a. ***BellSouth SPA CNM - FlexServ service customers must upon the expiration of their payment period:*** (T)
 - (1) Select a new payment period as offered in the current tariff, or
 - (2) Revert to the current tariff rates for the one month payment option if the customer does not select a new payment period.
 - b. A ***BellSouth SPA CNM - FlexServ service customer*** may at any time during the selected payment period resubscribe for an equal or longer payment period at the current tariff rates subject to the following conditions: (T)
 - (1) No credit will be given for payments made during the formerly selected period. Nonrecurring charges and installation charges will not be reapplied.
 - (2) The new payment period begins with the billing date following the date the new payment period is requested.
 - (3) No termination charge applies for the former payment period.
 - c. A ***BellSouth SPA CNM - FlexServ service customer*** may at any time during his selected payment period resubscribe for a payment period, shorter in length than the time remaining in the existing service agreement, subject to the following conditions: (T)
 - (1) No credit will be given for payments made during the formerly selected period. Nonrecurring charges and installation charges will not be reapplied.
 - (2) The new payment period begins with the date requested.

E7. SPECIAL ACCESS (A.K.A. BELLSOUTH SPA) SERVICE

E7.4 Rate Regulations (Cont'd)

E7.4.12 *BellSouth SPA Customer Network Management (CNM) - FlexServ Service (Cont'd)*

- C. Payment Schedules (Cont'd)
 - 2. Expiration of Payment Period (Cont'd)
 - c. (Cont'd)
 - (3) A termination charge will be applied which represents the remaining amount of the longer contract less the total amount of the shorter contract. (Difference is the remaining amount of the original contract and the total amount to be paid with the shorter contract.)
 - 3. Termination Liability
 - a. The Termination Liability for *BellSouth SPA CNM - FlexServ* service is dependent upon the payment period selected by the customer.
 - (1) One Month Payment Plan - There is no termination liability for this option other than the initial service period as specified in A. preceding.
 - (2) Term Payment Plan Option - fifty percent (50%) of the remaining amount due.
 - 4. Allowance for Interruptions
 - a. When service is interrupted due to a failure or malfunction of *BellSouth SPA CNM - FlexServ* service, a pro rata adjustment of the appropriate *BellSouth SPA CNM - FlexServ* service monthly charges will be allowed at the request of the subscriber if the total system is unavailable for more than a twenty-four hour period and in accordance with the regulations specified in Section E2. of this Tariff.
 - b. No allowances will be granted for interruptions required to perform preventive or routine maintenance, or to perform software updates when the customer is notified at least twenty-four hours prior to such occurrences.

E7.4.13 **Derived Data Channel¹ (a.k.a. BellSouth SPA Derived Data Channel) Service (DDCS)**

(C)

- A. Application of Rates
 - 1. The Derived Data Local Channel (a.k.a. BellSouth SPA Derived Data Channel) charges provide the central office data/voice multiplexing capability.
 - a. The Derived Data Channel (a.k.a. BellSouth SPA Derived Data Channel) provides data transmission at the speed of 2.4 Kbps over an end user's existing two-wire exchange line (e.g., business exchange line, ESSX service main station line). The two-wire exchange line and its associated rates and charges apply in addition to the Derived Data Channel (a.k.a. BellSouth SPA Derived Data Channel) service rates and charges.
 - b. The DS0-B Interface charge is applicable for each group of a maximum of twenty multiplexed Derived Data Channels (a.k.a. BellSouth SPA Derived Data Channel). Each of the twenty channels in a DS0-B Interface Channel group operates at a bit rate of 2.4 Kbps and are multiplexed together to form a single 64 Kbps DS0 signal at the DS0-B Interface.
 - 2. Interoffice Channel
 - a. In addition to the Local Channel charges, the DS0-B Interoffice Channel may be required. The DS0-B Interoffice Channel is required to transport the 64 Kbps subrate multiplexed signal from the DS0-B Interface to the IC's serving wire center when the end user's serving wire center and the IC's serving wire center are not the same.
 - b. A four-wire Special Access (a.k.a. BellSouth SPA) digital facility is required to connect the DS0-B Interface to the IC's premises. Refer to Section E7. of this Tariff for applicable rates and charges.
 - 3. The DDCS (a.k.a. BellSouth SPA Derived Data Channel) nonrecurring charges include service ordering and installation charges associated with the DDCS (a.k.a. BellSouth SPA Derived Data Channel) equipment.

Note 1: Effective June 30, 2021, this Service will no longer be available for purchase by new or existing customers. In addition, requests to move, add, change, or renew existing service arrangements will not be accepted. Following the expiration of a customer's existing term agreement, service will be provided on a month-to-month basis at the applicable Monthly rates until the service is discontinued. The Company currently plans to discontinue this service on or after June 30, 2024.

(N)
|
(N)

E7. SPECIAL ACCESS (A.K.A. BELLSOUTH SPA) SERVICE

E7.4 Rate Regulations (Cont'd)

E7.4.14 SMARTRing[®] Service (a.k.a. BellSouth Dedicated Ring)

(C)

A. Self-healing Multi-nodal Alternate Route Topology Ring

1. Monthly rates and charges as specified in E7.5.17 following apply for each SMARTRing[®] service (a.k.a. BellSouth Dedicated Ring). Customers must specify network capacity at the time of the initial order. In an Overlay Ring Arrangement where a customer's overlaying SMARTRing service (a.k.a. BellSouth Dedicated Ring) rides the customer's host SMARTRing[®] service (a.k.a. BellSouth Dedicated Ring), the overlay ring will share the transport of the host ring between common node locations. Rate categories at OC-3, OC-3+, OC-12, OC-24, OC-48, OC-48+, OC-192 and OC-192+ capacity levels include Customer Nodes, Central Office Nodes, Local Channels, Alternate Central Office Channels, Interoffice Channels and Internodal Channels. OC-24 SMARTRing[®] service (a.k.a. BellSouth Dedicated Ring) is only available to existing CSPP customers or under month-to-month arrangements. Rate categories for OC-1 SMARTRing[®] service (a.k.a. BellSouth Dedicated Ring) include Customer Nodes and Central Office Nodes. Channel Interfaces are required at each node on the network and must be associated with a SMARTRing[®] service (a.k.a. BellSouth Dedicated Ring). An OC-1 Overlay Ring Arrangement requires an OC-1 Channel Interface at each node involved. An OC-3 Overlay Ring Arrangement requires an OC-3 Channel Interface at each node involved. An OC-3+ or OC-12 Overlay Ring Arrangement requires an OC-12 Channel Interface at each node involved. An OC-48 or OC-48+ Overlay Ring Arrangement requires an OC-48 Channel Interface at each node involved. In Overlay Ring Arrangements, the customer must order a Channel Interface for each entry to or exit from the host ring. In all other situations, the number of Channel Interfaces ordered will depend on whether the customer desires a working interface, or a working interface and a protection interface. The quantity of channel interfaces ordered may not exceed the capacity ordered. When a 28 DS1 Channel System is utilized to activate DS1 channels, the appropriate number of DS1 Channel Interfaces are required in lieu of an originating or terminating DS3 or STS-1 Channel Interface.
2. Nonrecurring charges for Local, Alternate Central Office, Interoffice and Internodal Channels apply for each channel for month-to-month customers. Nonrecurring charges are not applicable when the ring level rate elements and channel interfaces are ordered under TPP arrangements. SMARTRing[®] service (a.k.a. BellSouth Dedicated Ring) ring level rate elements are defined as following: Local Channel, Interoffice Channel, Internodal Channel, Alternate Central Office Channel, Customer Node and Central Office Node. Nonrecurring charges do apply for the Channel Interface Reallocation rate element and the SMARTRing[®] service (a.k.a. BellSouth Dedicated Ring) rearrangement rate elements (Surveillance and Reconfiguration) for CSPP and TPP customers. When the customer requests two separate routes and the routing is provided as described in E7.2.16.A preceding, charges apply for the Local Channels and any Interoffice Channels on the requested route. Recurring charges for Local, Alternate Central Office, Interoffice and Internodal Channels apply for each quarter air mile increment of the channel. Fractions of a quarter mile will always round up to the next quarter air mile before determining the mileage and applying the rate. For channels which are less than one quarter mile, a minimum charge of one quarter mile applies.
3. For Internodal Channels, charges apply as appropriate either for the same wire center area or contiguous serving wire center areas, as specified in E7.5.17.A.4.
4. Nonrecurring charges for Customer Nodes and Central Office Nodes apply per node for month-to-month customers and are based upon the capacity of the ring configuration. Nonrecurring charges are not applicable when the preceding rate elements are ordered under TPP arrangements. Recurring rates for Customer and Central Office Nodes apply per node and are also based upon the capacity of the ring configuration.

(M)

(N)

Note 1: Effective on or after December 1, 2021, neither new nor existing customers will be permitted to purchase new SMARTRing Service (Service). In addition, (A) Service Payment Plans greater than 12-months in length will no longer be available; and (B) requests to move, add, change, upgrade, or downgrade existing service arrangements will not be accepted, with the following exceptions: (1) existing customers will be permitted to modify their existing Service and will be able to add new circuits to their existing Service, but will not be permitted to add new nodes in any locations; and (2) any such new circuits will be subject to the customer's existing term payment plan or term agreement for the Service to which they are added. Following the expiration of a customer's existing term agreement, Service will be provided on a month-to-month basis at the applicable Month-to-Month rates until the Service is discontinued.

Effective November 30, 2023, unless specified to the contrary in their existing Service agreements, existing customers may not renew Term Payment Plans or term agreements for Service. In addition, no move, add, or change orders of any type will be accepted.

(N)

Material previously appearing on this page now appears on page(s) 40.2 of this section.

All BellSouth marks contained herein are owned by BellSouth Intellectual Property Corporation

E7. SPECIAL ACCESS (A.K.A. BELLSOUTH SPA) SERVICE

E7.4 Rate Regulations (Cont'd)

E7.4.14 SMARTRing^l Service (a.k.a. BellSouth Dedicated Ring) (Cont'd)

(C)

A. Self-healing Multi-nodal Alternate Route Topology Ring (Cont'd)

5. When the customer orders an OC-1 SMARTRing[®] service (a.k.a. BellSouth Dedicated Ring) Overlay Ring Arrangement riding the customer's host OC-12, OC-48, or OC-48+ SMARTRing[®] service (a.k.a. BellSouth Dedicated Ring), recurring charges apply per OC-1 Customer Node and/or OC-1 Central Office Node, in addition to the recurring and nonrecurring charges for associated Channel Interfaces. (M1)
6. When the customer orders an OC-3 SMARTRing[®] service (a.k.a. BellSouth Dedicated Ring) service Overlay Ring Arrangement riding the customer's host OC-12, OC-48, OC-48+, OC-192 or OC-192+ SMARTRing[®] service (a.k.a. BellSouth Dedicated Ring), recurring charges apply per OC-3 Customer Node and/or OC-3 Central Office Node, in addition to the recurring and nonrecurring charges for associated Channel Interfaces. Nonrecurring charges only apply for month-to-month customers. (M1)
7. When the customer orders an OC-3+ or OC-12 Overlay Ring Arrangement riding the customer's host OC-48, OC-48+, OC-192 or OC-192+ SMARTRing[®] service (a.k.a. BellSouth Dedicated Ring), recurring charges apply per OC-3+ and/or OC-12 Customer Node and/or per OC-3+ and/or OC-12 Central Office Node, in addition to the charges for associated Channel Interfaces. Nonrecurring charges only apply for month-to-month customers. (M1)
8. In all Overlay Ring Arrangements, the number of OC-1, OC-3, OC-12 and/or OC-48 Channel Interfaces required will be based upon the characteristics of the overlaying ring. (M1)
9. The rates for Customer Channel Interfaces apply for each origination and for each termination of an activated DS1, DS3, STS-1, OC-3, OC-12, OC-48 and/or 1000 Mbps at the Customer Node. For interfaces ordered on a month-to-month basis the nonrecurring charge applies per interface. For interfaces ordered under CSPP, nonrecurring charges are established on a per order basis for the first DS1, DS3, STS-1, OC-3 and/or OC-12 which originates or terminates at a Customer Node and for each additional DS1, DS3, STS-1, OC-3, and/or OC-12 which originates or terminates at the same Customer Node. For interfaces ordered under TPP, there are no nonrecurring charges associated with the installation. The recurring rate applies on a per Customer Node basis for each origination and for each termination of an activated DS3 and/or DS1 at a Customer Node.
10. In addition, OC-12 and or OC-48 customers with DS3 and/or STS-1 interfaces at the Customer Node electing to connect with DS1 services at a Central Office Node, must obtain a 28 DS1 Channel System and the appropriate number of DS1 Channel Interfaces in lieu of a DS3 or STS-1 Channel Interface. A maximum of 28 DS1 Channel Interfaces can be activated for each 28 DS1 Channel System utilized. For service ordered under CSPP, nonrecurring charges are established on a per order basis for the first 28 DS1 Channel System and for each additional 28 DS1 Channel System at that same Central Office Node. Nonrecurring charges are also established for the first DS1 Channel Interface which originates/terminates in a 28 DS1 Channel System and each additional DS1 Channel Interface which originates/terminates in that same DS1 Channel System. For DS1 Channel Systems ordered under TPP, nonrecurring charges do not apply. For DS1 Channel Systems ordered on a month-to-month basis, nonrecurring charges apply. The recurring rate applies for each 28 DS1 Channel System and each DS1 Channel Interface activated per Central Office Node. (M2)

(M2)

(N)

Note 1: Effective on or after December 1, 2021, neither new nor existing customers will be permitted to purchase new SMARTRing Service (Service). In addition, (A) Service Payment Plans greater than 12-months in length will no longer be available; and (B) requests to move, add, change, upgrade, or downgrade existing service arrangements will not be accepted, with the following exceptions: (1) existing customers will be permitted to modify their existing Service and will be able to add new circuits to their existing Service, but will not be permitted to add new nodes in any locations; and (2) any such new circuits will be subject to the customer's existing term payment plan or term agreement for the Service to which they are added. Following the expiration of a customer's existing term agreement, Service will be provided on a month-to-month basis at the applicable Month-to-Month rates until the Service is discontinued.

Effective November 30, 2023, unless specified to the contrary in their existing Service agreements, existing customers may not renew Term Payment Plans or term agreements for Service. In addition, no move, add, or change orders of any type will be accepted. (N)

(N)

E7. SPECIAL ACCESS (A.K.A. BELLSOUTH SPA) SERVICE

E7.4 Rate Regulations (Cont'd)

E7.4.14 SMARTRing^{®3} service (a.k.a. BellSouth Dedicated Ring) (Cont'd)

- A. Self-healing Multi-nodal Alternate Route Topology Ring (Cont'd)
11. A nonrecurring charge applies for SMARTRing service (a.k.a. BellSouth Dedicated Ring) Surveillance, one for each Customer Node and each Central Office Node, per SMARTRing service (a.k.a. BellSouth Dedicated Ring) rearranged. A nonrecurring charge applies for Reconfiguration, one per reconfiguration of each STS-1 group at each node where such reconfiguration capability is desired. These rate elements apply when the Customer adds BellSouth SPA CNM - FlexServ service to an existing SMARTRing service (a.k.a. BellSouth Dedicated Ring) as set forth in E7.2.16.A preceding. Reconfiguration is not available with 100 Mbps and 1000 Mbps BellSouth Metro Ethernet² Backbone interfaces. (M1)
 12. For CSPP customers, first and additional nonrecurring charges will be applied when ordering the same rate element between the same locations with the same installation date. First and additional nonrecurring charges are not applicable under TPP arrangements. (M1)
 13. SMARTRing service (a.k.a. BellSouth Dedicated Ring) purchased prior to August 23, 1996, is available under several CSPP arrangements: Plan A (24-48 Months³), Plan B (49-72 Months³) or Plan C (73-96 Months³)¹. Renewals of existing SMARTRing service (a.k.a. BellSouth Dedicated Ring) or purchases of new SMARTRing service (a.k.a. BellSouth Dedicated Ring) on or after August 23, 1996, will only be available under TPP arrangements. In order to accommodate more flexible customer situations, SMARTRing service (a.k.a. BellSouth Dedicated Ring) is available under several TPP arrangements: Plan A (12-36 Months³), Plan B (37-60 Months³) or Plan C (61-96 Months³)¹. Month-to-month arrangements (with a minimum of four months) are available for SMARTRing service (a.k.a. BellSouth Dedicated Ring). (M1)(C)
 14. CSPP and TPP arrangements are provided under the terms and conditions specified in E2.4.9 preceding, except as modified following. For all payment plans, the following regulations apply: (M1)
 - a. SMARTRing service (a.k.a. BellSouth Dedicated Ring), whether initially or subsequently ordered in conjunction with BellSouth Dedicated Ring, must be provided under the same TPP payment plan with the same service period and both services are to be coterminous. (M1)
 - b. All rate elements, for a given SMARTRing service (a.k.a. BellSouth Dedicated Ring), whether initially or subsequently ordered, must be provided under the same payment plan with the same service period and are coterminous upon disconnect of the SMARTRing service (a.k.a. BellSouth Dedicated Ring). However, Channel Interfaces, except those utilized to interface an overlaying ring with its host ring, may be provided under a month-to-month arrangement which is equal to or less than the payment plan for the associated SMARTRing service (a.k.a. BellSouth Dedicated Ring). Customers with Channel Interfaces provided under a CSPP payment period which began prior to August 22, 1994, may convert those Channel Interfaces to a month-to-month or payment plan arrangement which is equal to or less than the payment plan for the associated SMARTRing service (a.k.a. BellSouth Dedicated Ring), at the current rates and charges. (M1)
 - c. In a shared network arrangement, where the host subscriber and the connecting service user subscribes to services under CSPP or TPP arrangements, the payment periods for directly associated channelized rate elements must be equal to or less than the payment periods for the host service, or the service user must order those rate elements under month-to-month payment terms. Where the host subscriber receives services under month-to-month payment terms, a connecting user must also receive directly associated channelized rate elements under month-to-month payment terms. (M2)

Note 1: All term plans for SMARTRing[®] Service which are established, renewed or extended after December 10, 2013, for term lengths which are scheduled to expire at any time after February 1, 2019, will instead expire on February 1, 2019. All such services existing on or after February 1, 2019, will be provided on a month-to-month basis at the applicable, then current month-to-month rates. (M1)

Note 2: Effective on or after August 22, 2021, this Service will no longer be available for purchase by new or existing customers. In addition, requests to move, add, change, or renew existing service arrangements will not be accepted. Following the expiration of a customer's existing term agreement, service will be provided on a month-to-month basis at the applicable Monthly rates until the service is discontinued. The Company currently plans to discontinue this service on or after March 31, 2023. (M1)

Note 3: Effective on or after December 1, 2021, neither new nor existing customers will be permitted to purchase new SMARTRing Service (Service). In addition, (A) Service Payment Plans greater than 12-months in length will no longer be available; and (B) requests to move, add, change, upgrade, or downgrade existing service arrangements will not be accepted, with the following exceptions: (1) existing customers will be permitted to modify their existing Service and will be able to add new circuits to their existing Service, but will not be permitted to add new nodes in any locations; and (2) any such new circuits will be subject to the customer's existing term payment plan or term agreement for the Service to which they are added. Following the expiration of a customer's existing term agreement, Service will be provided on a month-to-month basis at the applicable Month-to-Month rates until the Service is discontinued. (N)

Effective November 30, 2023, unless specified to the contrary in their existing Service agreements, existing customers may not renew Term Payment Plans or term agreements for Service. In addition, no move, add, or change orders of any type will be accepted. (N)

M1 Material appearing on this page previously appeared on page(s) 40.2 of this section.

M2 Material previously appearing on this page now appears on page(s) 42 of this section.

[®] Registered Service Mark of BellSouth Corporation

E7. SPECIAL ACCESS (A.K.A. BELL SOUTH SPA) SERVICE

E7.4 Rates Regulations (Cont'd)

E7.4.14 SMARTRing[®] service (a.k.a. BellSouth Dedicated Ring) (Cont'd)

15. The rates applicable to a month-to-month payment plan are subject to Company initiated charges. (M)
16. For CSPP customers, a termination liability charge will be applicable if services are disconnected prior to the end of the chosen service period. The applicable charge is equal to the number of months remaining in the rate stabilized service period times 60 percent of the monthly rates for SMARTRing[®] service (a.k.a. BellSouth Dedicated Ring) which includes all Nodes, Channel Interfaces, Local Channels, Alternate Central Office Channels, Internodal Channels and/or Interoffice Channels provided under the CSPP arrangement. (M)
- Termination liability charges for SMARTRing[®] service (a.k.a. BellSouth Dedicated Ring) TPP customers are applicable as specified in E2.4.9.C preceding. (M)
17. When a service period under an existing CSPP or TPP arrangement is completed and a customer elects to revert to a month-to-month payment option, no minimum period is applicable. (M)
18. The TPP customer of record will have a 60 day grace period after which month-to-month rates will apply. (M)
19. Customers may upgrade from a lower capacity SMARTRing[®] service (a.k.a. BellSouth Dedicated Ring) to a higher capacity SMARTRing[®] service (a.k.a. BellSouth Dedicated Ring) without incurring any termination charges if the following conditions are met: (M)
- a. the order for the upgraded SMARTRing[®] service (a.k.a. BellSouth Dedicated Ring) and the order for the disconnect of the existing SMARTRing[®] service (a.k.a. BellSouth Dedicated Ring) are received by the Company at the same time, (M)
 - b. the new SMARTRing[®] service (a.k.a. BellSouth Dedicated Ring) is provided between the same customer and Central Office locations as the discontinued SMARTRing[®] service (a.k.a. BellSouth Dedicated Ring), (M)
 - c. the number of Channel Interfaces activated under the new capacity SMARTRing[®] service (a.k.a. BellSouth Dedicated Ring) is greater than the number of Channel Interfaces activated under the existing capacity SMARTRing[®] service (a.k.a. BellSouth Dedicated Ring). (M)
 - d. the expiration date of the new SMARTRing[®] service (a.k.a. BellSouth Dedicated Ring) payment plan is subsequent to the payment plan of the ring being discontinued. (M)
20. Customers may also upgrade existing SMARTRing[®] service (a.k.a. BellSouth Dedicated Ring) to a new SMARTRing[®] service (a.k.a. BellSouth Dedicated Ring) of the same capacity without incurring a termination liability charge, if the customer is concurrently ordering a new capability which cannot be provisioned with the existing SMARTRing[®] service (a.k.a. BellSouth Dedicated Ring) and if the conditions set forth in 19. preceding are met. (M)
21. Ring level billing is defined as billing for the following rate elements: Local Channel, Interoffice Channel, Internodal Channel Alternate Central Office Channel, Customer Node and Central Office Node. Billing for Customer Channel Interfaces and Central Office Channel Interfaces recurring and nonrecurring charges will be effective upon activation to the SMARTRing[®] service (a.k.a. BellSouth Dedicated Ring). (M)
22. If the Service Establishment Date extends beyond one year from the customer's order date due to Company reasons, the preceding conversion provisions apply. If the Service Establishment Date extends beyond one year from the customer's order date for other reasons, the preceding conversion provisions do not apply and billing for all recurring and nonrecurring charges will be effective with the Service Establishment Date. (M)

E7.4.15 Reserved for Future Use

E7.4.16 Reserved for Future Use

Note 1: Effective on or after December 1, 2021, neither new nor existing customers will be permitted to purchase new SMARTRing Service (Service). In addition, (A) Service Payment Plans greater than 12-months in length will no longer be available; and (B) requests to move, add, change, upgrade, or downgrade existing service arrangements will not be accepted, with the following exceptions: (1) existing customers will be permitted to modify their existing Service and will be able to add new circuits to their existing Service, but will not be permitted to add new nodes in any locations; and (2) any such new circuits will be subject to the customer's existing term payment plan or term agreement for the Service to which they are added. Following the expiration of a customer's existing term agreement, Service will be provided on a month-to-month basis at the applicable Month-to-Month rates until the Service is discontinued. (N)

Effective November 30, 2023, unless specified to the contrary in their existing Service agreements, existing customers may not renew Term Payment Plans or term agreements for Service. In addition, no move, add, or change orders of any type will be accepted. (N)

E7. SPECIAL ACCESS (A.K.A. BELLSOUTH SPA) SERVICE

E7.4 Rate Regulations (Cont'd)

- E7.4.17 Reserved For Future Use (N)
- E7.4.18 Reserved For Future Use (N)
- E7.4.19 Reserved For Future Use (N)
- E7.4.20 Reserved For Future Use (N)
- E7.4.21 Reserved For Future Use (N)
- E7.4.22 Reserved For Future Use (N)
- E7.4.23 Reserved For Future Use (N)
- E7.4.24 Reserved For Future Use (N)
- E7.4.25 Reserved For Future Use (N)
- E7.4.26 Reserved For Future Use (N)
- E7.4.27 Reserved For Future Use (N)
- E7.4.28 Reserved For Future Use (N)
- E7.4.29 Reserved For Future Use (N)
- E7.4.30 Reserved For Future Use (N)
- E7.4.31 Reserved For Future Use (N)

E7. SPECIAL ACCESS (A.K.A. BELLSOUTH SPA) SERVICE

E7.4 Rate Regulations (Cont'd)

E7.4.32 BellSouth Metro Ethernet Service¹

(C)

A. General

1. The minimum service period for BellSouth Metro Ethernet service is four (4) months.
2. Suspension of BellSouth Metro Ethernet service is not allowed.
3. BellSouth Metro Ethernet service is available 24 hours per day, 7 days per week, except for preventive maintenance.

Due to the nature of BellSouth Metro Ethernet service it will be necessary to perform preventive maintenance and software updates. This will mean that BellSouth Metro Ethernet service will be unavailable during the period of time when preventive maintenance is being performed. This could result in the service being unavailable during the period between 1:00 AM and 5:00 AM Eastern Time on Sundays and Saturdays. However, the Company reserves the right to perform maintenance at any time at its discretion that it believes such maintenance is necessary. The Company will make a reasonable effort to provide notice to those customers likely to be affected by such maintenance work.

4. Obligations of customer and Company:
 - (a) The Company is not responsible for the installation, operation or maintenance of any equipment provided by the customer.
 - (b) The customer is responsible for the provision and maintenance of all customer provided equipment and to insure that the operating characteristics of this equipment is comparable with and does not interfere with the service offered by the Company.
 - (c) At the BellSouth Metro Ethernet service Connection point the customer's signals must conform to IEEE Standards 802.3, 802.3u or 802.3z. To meet end-to-end delay requirements contained in these aforementioned standards, the customer may be required to provide additional equipment.
5. In some cases, the Company and another Incumbent Local Exchange Company (ILEC) may agree to jointly provide a customer Metro Ethernet Service. The rates and charges for the BellSouth Metro Ethernet service Connection are applicable for such connectivity; charges for BellSouth Metro Ethernet Additional Mileage are also applicable when the mileage from the BellSouth/ILEC meet-point to the BellSouth Metro Ethernet wire center associated with the service is over ten (10) miles. The Company is only responsible for the ordering, provisioning, maintaining and billing of such service up to the meet-point (i.e., demarcation point with the ILEC). BellSouth Metro Ethernet service SLA credits shall only be applicable for the portion of the service provided within the territory of the Company; such credits are appropriate only for missed commitments determined to be the fault of the Company.

Note 1: Effective on or after August 22, 2021, this Service will no longer be available for purchase by new or existing customers. In addition, requests to move, add, change, or renew existing service arrangements will not be accepted. Following the expiration of a customer's existing term agreement, service will be provided on a month-to-month basis at the applicable Monthly rates until the service is discontinued. The Company currently plans to discontinue this service on or after March 31, 2023.

(N)

(N)

E7. SPECIAL ACCESS (A.K.A. BELLSOUTH SPA) SERVICE

E7.4 Rate Regulations (Cont'd)

E7.4.32 BellSouth Metro Ethernet Service¹

A. General (Cont'd)

- 6. Basic, Premium and Virtual BellSouth Metro Ethernet Service Connections of 10 Mbps or higher may alternatively be provided to a customer premises over the customer’s SMARTRing² service (a.k.a. BellSouth SPA Dedicated Ring). (C)
 The customer is required to purchase the appropriate SMARTRing² service (a.k.a. BellSouth SPA Dedicated Ring) BellSouth Metro Ethernet Backbone interfaces that are a bandwidth equal to the bandwidth of the BellSouth Metro Ethernet Service backbone transport that is standard for the specific type and speed of BellSouth Metro Ethernet Service Connection serving that customer premises. (A chart is provided herein which sets forth the backbone bandwidth of each type and speed of BellSouth Metro Ethernet Service Connection.) Standard BellSouth Metro Ethernet Service features are available on such alternative arrangements, with the exception that Automatic Protection Switching is not available. (C)
 For such applications using SMARTRing² service (a.k.a. BellSouth SPA Dedicated Ring) as alternate transport, the BellSouth Metro Ethernet Service Connection will provide data channel transport to connect the termination of the SMARTRing² service (a.k.a. BellSouth SPA Dedicated Ring) at the central office node, to the BellSouth Metro Ethernet Service wire center associated with the BellSouth Metro Ethernet Service Connection (i.e., the central office of the Metro Ethernet Service switch). (C)
 When the SMARTRing² service (a.k.a. BellSouth SPA Dedicated Ring) central office node is located greater than 10 miles from the BellSouth Metro Ethernet Service wire center, BellSouth Metro Ethernet Service Additional Mileage charges will also be applicable. (C)
 For BellSouth Metro Ethernet Service Connections utilizing the customer’s LightGate service or SMARTRing² service as alternate transport, the committed bandwidth for select speeds will be as shown in BellSouth Technical Reference TR-73632. (C)

<u>Metro Ethernet Connection</u>	<u>Metro Ethernet Backbone Bandwidth</u>
Basic 10 Mbps	100 Mbps (1 STS-1)
Basic 100 Mbps	100 Mbps (3 STS-1)
Basic 1000 Mbps	1000 Mbps
Premium 10, 20, 50 Mbps (Fixed)	100 Mbps (1 STS-1)
Premium 10, 20, 50 Mbps (Burst)	100 Mbps (3 STS-1)
Premium 100 Mbps (Fixed)	Fractional 1000 Mbps at 150 Mbps
Premium 250 Mbps (Fixed)	Fractional 1000 Mbps at 300 Mbps
Premium 500 Mbps (Fixed)	Fractional 1000 Mbps at 600 Mbps
Premium 900 Mbps (Fixed)	1000 Mbps
Premium 100, 250, 500 Mbps (Burst)	1000 Mbps
Virtual 10, 20, 50 Mbps	100 Mbps (1 STS-1)
Virtual 80 Mbps	100 Mbps (3 STS-1)
Virtual 100 Mbps	Fractional 1000 Mbps at 150 Mbps
Virtual 200, 300 Mbps	Fractional 1000 Mbps at 300 Mbps
Virtual 450 Mbps	Fractional 1000 Mbps at 450 Mbps
Virtual 600 Mbps	Fractional 1000 Mbps at 600 Mbps
Virtual 750, 900 Mbps	1000 Mbps

Note 1: Effective on or after August 22, 2021, this Service will no longer be available for purchase by new or existing customers. In addition, requests to move, add, change, or renew existing service arrangements will not be accepted. Following the expiration of a customer's existing term agreement, service will be provided on a month-to-month basis at the applicable Monthly rates until the service is discontinued. The Company currently plans to discontinue this service on or after March 31, 2023.

Note 2: Effective on or after December 1, 2021, neither new nor existing customers will be permitted to purchase new SMARTRing Service (Service). In addition, (A) Service Payment Plans greater than 12-months in length will no longer be available; and (B) requests to move, add, change, upgrade, or downgrade existing service arrangements will not be accepted, with the following exceptions: (1) existing customers will be permitted to modify their existing Service and will be able to add new circuits to their existing Service, but will not be permitted to add new nodes in any locations; and (2) any such new circuits will be subject to the customer's existing term payment plan or term agreement for the Service to which they are added. Following the expiration of a customer's existing term agreement, Service will be provided on a month-to-month basis at the applicable Month-to-Month rates until the Service is discontinued. (N)

Effective November 30, 2023, unless specified to the contrary in their existing Service agreements, existing customers may not renew Term Payment Plans or term agreements for Service. In addition, no move, add, or change orders of any type will be accepted. (N)

E7. SPECIAL ACCESS (A.K.A. BELLSOUTH SPA) SERVICE

E7.4 Rate Regulations (Cont'd)

E7.4.32 BellSouth Metro Ethernet Service (Cont'd)¹

A. General (Cont'd)

7. In some cases, the Telephone Company and an Independent Telephone Company (ICO) may agree to jointly provide a customer Metro Ethernet Service. The rates and charges for the BellSouth Metro Ethernet Service Connection are applicable for such connectivity; charges for BellSouth Metro Ethernet Additional Mileage are also applicable when the mileage from the BellSouth/ICO meet-point to the BellSouth Metro Ethernet wire center associated with the service is over 10 miles. The Telephone Company is only responsible for the ordering, provisioning, maintaining and billing of such service up to the meet-point (i.e., demarcation point with the ICO). BellSouth Metro Ethernet Service SLA credits shall only be applicable for the portion of the service provided within the territory of the Telephone Company; such credits are appropriate only for missed commitments determined to be the fault of the Telephone Company.

(C)
 (M)
 |
 (M)

B. Rate Categories and Regulations

1. The following rate categories apply for BellSouth Metro Ethernet service. Applicable rates and charges are provided in E7.5.22 following.
 - (a) Basic BellSouth Metro Ethernet service Connection
 - (b) Premium BellSouth Metro Ethernet service Connection
 - (c)
 - (d) Virtual BellSouth Metro Ethernet service Connection
 - (e) BellSouth Metro Ethernet service Additional Mileage Charge
 - (f) Priority Plus Feature
 - (g) Q-Forwarding Feature
 - (h) VLAN Aggregation Feature
 - (i) *CNM* - Metro Ethernet Reporting Feature
 - (j) Class of Service (CoS) Profile
 - (k) Automatic Protection Switching Feature
 - (l) Service Reconfiguration Charge
 - (m) System Reconfiguration Charge
2. BellSouth Metro Ethernet service is available under month-to-month rates as provided in E7.5.22.A. following or under the optional Transport Payment Plan (TPP) (as described in E2.4.9.C. of this Tariff) to receive the TPP rates provided in E7.5.22.B. following.
3. BellSouth Metro Ethernet service Connections are provided utilizing various Ethernet equipment configurations referred to herein as "physical service types". The physical service type of each BellSouth Metro Ethernet Connection is provided in the chart in 5. following.
4. A hierarchy of the various BellSouth Metro Ethernet service Connections by capability (i.e., basic, premium and virtual) and speed is provided in the chart in 5. following. This chart provides a higher order of service ranking that is utilized to determine the appropriate nonrecurring charges for service reconfiguration requests. This ranking is also utilized to determine if termination liability is applicable for specific reconfiguration requests if the service is under a TPP term commitment.

(M) Material appearing on this page previously appeared on page 42.2.1.

Note 1: Effective on or after August 22, 2021, this Service will no longer be available for purchase by new or existing customers. In addition, requests to move, add, change, or renew existing service arrangements will not be accepted. Following the expiration of a customer's existing term agreement, service will be provided on a month-to-month basis at the applicable Monthly rates until the service is discontinued. The Company currently plans to discontinue this service on or after March 31, 2023.

(N)
 |
 (N)

E7. SPECIAL ACCESS (A.K.A. BELLSOUTH SPA) SERVICE

E7.4 Rate Regulations (Cont'd)

E7.4.32 BellSouth Metro Ethernet Service (Cont'd)³

(C)

B. Rate Categories and Regulations (Cont'd)

5. The following informational chart provides the physical service type of each BellSouth Metro Ethernet Connection and provides the other BellSouth Metro Ethernet Connections which are considered to be a higher order of service (BellSouth Metro Ethernet service hierarchy).

Metro Ethernet Connection (Mbps):	Physical Service Type:	Higher Order of Service (Mbps):
- Basic 2	Basic 0	Basic 4,8,10,100,1000; Premium ¹ 2, 4, 8,10,20,50,100,250,500; Virtual 2,4,8,10,20,50,80,100,200,300,450,600,750,900
- Basic 4	Basic 0	Basic 8,10,100,1000; Premium ¹ 4, 8,10,20,50,100,250,500; Virtual 4,8,10,20,50,80,100,200,300,450,600,750,900
- Basic 8	Basic 0	Basic 10,100,1000; Premium ¹ 8,10,20,50,100,250,500; Virtual 8,10,20,50,80,100,200,300,450,600,750,900
- Basic 10	Basic I	Basic 100,1000; Premium ¹ 10,20,50,100,250,500,900 ² ; Virtual 10,20,50,80,100, 200,300,450,600,750,900
- Basic 100	Basic II	Basic 1000; Premium ¹ 100,250,500,900 ² ; Virtual 80, 100,200,300,450,600,750,900
- Basic 1000	Basic III	Premium ¹ 500,900 ² ; Virtual 450,600,750,900
- Premium 2	Premium 0	Basic 100,1000; Premium ¹ 4,8,10,20,50,100,250,500; Virtual 2,4,8,10,20,50,80,100,200,300,450,600,750,900
- Premium 4	Premium 0	Basic 100,1000; Premium ¹ 8,10,20,50,100,250,500; Virtual 4,8,10,20,50,80,100,200,300,450,600,750,900
- Premium 8	Premium 0	Basic 100,1000; Premium ¹ 10,20,50,100,250,500; Virtual 8,10,20,50,80,100,200,300,450,600,750,900
- Premium ¹ 10	Premium I	Basic 1000; Premium ¹ 20,50,100,250,500,900 ² ; Virtual 10,20,50,80,100,200,300, 450,600,750,900
- Premium ¹ 20	Premium I	Basic 1000; Premium ¹ 50,100,250,500,900 ² ; Virtual 20,50,80,100,200,300,450, 600,750,900
- Premium ¹ 50	Premium I	Premium ¹ 100,250,500,900 ² ; Virtual 50,80,100,200, 300,450,600,750,900
- Premium ¹ 100	Premium II	Premium ¹ 250,500,900 ² ; Virtual 100,200,300,450,600,750,900
- Premium ¹ 250	Premium II	Premium ¹ 500,900 ² ; Virtual 300,450,600,750,900
- Premium ¹ 500	Premium II	Premium 900 ² ; Virtual 450,600,750,900
- Premium 900 ²	Premium II	Virtual 900
- Virtual 2	Virtual 0	Basic 100,1000; Premium ¹ 10,20,50,100,250,500; Virtual 4,8,10,20,50,80,100,200,300,450,600,750,900
- Virtual 4	Virtual 0	Basic 100,1000; Premium ¹ 10,20,50,100,250,500; Virtual 8,10,20,50,80,100,200,300,450,600,750,900
- Virtual 8	Virtual 0	Basic 100,1000; Premium ¹ 10,20,50,100,250,500; Virtual 10,20,50,80,100,200,300,450,600,750,900
- Virtual 10	Virtual I	Basic 1000; Premium ¹ 20,50,100,250,500,900 ² ; Virtual 20,50,80,100,200,300,450, 600, 750,900
- Virtual 20	Virtual I	Basic 1000; Premium ¹ 50,100,250,500,900 ² ; Virtual 50,80,100,200,300,450,600,750,900
- Virtual 50	Virtual II	Basic 1000; Premium ¹ 100,250,500,900 ² ; Virtual 80, 100,200,300,450,600,750,900
- Virtual 80	Virtual II	Basic 1000; Premium ¹ 100,250,500,900 ² ; Virtual 100, 200,300,450,600,750,900
- Virtual 100	Virtual II	Premium ¹ 250,500,900 ² ; Virtual 200,300,450,600,750,900
- Virtual 200	Virtual II	Premium ¹ 500,900 ² ; Virtual 300,450,600,750,900
- Virtual 300	Virtual II	Premium ¹ 500,900 ² ; Virtual 450,600,750,900
- Virtual 450	Virtual II	Premium 900 ² ; Virtual 600,750,900
- Virtual 600	Virtual II	Premium 900 ² ; Virtual 750,900
- Virtual 750	Virtual II	Premium 900 ² ; Virtual 900
- Virtual 900	Virtual II	None offered at this time

Note in the above chart that the reference to Basic 1000 Mbps refers to Basic 1 Gbps.

Note 1: Fixed Mode or Burst Mode.

Note 2: Premium 900 Mbps only available as Fixed Mode.

Note 3: Effective on or after August 22, 2021, this Service will no longer be available for purchase by new or existing customers. In addition, requests to move, add, change, or renew existing service arrangements will not be accepted. Following the expiration of a customer's existing term agreement, service will be provided on a month-to-month basis at the applicable Monthly rates until the service is discontinued. The Company currently plans to discontinue this service on or after March 31, 2023.

(N)
|
(N)

E7. SPECIAL ACCESS (A.K.A. BELLSOUTH SPA) SERVICE

E7.4 Rate Regulations (Cont'd)

E7.4.32 BellSouth Metro Ethernet Service (Cont'd)¹

(C)

B. Rate Categories and Regulations (Cont'd)

6. A BellSouth Metro Ethernet reconfiguration nonrecurring charge is applicable for a customer request to reconfigure (rearrange) an existing BellSouth Metro Ethernet Connection. The appropriate reconfiguration charge is dependent upon the physical work required to fulfill the request and applies in lieu of other nonrecurring charges.

A Service Reconfiguration Charge is applicable for requests where the work required is a minor change that does not involve changing the physical service type. The Service Reconfiguration Charge is applicable for a request to change an existing connection to a different connection that is the same physical service type *that is a lower order of service*, is applicable for a request to change a Premium connection from fixed mode to burst mode (and vice versa) and is applicable for a request to change a Premium connection to add or delete the Priority Plus feature. The Service Reconfiguration Charge is also applicable for changing an existing Virtual connection CoS Profile.

A System Reconfiguration Charge is applicable for requests where the work required involves changing to a different physical service type or involves major support system changes. The System Reconfiguration Charge is applicable for requests to change an existing connection to a different connection that is a different physical service type *that is a lower order of service*, to change the network channel terminating equipment (NCTE) interface option from optical to electrical (or vice-versa), and to change the premises powering options from AC power to DC power (or vice-versa).

7. **(DELETED)**

Note 1: Effective on or after August 22, 2021, this Service will no longer be available for purchase by new or existing customers. In addition, requests to move, add, change, or renew existing service arrangements will not be accepted. Following the expiration of a customer's existing term agreement, service will be provided on a month-to-month basis at the applicable Monthly rates until the service is discontinued. The Company currently plans to discontinue this service on or after March 31, 2023.

(N)

(N)

E7. SPECIAL ACCESS (A.K.A. BELL SOUTH SPA) SERVICE

E7.4 Rate Regulations (Cont'd)

E7.4.32 BellSouth Metro Ethernet Service (Cont'd)²

(C)

B. Rate Categories and Regulations (Cont'd)

8. A Premium BellSouth Metro Ethernet Connection-Fixed Mode and Premium BellSouth Metro Ethernet Connection-Burst Mode of the same speed are considered to be the same order of service and same physical service type. A Service Reconfiguration Charge is applicable for a customer request to reconfigure a Premium BellSouth Metro Ethernet Connection from Fixed Mode to Burst Mode (at the same speed), or vice versa; this nonrecurring charge is in lieu of the nonrecurring charge for the new connection. Such a change is not treated as a disconnect and there will be no change in the minimum period requirements.

A Virtual BellSouth Metro Ethernet Connection request to modify its CoS Profile is not considered as a request to change the order of service or physical service type. A Service Reconfiguration Charge is applicable for such requests.

9. Except as specified in 8. preceding, a BellSouth Metro Ethernet Connection not shown as a higher order of service in the hierarchy chart in 5. preceding for a given BellSouth Metro Ethernet Connection is considered to be a lower order of service. A reconfiguration charge is applicable for a customer request to change an existing BellSouth Metro Ethernet Connection to a different BellSouth Metro Ethernet Connection that is a lower order of service; the appropriate reconfiguration charge is applicable in lieu of the standard nonrecurring charge for the lower order of service connection. A Service Reconfiguration Charge is applicable when the lower order of service connection is the same physical service type; a System Reconfiguration Charge is applicable when the lower order of service is a different physical service type. New minimum period requirements are established for the lower order of service connection.
10. A System Reconfiguration Charge is applicable for a customer request to change the premises powering option (AC power to DC power) or NCTE signaling interface option (optical to electrical, or vice-versa) on an existing BellSouth Metro Ethernet Connection. Such a change is not treated as a disconnect and there will be no change in the minimum period requirements.
11. A move of a BellSouth Metro Ethernet service will be as follows (in accordance with E7.4.5 preceding and, if applicable, E2.4.9.C.5. of this Tariff).
- When the move is to a new location within the same building, the charge for the move will be an amount equal to one-half of the Connection nonrecurring charge. There will be no change in the minimum period requirements.
- When the move is to a new location in a different building that is within the same serving wire center, the charge for the move will be the nonrecurring charge for the BellSouth Metro Ethernet service Connection. New minimum period requirements will be established.¹
- When the move is to a new location in a different building that is not in the same serving wire center, the request is treated as a discontinuance and start of service and all associated BellSouth Metro Ethernet service nonrecurring charges will apply. New minimum period requirements will be established.¹

Note 1: Such moves of Metro Ethernet Service with Automatic Protection Switching (APS) shall additionally incur the full nonrecurring charge for establishing the APS feature at the new premises (as a new APS design will be required). The APS monthly recurring charge may change as appropriate based upon the actual route mileage associated with the new premises' APS design.

Note 2: Effective on or after August 22, 2021, this Service will no longer be available for purchase by new or existing customers. In addition, requests to move, add, change, or renew existing service arrangements will not be accepted. Following the expiration of a customer's existing term agreement, service will be provided on a month-to-month basis at the applicable Monthly rates until the service is discontinued. The Company currently plans to discontinue this service on or after March 31, 2023.

(N)

(N)

E7. SPECIAL ACCESS (A.K.A. BELLSOUTH SPA) SERVICE

E7.4 Rate Regulations (Cont'd)

E7.4.32 BellSouth Metro Ethernet Service (Cont'd)²

(C)

C. Service Level Agreement for Premium BellSouth Metro Ethernet service

Customer networks with Premium BellSouth Metro Ethernet service and *CNM* - Metro Ethernet Reporting are provided Service Level Agreements (SLAs) as summarized herein E7.4.32.C. BellSouth Metro Ethernet Service SLAs outlined herein specify the Company's repair and performance commitments for *CNM* - Metro Ethernet Reporting customers with Premium Metro Ethernet Connections. Details of the technical measurements and performance results methodologies for each commitment are provided in BellSouth Technical Reference TR-73632.

In accordance with E7.4.32.C.3.(c) following, credits are available for missed commitments to customers purchasing Premium BellSouth Metro Ethernet service with the *CNM* - Metro Ethernet Reporting feature. Credits only apply for portions of service provided by the Company.

The following service measurements will outline the service levels the Telephone Company will deliver to *CNM* - Metro Ethernet Reporting customers with Premium Metro Ethernet Connections:

Repair Commitment:

- BellSouth Metro Ethernet service Time-to-Repair¹

Network Service Level Commitments:

- BellSouth Metro Ethernet service Core Network Availability
- BellSouth Metro Ethernet service Core Network Latency

The Repair Commitment is measured on a per occurrence basis for each BellSouth Metro Ethernet Connection. A Fault Report is produced thru the *CNM* - Metro Ethernet Reporting system that aids identification of potential outage durations upon which credits may be requested.

The Network Service Level Commitments are measured on the monthly performance of the Metro Ethernet core network during a specific calendar month. An SLA Report is produced thru the Metro Ethernet Reporting system that provides details of missed Network Service Level Commitments upon which credits may be requested based upon a specific calendar month's performance results.

The Company's performance measurement data for the Repair Commitment and Network Service Level Commitments will be collected and calculated utilizing the Company's internal processes as set forth in BellSouth Technical Reference TR-73632. The Company's calculation of its performance shall be the sole determinate of the Company's obligation to provide a credit for a missed performance commitment.

1. SLA Definitions

BellSouth Metro Ethernet service Time to Repair

- BellSouth Metro Ethernet service Time-To-Repair measures the outage duration on a customer's BellSouth Metro Ethernet Connection. This measure will require the customer to report the problem to the BellSouth repair center.
- The repair interval will start with the time the trouble ticket is created and end when the fault is re-mediated. The Service Level Commitment measurement will be based on each individual trouble ticket for a customer's connection. Time for scheduled maintenance windows (as set forth in E7.4.32.A.3. preceding) does not count towards SLA threshold.

BellSouth Metro Ethernet service Network Availability

- BellSouth Metro Ethernet service Network Availability measures the percentage of time during a calendar month that the customer's service is unavailable on the core network. The core network is defined as being from the Ethernet switch serving the customer's A-end to the Ethernet switch serving the customer's B-end. Customer networks that do not span more than one switch in the core network are not eligible for the Network Availability SLA, and one will not be provided.
- This Service Level Commitment will be calculated by measuring and summing the outage for each core network component used by the customer, divided by the total number of components, times the total service time for a particular calendar month. Excluded from the outage time and service time are scheduled maintenance windows (as set forth in E7.4.32.A.3. preceding) and time the network was unavailable due to circumstances outside the Company's control (as set forth in E7.4.32.C.3.(b) following).

Note 1: SLA not applicable if missed due to SMARTRing service (a.k.a BellSouth SPA Dedicated Ring) outage where BellSouth Metro Ethernet is using SMARTRing service (a.k.a BellSouth SPA Dedicated Ring) as alternate transport.

Note 2: Effective on or after August 22, 2021, this Service will no longer be available for purchase by new or existing customers. In addition, requests to move, add, change, or renew existing service arrangements will not be accepted. Following the expiration of a customer's existing term agreement, service will be provided on a month-to-month basis at the applicable Monthly rates until the service is discontinued. The Company currently plans to discontinue this service on or after March 31, 2023.

(N)
|
(N)

E7. SPECIAL ACCESS (A.K.A. BELLSOUTH SPA) SERVICE

E7.4 Rate Regulations (Cont'd)

E7.4.32 BellSouth Metro Ethernet Service (Cont'd)²

(C)

C. Service Level Agreement for Premium BellSouth Metro Ethernet service¹ (Cont'd)

1. SLA Definitions (Cont'd)

BellSouth Metro Ethernet service Network Latency

- BellSouth Metro Ethernet service Network Latency measures average one-way delay in milliseconds within the core network. The core network is defined as being from the Ethernet switch serving the customer's A-end to the Ethernet switch serving the customer's B-end. Customer networks that do not span more than one switch in the core network are not eligible for the Network Latency SLA, and one will not be provided.
- This Service Level Commitment will be calculated by averaging the measured latency of simulated traffic within the Metro Ethernet Customer Network (i.e., between each pair of connections) during a calendar month.

2. The Company's Service Level Commitments for Premium BellSouth Metro Ethernet service are as follows:

- BellSouth Metro Ethernet service Time-To-Repair – 4 hours or less
- BellSouth Metro Ethernet service Network Availability – 99.9% or higher
- BellSouth Metro Ethernet service Network Latency – 55 milliseconds or less

3. SLA Restrictions

- (a) The Company will implement SLA provisioning restrictions that will define customer network design requirements and limitations to BellSouth's commitment to meet Service Levels for BellSouth Metro Ethernet service. The customer network design requirements are as follows:
 - A customer must subscribe to the Metro Ethernet Premium Service with *CNM* - Metro Ethernet Reporting to receive credits for missed Service Level Commitments.
 - Credits are not provided for partial month service.
 - A customer's account must be current to receive a credit.
- (b) SLA Credits do not apply when any stated objective is not met because the Company does not have control over the circumstances causing the objective to be missed. Situations over which the Company does not have control include, but are not limited to, the following:
 - any act, any omission or negligence on the part of the customer, any other customer or any third party, or of any other entity providing a portion of the service,
 - labor difficulties, governmental orders, civil commotions, acts of civil or military authority, embargoes, epidemics, declared National Emergencies, criminal actions against the Company, war, terrorist acts, riots, insurrections, fires, explosions, nuclear accidents, power blackouts, acts of God (including, but not limited to, earthquakes, floods or unusually severe weather) or other circumstances beyond the Company's control,
 - the customer's premises equipment, and
 - unavailability of the customer's facilities and/or equipment including customer-provided power and environmental conditions for BellSouth-owned and operated equipment located on the customer's premises.
- (c) The Customer must request a credit within one month of the Company missing a BellSouth Metro Ethernet service Level Commitment. A customer request for a Network Service Level SLA credit must be submitted on a standard request form issued by the Company that includes the month the SLA commitment was missed, accurate identification of the affected circuit, and the observed measurement of the specific SLA that was missed. A customer request for a Repair SLA credit must be submitted on a standard request form issued by the Company that includes the month the SLA commitment was missed, accurate identification of the affected circuit, and the trouble ticket number of the repair request. The Company will investigate customer requests for any SLA credits to determine the cause of any performance failures reported by the customer. The Company will investigate the customer's request over a period of up to 45 calendar days. The 45-day period will begin when the customer makes the request for credit with their BellSouth Sales Representative. SLA credits will be provided to the customer if the Company determines that the Company had control over the circumstances causing the failure.

Note 1: Details of the technical measurements and performance results methodologies for each Commitment are provided in BellSouth Technical Reference TR-73632.

Note 2: Effective on or after August 22, 2021, this Service will no longer be available for purchase by new or existing customers. In addition, requests to move, add, change, or renew existing service arrangements will not be accepted. Following the expiration of a customer's existing term agreement, service will be provided on a month-to-month basis at the applicable Monthly rates until the service is discontinued. The Company currently plans to discontinue this service on or after March 31, 2023.

(N)

(N)

E7. SPECIAL ACCESS (A.K.A. BELL SOUTH SPA) SERVICE

E7.4 Rate Regulations (Cont'd)

E7.4.32 BellSouth Metro Ethernet Service (Cont'd)⁴

(C)

C. Service Level Agreement for Premium BellSouth Metro Ethernet service¹ (Cont'd)

4. SLA Credits for Premium Connections with *CNM* - Metro Ethernet Reporting

The following credits will apply when the Company misses a Service Level Commitment (each credit is described in (a) thru (c) following):

BellSouth Metro Ethernet service Time-To-Repair:

- 0 to 4 hours per incident: No Credit
- Over 4 hours to 24 hours per incident: A credit equal to 3/30 of the monthly recurring charges for all the rate elements² associated with the affected Metro Ethernet Connection
- Each additional 24-hour period, per incident: Credit an additional amount equal to 3/30 of the monthly recurring charges for all the rate elements² associated with the affected Metro Ethernet Connection

BellSouth Metro Ethernet service Network Availability:

- A credit equal to 3/30 of the monthly recurring charges for all the rate elements² associated with the affected Metro Ethernet Connection.

BellSouth Metro Ethernet service Network Latency:

- A credit equal to 3/30 of the monthly recurring charges for all the rate elements² associated with the affected Metro Ethernet Connection.

The SLA credit amount will be determined by applying the credits outlined preceding to the rate elements or total billed revenues specified following.

The total credits issued for all SLAs for a specific BellSouth Metro Ethernet service Connection during a single bill period may not exceed the total monthly recurring charges billed for all the rate elements associated with that BellSouth Metro Ethernet service Connection. Credits are not provided for partial month service.

- (a) BellSouth Metro Ethernet service Time-To-Repair Credit – The Service Level Commitment measurement will be based on each individual trouble ticket for a customer's connection. Multiple trouble tickets on the same day for the same customer connection will only be eligible for one time-to-repair credit. The SLA credit will apply to the monthly recurring charges for all the rate elements² associated with the affected Metro Ethernet Connection.
- (b) BellSouth Metro Ethernet service Network Availability Credit³ – The Service Level commitment measurement will be based on a specific calendar month's performance. The credit will apply for each BellSouth Metro Ethernet service connection that does not meet the availability commitment. The SLA credit will apply to the monthly recurring charges for all the rate elements² associated with the affected Metro Ethernet Connection.
- (c) BellSouth Metro Ethernet service Latency Credit³ – The Service Level commitment measurement will be based on a specific calendar month's performance. The credit will apply for each BellSouth Metro Ethernet service connection that does not meet the latency commitment. The SLA credit will apply to the monthly recurring charges for all the rate elements² associated with the affected Metro Ethernet Connection.

Note 1: Details of the technical measurements and performance results methodologies for each Commitment are provided in BellSouth Technical Reference TR-73632.

Note 2: Specifically, rate elements for the Metro Ethernet Connection, Additional Mileage and Features.

Note 3: BellSouth Metro Ethernet networks that do not span more than one switch in the core network are not eligible for credits under this SLA.

Note 4: Effective on or after August 22, 2021, this Service will no longer be available for purchase by new or existing customers. In addition, requests to move, add, change, or renew existing service arrangements will not be accepted. Following the expiration of a customer's existing term agreement, service will be provided on a month-to-month basis at the applicable Monthly rates until the service is discontinued. The Company currently plans to discontinue this service on or after March 31, 2023.

(N)
|
(N)

E7. SPECIAL ACCESS (A.K.A. BELLSOUTH SPA) SERVICE

E7.4 Rate Regulations (Cont'd)

E7.4.32 BellSouth Metro Ethernet Service (Cont'd)⁴

(C)

D. Service Level Agreement for Virtual BellSouth Metro Ethernet service

Customer networks with Virtual BellSouth Metro Ethernet Service and *CNM* - Metro Ethernet Reporting are provided Service Level Agreements (SLAs) as summarized herein E7.4.32.D. BellSouth Metro Ethernet Service SLAs outlined herein specify the Telephone Company's repair and performance commitments for *CNM* - Metro Ethernet Reporting customers with Virtual Metro Ethernet Connections. SLAs will be applied on a per Class of Service (CoS) basis for Virtual Connections; traffic representing the different CoS (i.e., Best Effort, Business Critical, Real-Time and Interactive) transported across the same Virtual Connection will have different SLAs. Details of the technical measurements and performance results methodologies for each commitment are provided in BellSouth Technical Reference TR-73632.

In accordance with E7.4.32.D.3.(c) following, credits are available for missed commitments to customers purchasing Virtual BellSouth Metro Ethernet Service with the *CNM* - Metro Ethernet Reporting feature. Credits only apply for portions of service provided by the Telephone Company.

The following service measurements will outline the service levels the Telephone Company will deliver to *CNM* - Metro Ethernet Reporting customers with Virtual Metro Ethernet Connections:

Repair Commitment:

- BellSouth Metro Ethernet service Time-to-Repair¹

Network Service Level Commitments:

- BellSouth Metro Ethernet service Core Network Availability
- BellSouth Metro Ethernet service Core Network Latency²
- BellSouth Metro Ethernet service Core Network Jitter^{2,3}
- BellSouth Metro Ethernet service Core Network Packet Delivery²

The Repair Commitment is measured on a per occurrence basis for each BellSouth Metro Ethernet Connection for all CoS. A Fault Report is produced thru the *CNM* - Metro Ethernet Reporting system that aids identification of potential outage durations upon which credits may be requested.

The Network Service Level Commitments are measured on the monthly performance of the Metro Ethernet core network during a specific calendar month by CoS. An SLA Report is produced thru the *CNM* - Metro Ethernet Reporting system that provides details of missed Network Service Level Commitments by CoS upon which credits may be requested based upon a specific calendar month's performance results.

The Company's performance measurement data for the Repair Commitment and Network Service Level Commitments will be collected and calculated utilizing the Company's internal processes as set forth in BellSouth Technical Reference TR-73632. The Company's calculation of its performance shall be the sole determinate of the Company's obligation to provide a credit for a missed performance commitment.

Note 1: SLA not applicable if missed due to SMARTRing service (a.k.a BellSouth SPA Dedicated Ring) outage where BellSouth Metro Ethernet is using SMARTRing service (a.k.a BellSouth SPA Dedicated Ring) as alternate transport.

Note 2: SLA not applicable for Best Effort CoS.

Note 3: SLA not applicable for Business Critical CoS.

Note 4: Effective on or after August 22, 2021, this Service will no longer be available for purchase by new or existing customers. In addition, requests to move, add, change, or renew existing service arrangements will not be accepted. Following the expiration of a customer's existing term agreement, service will be provided on a month-to-month basis at the applicable Monthly rates until the service is discontinued. The Company currently plans to discontinue this service on or after March 31, 2023.

(N)

(N)

E7. SPECIAL ACCESS (A.K.A. BELL SOUTH SPA) SERVICE

E7.4 Rate Regulations (Cont'd)

E7.4.32 BellSouth Metro Ethernet Service (Cont'd)²

(C)

D. Service Level Agreement for Virtual BellSouth Metro Ethernet service¹ (Cont'd)

1. SLA Definitions

BellSouth Metro Ethernet service Time to Repair

- BellSouth Metro Ethernet Service Time-To-Repair measures the outage duration on a customer's BellSouth Metro Ethernet Connection for all CoS. This measure will require the customer to report the problem to the BellSouth repair center.
- The repair interval will start with the time the trouble ticket is created and end when the fault is re-mediated. The Service Level Commitment measurement will be based on each individual trouble ticket for a customer's connection. Time for scheduled maintenance windows (as set forth in E7.4.32.A.3.) does not count towards SLA threshold.

BellSouth Metro Ethernet service Network Availability

- BellSouth Metro Ethernet Service Network Availability measures the percentage of time by CoS during a calendar month that the customer's service is unavailable on the core network. The core network is defined as being from the Ethernet switch serving the customer's A-end to the Ethernet switch serving the customer's B-end. Customer networks that do not span more than one switch in the core network are not eligible for the Network Availability SLA, and one will not be provided.
- This Service Level Commitment will be calculated by CoS by measuring and summing the outage for each core network component used by the customer, divided by the total number of components, times the total service time for a particular calendar month. Excluded from the outage time and service time are scheduled maintenance windows (as set forth in E7.4.32.A.3.) and time the network was unavailable due to circumstances outside the Telephone Company's control (as set forth in E7.4.32.D.3.(b)).

BellSouth Metro Ethernet service Network Latency

- BellSouth Metro Ethernet Service Network Latency measures average one-way delay in milliseconds within the core network. The core network is defined as being from the Ethernet switch serving the customer's A-end to the Ethernet switch serving the customer's B-end. Customer networks that do not span more than one switch in the core network are not eligible for the Network Latency SLA, and one will not be provided.
- This Service Level Commitment will be calculated for each CoS (except the Best Effort CoS) by averaging the measured latency of simulated traffic for each eligible CoS within the Metro Ethernet Customer Network (i.e., between each pair of connections) during a calendar month.

BellSouth Metro Ethernet service Network Jitter

- BellSouth Metro Ethernet Service Jitter measures the average variability, measured in time (milliseconds) between the actual packet transmission rate and the expected packet transmission rate within the core network for Interactive and Real-Time CoS. The core network is defined as being from the Ethernet switch serving the customer's A-end to the Ethernet switch serving the customer's B-end.
- This Service Level Commitment will be calculated for the Interactive CoS and Real-Time CoS by averaging the measured jitter of simulated traffic for each of the customer's eligible CoS queue within the Metro Ethernet Customer Network (i.e., between each pair of connections) during a calendar month.

BellSouth Metro Ethernet service Packet Delivery

- BellSouth Metro Ethernet Service Network Packet Delivery measures the percentage of packets conforming to the committed bandwidth profile that are delivered across the core network, without being dropped or lost as a result of a fault within the Virtual Ethernet network. The core network is defined as being from the Ethernet switch serving the customer's A-end to the Ethernet switch serving the customer's B-end.
- This Service Level Commitment will be calculated for each CoS (except the Best Effort CoS) by averaging the measured packet delivery of simulated traffic for eligible CoS within the Metro Ethernet Customer Network (i.e., between each pair of connections) during a calendar month.

Note 1: Details of the technical measurements and performance results methodologies for each commitment are provided in BellSouth Technical Reference TR-73632.

Note 2: Effective on or after August 22, 2021, this Service will no longer be available for purchase by new or existing customers. In addition, requests to move, add, change, or renew existing service arrangements will not be accepted. Following the expiration of a customer's existing term agreement, service will be provided on a month-to-month basis at the applicable Monthly rates until the service is discontinued. The Company currently plans to discontinue this service on or after March 31, 2023.

(N)

(N)

E7. SPECIAL ACCESS (A.K.A. BELLSOUTH SPA) SERVICE

E7.4 Rate Regulations (Cont'd)

E7.4.32 BellSouth Metro Ethernet Service (Cont'd)²

(C)

D. Service Level Agreement for Virtual BellSouth Metro Ethernet service¹ (Cont'd)

2. The Telephone Company's Service Level Commitments for Virtual BellSouth Metro Ethernet service are as follows:

Time to Repair

- Best Effort CoS: 4 hours or less
- Business Critical CoS: 4 hours or less
- Interactive CoS: 4 hours or less
- Real-Time CoS: 4 hours or less

Network Availability

- Best Effort CoS: 99.500% or greater
- Business Critical CoS: 99.995% or greater
- Interactive CoS: 99.995% or greater
- Real-Time CoS: 99.995% or greater

Latency (one-way)

- Best Effort CoS: Not Applicable
- Business Critical CoS: 15 milliseconds or less
- Interactive CoS: 5 milliseconds or less
- Real-Time CoS: 5 milliseconds or less

Jitter

- Best Effort CoS: Not Applicable
- Business Critical CoS: Not Applicable
- Interactive CoS: 1 millisecond or less
- Real-Time CoS: 1 millisecond or less

Packet Delivery

- Best Effort CoS: Not Applicable
- Business Critical CoS: 99.900% or greater
- Interactive CoS: 99.950% or greater
- Real-Time CoS: 99.995% or greater

Note 1: Details of the technical measurements and performance results methodologies for each commitment are provided in BellSouth Technical Reference TR-73632.

Note 2: Effective on or after August 22, 2021, this Service will no longer be available for purchase by new or existing customers. In addition, requests to move, add, change, or renew existing service arrangements will not be accepted. Following the expiration of a customer's existing term agreement, service will be provided on a month-to-month basis at the applicable Monthly rates until the service is discontinued. The Company currently plans to discontinue this service on or after March 31, 2023.

(N)
|
(N)

E7. SPECIAL ACCESS (A.K.A. BELLSOUTH SPA) SERVICE

E7.4 Rate Regulations (Cont'd)

E7.4.32 BellSouth Metro Ethernet Service (Cont'd)²

(C)

D. Service Level Agreement for Virtual BellSouth Metro Ethernet service¹ (Cont'd)

3. SLA Restrictions

- (a) The Telephone Company will implement SLA provisioning restrictions that will define customer network design requirements and limitations to BellSouth's commitment to meet Service Levels for BellSouth Metro Ethernet Service. The customer network design requirements are as follows:
- A customer must subscribe to the Metro Ethernet Virtual Service with *CNM* - Metro Ethernet Reporting to receive credits for missed Service Level Commitments.
 - Credits are not provided for partial month service.
 - A customer's account must be current to receive a credit.
- (b) SLA Credits do not apply when any stated objective is not met because the Telephone Company does not have control over the circumstances causing the objective to be missed. Situations over which the Telephone Company does not have control include, but are not limited to, the following:
- any act, any omission or negligence on the part of the customer, any other customer or any third party, or of any other entity providing a portion of the service,
 - labor difficulties, governmental orders, civil commotions, acts of civil or military authority, embargoes, epidemics, declared National Emergencies, criminal actions against the Telephone Company, war, terrorist acts, riots, insurrections, fires, explosions, nuclear accidents, power blackouts, acts of God (including, but not limited to, earthquakes, floods or unusually severe weather) or other circumstances beyond the Telephone Company's control,
 - the customer's premises equipment, and
 - unavailability of the customer's facilities and/or equipment including customer-provided power and environmental conditions for BellSouth-owned and operated equipment located on the customer's premises.
- (c) The Customer must request a credit within one month of the Telephone Company missing a BellSouth Metro Ethernet Service Level Commitment. A customer request for a Network Service Level SLA credit must be submitted on a standard request form issued by the Company that includes the month the SLA commitment was missed, accurate identification of the affected circuit, and the observed measurement of the specific SLA that was missed. A customer request for a Repair SLA credit must be submitted on a standard request form issued by the Company that includes the month the SLA commitment was missed, accurate identification of the affected circuit, and the trouble ticket number of the repair request. The Telephone Company will investigate customer requests for any SLA credits to determine the cause of any performance failures reported by the customer. The Telephone Company will investigate the customer's request over a period of up to 45 calendar days. The 45-day period will begin when the customer makes the request for credit with their BellSouth Sales Representative. SLA credits will be provided to the customer if the Company determines that the Telephone Company had control over the circumstances causing the failure.

Note 1: Details of the technical measurements and performance results methodologies for each commitment are provided in BellSouth Technical Reference TR-73632.

Note 2: Effective on or after August 22, 2021, this Service will no longer be available for purchase by new or existing customers. In addition, requests to move, add, change, or renew existing service arrangements will not be accepted. Following the expiration of a customer's existing term agreement, service will be provided on a month-to-month basis at the applicable Monthly rates until the service is discontinued. The Company currently plans to discontinue this service on or after March 31, 2023.

(N)

(N)

E7. SPECIAL ACCESS (A.K.A. BELLSOUTH SPA) SERVICE

E7.4 Rate Regulations (Cont'd)

E7.4.32 BellSouth Metro Ethernet Service (Cont'd)³

(C)

D. Service Level Agreement for Virtual BellSouth Metro Ethernet service¹ (Cont'd)

4. SLA Credits for Virtual Connections with *CNM* - Metro Ethernet Reporting (Cont'd)

The following credits will apply when the Telephone Company misses a Service Level Commitment on any single CoS (each credit is described in (a) thru (e) following). A maximum of one credit will be applied monthly per Connection for an SLA not met for any CoS that is supported by the customer's CoS profile (i.e., a maximum of one credit is applicable for an SLA even if missed for multiple CoS).

BellSouth Metro Ethernet service Time-To-Repair:

- 0 to 4 hours per incident: No Credit
- Over 4 hours to 24 hours per incident: A credit equal to 3/30 of the monthly recurring charges for all the rate elements² associated with the affected Metro Ethernet Connection
- Each additional 24-hour period, per incident: Credit an additional amount equal to 3/30 of the monthly recurring charges for all the rate elements² associated with the affected Metro Ethernet Connection

BellSouth Metro Ethernet service Network Availability: A credit equal to 3/30 of the monthly recurring charges for all the rate elements² associated with the affected Metro Ethernet Connection

BellSouth Metro Ethernet service Latency: A credit equal to 3/30 of the monthly recurring charges for all the rate elements² associated with the affected Metro Ethernet Connection.

BellSouth Metro Ethernet service Jitter: A credit equal to 3/30 of the monthly recurring charges for all the rate elements² associated with the affected Metro Ethernet Connection.

BellSouth Metro Ethernet service Packet Delivery: A credit equal to 3/30 of the monthly recurring charges for all the rate elements² associated with the affected Metro Ethernet Connection.

Note 1: Details of the technical measurements and performance results methodologies for each commitment are provided in BellSouth Technical Reference TR-73632.

Note 2: Specifically, rate elements for the Metro Ethernet Connection, Additional Mileage and Features.

Note 3: Effective on or after August 22, 2021, this Service will no longer be available for purchase by new or existing customers. In addition, requests to move, add, change, or renew existing service arrangements will not be accepted. Following the expiration of a customer's existing term agreement, service will be provided on a month-to-month basis at the applicable Monthly rates until the service is discontinued. The Company currently plans to discontinue this service on or after March 31, 2023.

(N)
|
(N)

E7. SPECIAL ACCESS (A.K.A. BELLSOUTH SPA) SERVICE

E7.4 Rate Regulations (Cont'd)

E7.4.32 BellSouth Metro Ethernet Service (Cont'd)⁴

(C)

D. Service Level Agreement for Virtual BellSouth Metro Ethernet service¹ (Cont'd)

4. SLA Credits for Virtual Connections with *CNM* - Metro Ethernet Reporting (Cont'd)

The SLA credit amount will be determined by applying the credits outlined preceding to the rate elements or total billed revenues specified following:

The total credits issued for all SLAs for a specific BellSouth Metro Ethernet service Connection during a single bill period may not exceed the total monthly recurring charges billed for all the rate elements associated with that BellSouth Metro Ethernet service Connection. Credits are not provided for partial month service.

- (a) BellSouth Metro Ethernet Service Time-To-Repair Credit – The Service Level Commitment measurement will be based on each individual trouble ticket for a customer's connection. Multiple trouble tickets on the same day for the same customer connection will only be eligible for one time-to-repair credit. The SLA credit will apply to the monthly recurring charges for all the rate elements² associated with the affected Metro Ethernet Connection
- (b) BellSouth Metro Ethernet Service Network Availability Credit³ – The Service Level Commitment measurement will be based on a specific calendar month's performance. The credit will apply for each BellSouth Metro Ethernet Service Connection that does not meet the availability commitment. The SLA credit will apply to the monthly recurring charges for all the rate elements² associated with the affected Metro Ethernet Connection.
- (c) BellSouth Metro Ethernet Service Latency Credit³ – The Service Level Commitment measurement will be based on a specific calendar month's performance. The credit will apply for each BellSouth Metro Ethernet Service Connection that does not meet the latency Commitment for any eligible CoS. The SLA credit will apply to the monthly recurring charges for all the rate elements² associated with the affected Metro Ethernet Connection.
- (d) BellSouth Metro Ethernet Service Jitter Credit³ – The Service Level Commitment measurement will be based on a specific calendar month's performance. The credit will apply for each BellSouth Metro Ethernet Service Connection that does not meet the jitter Commitment for any eligible CoS. The SLA credit will apply to the monthly recurring charges for all the rate elements² associated with the affected Metro Ethernet Connection.
- (e) BellSouth Metro Ethernet Service Packet Delivery Credit³ – The Service Level Commitment measurement will be based on a specific calendar month's performance. The credit will apply for each BellSouth Metro Ethernet Service Connection that does not meet the packet delivery commitment for any eligible CoS. The SLA credit will apply to the monthly recurring charges for all the rate elements² associated with the affected Metro Ethernet Connection.

Note 1: Details of the technical measurements and performance results methodologies for each commitment are provided in BellSouth Technical Reference TR-73632.

Note 2: Specifically, rate elements for the Metro Ethernet Connection, Additional Mileage and Features.

Note 3: BellSouth Metro Ethernet networks that do not span more than one switch in the core network are not eligible for credits under this SLA.

Note 4: Effective on or after August 22, 2021, this Service will no longer be available for purchase by new or existing customers. In addition, requests to move, add, change, or renew existing service arrangements will not be accepted. Following the expiration of a customer's existing term agreement, service will be provided on a month-to-month basis at the applicable Monthly rates until the service is discontinued. The Company currently plans to discontinue this service on or after March 31, 2023.

(N)
|
(N)

E7. SPECIAL ACCESS (A.K.A. BELLSOUTH SPA) SERVICE

E7.5 Rates and Charges

(M)

E7.5.1 Reserved for Future Use

(M)

E7.5.2 Reserved for Future Use

(M)

E7.5.3 Reserved for Future Use

(M)

E7.5.4 Reserved for Future Use

(M)

E7.5.5 Reserved for Future Use

(M)

E7.5.6 Reserved for Future Use

(M)

Material appearing on this page previously appeared on page(s) 42.8 of this section.

All BellSouth marks contained herein and as set forth in the trademarks and service marks section of the BellSouth Tariffs are owned by BellSouth Intellectual Property Corporation.

E7. SPECIAL ACCESS (A.KA. BELLSOUTH SPA) SERVICE

E7.5 Rates and Charges (Cont'd)

E7.5.7 Voice Grade¹ (a.k.a. BellSouth SPA DS0 VG) Service

(C)

A. Local Channel

1. Per Point of Termination

a. Voice Grade (a.k.a. BellSouth SPA DS0 VG)

(1) Voice

		Nonrecurring Charge		
	Monthly Rate	First Service Installed	Additional Service Installed	USOC
(a) Two-Wire	\$30.00	\$255.46	\$125.00	T6E2X
(b) Four-Wire	44.00	260.00	135.00	T6E4X
(2) Data				
(a) Two-Wire	30.00	235.00	130.00	T6E2X
(b) Four-Wire	44.00	260.00	140.00	T6E4X

B. Interoffice Channel

1. Miles

	Fixed Monthly Charge	Monthly Charge Per Mile	Nonrecurring Charge	USOC
(a) 0	\$ -	\$ -	\$ -	NA
(b) 1 and above	13.00(I)	2.24	78.40	1L5XX

Note 1: Effective June 30, 2021, this Service will no longer be available for purchase by new or existing customers. In addition, requests to move, add, change, or renew existing service arrangements will not be accepted. Following the expiration of a customer's existing term agreement, service will be provided on a month-to-month basis at the applicable Monthly rates until the service is discontinued. The Company currently plans to discontinue this service on or after June 30, 2024.

(N)

(N)

E7. SPECIAL ACCESS (A.K.A. BELLSOUTH SPA) SERVICE

E7.5 Rates and Charges (Cont'd)

E7.5.7 Voice Grade¹ (a.k.a. BellSouth SPA DS0 VG) Service (Cont'd)

(C)

B. (Cont'd)

1. (Cont'd)

(e) **(DELETED)**

C. Optional Features and Functions

1. Bridging

a. Voice Bridging, Two-Wire/Four-Wire

(1) Per port

- (a) Two-Wire
- (b) Four-Wire

b. Data Bridging, Two-Wire/Four-Wire

(1) Per port

- (a) **(DELETED)**
- (b) Four-Wire

c. Telephoto Bridging, Two-Wire/Four-Wire

(1) Per port

- (a) Two-Wire
- (b) Four-Wire

d. **(DELETED)**

e. **(DELETED)**

f. **(DELETED)**

g. **(DELETED)**

	Monthly Rate	Nonrecurring Charge	USOC
(a) Two-Wire	\$4.96	\$31.85	BCNV2
(b) Four-Wire	4.96	39.70	BCNV4
(b) Four-Wire	8.25	43.00	BCND4
(a) Two-Wire	4.96	31.85	BCNF2
(b) Four-Wire	4.96	39.70	BCNF4

Note 1: Effective June 30, 2021, this Service will no longer be available for purchase by new or existing customers. In addition, requests to move, add, change, or renew existing service arrangements will not be accepted. Following the expiration of a customer's existing term agreement, service will be provided on a month-to-month basis at the applicable Monthly rates until the service is discontinued. The Company currently plans to discontinue this service on or after June 30, 2024.

(N)
|
(N)

E7. SPECIAL ACCESS (A.K.A. BELLSOUTH SPA) SERVICE

E7.5 Rates and Charges (Cont'd)

E7.5.7 Voice Grade⁵ (a.k.a. BellSouth SPA DS0 VG) Service (Cont'd)

(C)

- C. Optional Features and Functions (Cont'd)
 - 2. Conditioning, Per Point of Termination

	Monthly	Nonrecurring Charge		
	Rate	Initial	Subsequent	USOC
(a) C-Type	\$1.17	\$10.00	\$95.50	X1CPT
(b) Improved Attenuation Distortion	50.00	10.00	110.00	UHW
(c) Improved Envelope Delay Distortion	50.00	40.00	130.00	UHY
(d) Sealing Current	-	-	-	1HBPT
3. Echo Control for Effective Two-Wire Service Per Point of Termination				
(a) Improved Return Loss At the Two-Wire Point of Termination	15.00	25.00	125.00	1RL2W
(b) ELEPL2 At the Four-Wire Point of Termination	15.00	25.00	42.00	UHZ
4. Customer Specified Receive Level				
(a) Per two-wire Point of Termination	18.00	2.40	83.49	RLS
5. D-Conditioning				
(a) Per Point of Termination	4.75	2.40	120.00	XDCPT
6. Telephoto Capability				
(a) Per Point of Termination	1.87	2.40	115.00	XTCPT
7. Signaling Capability, per Point of Termination				
(a) Loop ¹	20.00	2.40	110.00	XSS++
(b) Single Frequency	20.00	2.40	115.00	XSSSF
(c) E&M ²	20.00	2.40	120.00	XSS++
(d) Ground ³	20.00	2.40	110.00	XSS++
(e) Other ⁴	20.00	2.40	115.00	XSS++

Note 1: In lieu of ++ substitute LO and LS as appropriate.

Note 2: In lieu of ++ substitute EA, EB, EC and CT as appropriate.

Note 3: In lieu of ++ substitute GO or GS as appropriate.

Note 4: In lieu of ++ substitute LA, LB, LC, LR, RV, DX, DY, EX, AB or AC as appropriate.

Note 5: Effective June 30, 2021, this Service will no longer be available for purchase by new or existing customers. In addition, requests to move, add, change, or renew existing service arrangements will not be accepted. Following the expiration of a customer's existing term agreement, service will be provided on a month-to-month basis at the applicable Monthly rates until the service is discontinued. The Company currently plans to discontinue this service on or after June 30, 2024.

(N)

(N)

E7. SPECIAL ACCESS (A.K.A. BELLSOUTH SPA) SERVICE

E7.5 Rates and Charges (Cont'd)

E7.5.7 Voice Grade⁴ (a.k.a. BellSouth SPA DS0 VG) Service (Cont'd)

(C)

C. Optional Features and Functions (Cont'd)

8. Improved Termination

	Monthly Rate	Nonrecurring Charge		USOC
		Initial	Subsequent	UGD
(a) Per Point of Termination	\$6.50	-	115.00	UGD

D. WATS Access Line⁴ (a.k.a. BellSouth SPA WATS Line)

(C)

The following apply to a WATS Access Line (a.k.a. BellSouth SPA WATS Line) used for interLATA only calling. Rates for all other WATS Access Lines (a.k.a. BellSouth SPA WATS Line) (i.e., combined interLATA/intraLATA calling) can be found in *North Carolina's Non-Regulated Services – Pricing publication*.

1. Two-Wire/Four-Wire WATS Access Line (a.k.a. BellSouth SPA WATS Line)

a. Local Channel

(1) Per Point of Termination

	Monthly Rate	Nonrecurring Charge		USOC
		First Service Installed	Additional Service Installed	
(a) Per Two-Wire Line	\$32.50(I)	\$255.00	131.00	X2W
(b) Per Four-Wire Line	52.00(I)	260.00	135.00	X4W

2. Interoffice Channel

a. Miles

	Fixed Monthly Charge	Monthly Charge Per Mile	Nonrecurring Charge	USOC
(a) 0	\$-	\$-	\$-	1LFFX
(b) 1 and above	13.00	2.24	78.40	1LFFX

Note 1: The key activated control channel is rates as Metallic (a.k.a. BellSouth SPA Metallic) Local Channel (use USOC T6EME in lieu of T6ECS) and Interoffice Channel, if applicable (use USOC 1L5MX in lieu of 1L5XX).

Note 2: The Dial-up option requires the purchase of the Controller Arrangement (USOC XTDDU) from E13.3.8 following.

Note 3: An additional Local Channel charge will apply whenever a spare channel is configured as a leg to the premises. Additional Interoffice Channel charges will also apply when the transfer arrangement is not located in the premises serving wire center.

Note 4: Effective June 30, 2021, this Service will no longer be available for purchase by new or existing customers. In addition, requests to move, add, change, or renew existing service arrangements will not be accepted. Following the expiration of a customer's existing term agreement, service will be provided on a month-to-month basis at the applicable Monthly rates until the service is discontinued. The Company currently plans to discontinue this service on or after June 30, 2024.

(N)

(N)

E7. SPECIAL ACCESS (A.K.A. BELLSOUTH SPA) SERVICE

E7.5 Rates and Charges (Cont'd)

E7.5.7 Voice Grade¹ (a.k.a. BellSouth SPA DS0 VG) Service (Cont'd)

(C)

D. WATS Access Line¹ (Cont'd)

(C)

3. Optional Features

a. Improved Two-Wire Voice Transmission Specifications

(1) For WATS Access Line (a.k.a. BellSouth SPA WATS Line)

	Monthly Rate	Nonrecurring Charge		USOC
		Initial	Subsequent	
(a) Two-Wire	\$10.00	\$20.78	\$68.20	X2T

b. WATS Access Line (a.k.a. BellSouth SPA WATS Line) Bridging

(1) Two-Wire/Four-Wire, per port

	Monthly Rate	Nonrecurring Charge		USOC
(a) Two-Wire	\$4.96		31.88	BCNV2
(b) Four-Wire	4.96		39.70	BCNV4

E7.5.8 (DELETED)

Note 1: Effective June 30, 2021, this Service will no longer be available for purchase by new or existing customers. In addition, requests to move, add, change, or renew existing service arrangements will not be accepted. Following the expiration of a customer's existing term agreement, service will be provided on a month-to-month basis at the applicable Monthly rates until the service is discontinued. The Company currently plans to discontinue this service on or after June 30, 2024.

(N)

(N)

E7. SPECIAL ACCESS (A.K.A. BELL SOUTH SPA) SERVICE

E7.5 Rates and Charges (Cont'd)

E7.5.8 (DELETED) (Cont'd)

E7.5.9 Digital Data Access³ (a.k.a. BellSouth SPA DS0 Digital Data) Service

(C)

A. Local Channel

1. Per Point of Termination

			Month	24 to	43 to	
	Nonrecurring Charge		to	42	72	
	First	Add'l	Month	Months ^{1,2}	Months ^{1,2}	USOC
(a) 2.4 Kbps	\$365.00	\$120.00	\$48.00	\$45.00	\$40.00	T6ECS
(b) 4.8 Kbps	365.00	120.00	48.00	45.00	40.00	T6ECS
(c) 9.6 Kbps	365.00	120.00	48.00	45.00	40.00	T6ECS
(d) 19.2 Kbps	365.00	120.00	48.00	45.00	40.00	T6ECS
(e) 56.0 Kbps	365.00	120.00	64.00	60.00	55.00	T6ECS
(f) 64.0 Kbps	365.00	120.00	64.00	60.00	55.00	T6ECS

Note 1: Effective December 10, 2013, Customers may not establish new term plans greater than 36 months for Digital Data service and term plans may not be renewed for a term greater than 36 months.

Note 2: Effective March 25, 2019, Customers may not convert, renew or establish CSPPs for Digital Data Access Service.

Note 3: Effective June 30, 2021, this Service will no longer be available for purchase by new or existing customers. In addition, requests to move, add, change, or renew existing service arrangements will not be accepted. Following the expiration of a customer's existing term agreement, service will be provided on a month-to-month basis at the applicable Monthly rates until the service is discontinued. The Company currently plans to discontinue this service on or after June 30, 2024.

(N)

(N)

E7. SPECIAL ACCESS (A.K.A. BELLSOUTH SPA) SERVICE

E7.5 Rates and Charges (Cont'd)

E7.5.9 Digital Data Access³ (a.k.a. BellSouth SPA DS0 Digital Data) Service (Cont'd)

(C)

A. Local Channel (Cont'd)

2. Hub Termination, per Local Channel

	Nonrecurring Charge		Month 24 to 42	43 to 72	USOC	
	First	Add'l	Month	Months ^{1,2}	Months ^{1,2}	
(a) 2.4 Kbps	\$48.00	\$37.00	\$10.00	\$9.00	\$8.00	TUTA4
(b) 4.8 Kbps	48.00	37.00	10.00	9.00	8.00	TUTB4
(c) 9.6 Kbps	48.00	37.00	10.00	9.00	8.00	TUTC4
(d) 19.2 Kbps	48.00	37.00	10.00	9.00	8.00	TUTE4
(e) 56.0 Kbps	48.00	37.00	20.00	18.00	16.00	TUTD4
(f) 64.0 Kbps	48.00	37.00	20.00	18.00	16.00	TUTF4

B. Interoffice Channel

1. 2.4 Kbps

Mileage Bands

	Fixed Monthly Charge	Monthly Charge Per Mile	Nonrecurring Charge	USOC
(a) 0	\$-	\$-	\$-	1L5XX
(b) 1 and above	20.00	1.45	99.00	1L5XX

2. 4.8 Kbps

Mileage Bands

(a) 0	-	-	-	1L5XX
(b) 1 and above	20.00	1.45	99.00	1L5XX

3. 9.6 Kbps

Mileage Bands

(a) 0	-	-	-	1L5XX
(b) 1 and above	20.00	1.45	99.00	1L5XX

Note 1: Effective December 10, 2013, Customers may not establish new term plans greater than 36 months for Digital Data service and term plans may not be renewed for a term greater than 36 months.

Note 2: Effective March 25, 2019, Customers may not convert, renew or establish CSPPs for Digital Data Access Service.

Note 3: Effective June 30, 2021, this Service will no longer be available for purchase by new or existing customers. In addition, requests to move, add, change, or renew existing service arrangements will not be accepted. Following the expiration of a customer's existing term agreement, service will be provided on a month-to-month basis at the applicable Monthly rates until the service is discontinued. The Company currently plans to discontinue this service on or after June 30, 2024.

(N)
|
(N)

E7. SPECIAL ACCESS (A.K.A. BELLSOUTH SPA) SERVICE

E7.5 Rates and Charges (Cont'd)

E7.5.9 Digital Data Access¹ (a.k.a. BellSouth SPA DS0 Digital Data) Service (Cont'd)

(C)

B. Interoffice Channel (Cont'd)

4. 19.2 Kbps

Mileage Bands

		Fixed Monthly Charge	Monthly Charge Per Mile	Nonrecurring Charge	USOC
(a)	0	\$-	\$-	\$-	1L5XX
(b)	1 and above	20.00	1.45	99.00	1L5XX
5.	56.0 Kbps				
	Mileage Bands				
(a)	0	-	-	-	1L5XX
(b)	1 and above	30.00	2.90	99.00	1L5XX
6.	64.0 Kbps				
	Mileage Bands				
(a)	0	-	-	-	1L5XX
(b)	1 and above	30.00	2.90	99.00	1L5XX

7. 2.4, 4.8, 9.6, or 19.2 Kbps (Contract Rates)

Mileage Bands

		Nonrecurring Charge Per Channel	Fixed 24 to 42 Months	43 to 72 Month	Per Mile 24 to 42 Months	43 to 72 Months	USOC
(a)	0	\$-	\$-	\$-	\$-	\$-	1L5XX
(b)	1 and above	99.00	18.00	16.00	1.25	1.00	1L5XX
8.	56.0 or 64.0 Kbps (Contract Rates)						
	Mileage Bands						
(a)	0	-	-	-	-	-	1L5XX
(b)	1 and above	99.00	28.00	25.00	2.50	2.00	1L5XX

Note 1: Effective June 30, 2021, this Service will no longer be available for purchase by new or existing customers. In addition, requests to move, add, change, or renew existing service arrangements will not be accepted. Following the expiration of a customer's existing term agreement, service will be provided on a month-to-month basis at the applicable Monthly rates until the service is discontinued. The Company currently plans to discontinue this service on or after June 30, 2024.

(N)
|
(N)

E7. SPECIAL ACCESS (A.K.A. BELLSOUTH SPA) SERVICE

E7.5 Rates and Charges (Cont'd)

E7.5.9 Digital Data Access⁷ (a.k.a. BellSouth SPA DS0 Digital Data) Service (Cont'd)

(C)

C. Optional Features and Functions

1. Bridging^{1,2}

	Nonrecurring Charge	Month to Month	24 to 42 Months ^{5,6}	43 to 72 Months ^{5,6}	USOC
(a) Per port (2.4, 4.8, 9.6, 19.2, 56.0 Kbps)	\$22.00	\$15.00	\$12.00	\$10.00	BCNDA

2. Digital Data Secondary Channel Capability, per Local Channel^{1,2,3}

(a) Each	160.00	10.00	7.50	5.00	SFS
----------	--------	-------	------	------	-----

3.

E7.5.10 High Capacity (a.k.a. BellSouth SPA High Capacity) Service

A. Local Channel

1. Per Point of Termination

	Monthly Rate	Nonrecurring Charge		USOC
		First Service Installed	Additional Service Installed	
(a) 1.544 Mbps	\$215.00	\$837.92	\$494.19	TMEC
(b) 3.152 Mbps ⁴	-	-	-	TWT+
(c) 6.312 Mbps ⁴	-	-	-	TWT+
(d) 44.736 Mbps ⁴	-	-	-	TWT+

Note 1: This option is not available with 64.0 Kbps.

Note 2: Not available at all service locations.

Note 3: Nonrecurring charge is applicable only if Secondary Channel service is being added subsequent to the installation of basic service.

Note 4: ICB rates and charges apply.

Note 5: Effective December 10, 2013, Customers may not establish new term plans greater than 36 months for Digital Data service and term plans may not be renewed for a term greater than 36 months.

Note 6: Effective March 25, 2019, Customers may not convert, renew or establish CSPPs for Digital Data Access Service.

Note 7: Effective June 30, 2021, this Service will no longer be available for purchase by new or existing customers. In addition, requests to move, add, change, or renew existing service arrangements will not be accepted. Following the expiration of a customer's existing term agreement, service will be provided on a month-to-month basis at the applicable Monthly rates until the service is discontinued. The Company currently plans to discontinue this service on or after June 30, 2024.

(N)
|
(N)

E7. SPECIAL ACCESS (A.K.A. BELLSOUTH SPA) SERVICE

E7.5 Rates and Charges (Cont'd)

E7.5.10 High Capacity (a.k.a. BellSouth SPA High Capacity) Service (Cont'd)

B. Interoffice Channel

- 1. 1.544 Mbps
Mileage Bands

	Fixed Monthly Rate	Monthly Rate Per Mile	Nonrecurring Charge	USOC	
(a) 1 thru 8	\$75.00	\$23.00	\$103.39	1L5XX	(R)
(b) 9 thru 25	75.00	23.00	103.39	1L5XX	(R)
(c) Over 25	75.00	23.00	103.39	1L5XX	(R)

- 2. 3.152 Mbps
Mileage Bands

(a) 1 thru 8 ¹	-	-	-	1L5XX	
(b) 8 thru 25 ¹	-	-	-	1L5XX	
(c) Over 25 ¹	-	-	-	1L5XX	

- 3. 6.312 Mbps
Mileage Bands

(a) 1 thru 8 ¹	-	-	-	1L5XX	
(b) 8 thru 25 ¹	-	-	-	1L5XX	
(c) Over 25 ¹	-	-	-	1L5XX	

- 4. 44.736 Mbps
Mileage Bands

(a) 1 thru 8 ¹	-	-	-	1L5XX	
(b) 8 thru 25 ¹	-	-	-	1L5XX	
(c) Over 25 ¹	-	-	-	1L5XX	

Note 1: ICB rates and charges apply.

E7. SPECIAL ACCESS (A.K.A. BELLSOUTH SPA) SERVICE

E7.5 Rates and Charges (Cont'd)

E7.5.10 High Capacity (a.k.a. BellSouth SPA High Capacity) Service (Cont'd)

C. Optional Features and Functions

1. Channelization

a. DS3 Channelization

(1) DS3to DS1

(a) Per arrangement¹

b. DS2 Channelization

(1) DS2 to DS1

(a) Per arrangement¹

c. DS1C Channelization

(1) DS1C to DS1

(a) Per arrangement¹

d. DS1 Channelization

(1) DS1 Basic Channelization System (DS1 to VG/DS0)

(a) Per System

e. DS0 Channelization²

(1) DS0 Basic Channelization System (DS0 to Subrate²)

(a) Maximum of 20, 2.4 Kbps services

(b) Maximum of 10, 4.8 Kbps services

(c) Maximum of 5, 9.6 Kbps services

	Monthly Rate	Nonrecurring Charge	USOC
	\$-	\$-	MXB++
	-	-	MXD++
	-	-	MXH++
	210.00	135.00	MQ1
	120.00	135.00	QSU24
	120.00	135.00	QSU48
	120.00	135.00	QSU96

Note 1: ICB rates and charges apply.

Note 2: Effective June 30, 2021, this Service will no longer be available for purchase by new or existing customers. In addition, requests to move, add, change, or renew existing service arrangements will not be accepted. Following the expiration of a customer's existing term agreement, service will be provided on a month-to-month basis at the applicable Monthly rates until the service is discontinued. The Company currently plans to discontinue this service on or after June 30, 2024.

(C)

(C)

(N)

(N)

E7. SPECIAL ACCESS (A.K.A. BELLSOUTH SPA) SERVICE

E7.5 Rates and Charges (Cont'd)

E7.5.10 High Capacity (a.k.a. BellSouth SPA High Capacity) Service (Cont'd)

C. Optional Features and Functions (Cont'd)

2. Channel Interfaces (Per Interface)

a. Sub-DS3 Interfaces

(1) DS1 Level Central Office Channel Interface¹

	Month to Month USOC	24 to 48 Months ^{3,7, 8}	49 to 72 Months ^{3,4,7}	73 to 96 Months ^{3,4,7}	Nonrecurring Charge	
(a) Asynchronous	\$12.00	\$8.00	\$7.00	\$6.00	\$155.00	1D3CA
(b) Synchronous	36.00	31.00	28.00	25.00	130.00	1D3CS

(2) DS1 Level Customer Channel Interface¹

(a) Asynchronous	17.00	13.00	13.00	13.00	305.00	1D3DA
(b) Synchronous	45.00	36.00	33.00	30.00	250.00	1D3DS

b. Sub-DS1 Interfaces

(1) VG/DS0 Level Central Office Channel Interface

	First	Additional	Nonrecurring Monthly Rate	USOC
(a) BellSouth SWA	\$0.00	\$0.00	\$0.00	1D1SW
(b) Metallic ⁶ (a.k.a. BellSouth SPA Metallic)	7.00	6.00	16.00	1D1ME
(c) Telegraph ⁶ (a.k.a. BellSouth SPA Telegraph)	7.00	6.00	5.00	1D1TE
(d) Voice Grade ⁶ (a.k.a. BellSouth SPA DS0 VG)	7.00	6.00	6.50	1D1VG
(e) WATS Access Line ⁶ (a.k.a. BellSouth SPA WATS Line)	7.00	6.00	6.50	1D1WT
(f) (DELETED)				
(g) (DELETED)				
(h) DDAS ⁶ (a.k.a. BellSouth SPA DS0 Digital Data)	7.00	6.00	13.00	1D1DD

c. Sub-DS0 Level Interfaces⁶

(1) Subrate Level Central Office Channel Interface

(a) Subrate (2.4, 4.8, & 9.6 Kbps)	7.00	6.00	13.00	1DOSR
------------------------------------	------	------	-------	-------

3.

4. Clear Channel Capability is furnished on a per DS1 Service Channel basis Per Point-to-Point DS1/1.544 Mbps High Capacity optioned as:

(a) Superframe Format (SF)	-	-	615.00	CCOSF
(b) Extended Superframe Format (ESF)	-	-	615.00	CCOEF

Note 1: Contract lengths are flexible to allow customer choice of payment period per E2.4.9.

Note 2: An additional Local Channel charge will apply whenever the spare line is provided as a leg to the end user premises.

Note 3: Effective December 10, 2013, Customers may not establish new term plans greater than 36 months for High Capacity Service and term plans may not be renewed for a term greater than 36 months.

Note 4: Effective March 25, 2019, Customers may not convert or renew CSPPs for High Capacity Service.

Note 5: **(DELETED)**

Note 6: Effective June 30, 2021, this Service will no longer be available for purchase by new or existing customers. In addition, requests to move, add, change, or renew existing service arrangements will not be accepted. Following the expiration of a customer's existing term agreement, service will be provided on a month-to-month basis at the applicable Monthly rates until the service is discontinued. The Company currently plans to discontinue this service on or after June 30, 2024.

Note 7: Effective November 1, 2022, customers may not establish new term plans of greater than 24 months for High Capacity Service Channel Service Payment Plans.

Note 8: Effective March 17, 2024, customers may not establish new term plans of greater than month-to-month for High Capacity Service Channel Service Payment Plans.

(C)

(N)

E7. SPECIAL ACCESS (A.K.A. BELLSOUTH SPA) SERVICE

E7.5 Rates and Charges (Cont'd)

E7.5.10 High Capacity (a.k.a. BellSouth SPA High Capacity) Service (Cont'd)

C. Optional Features and Functions (cont'd)

- 5. Virtual Collocation to High Capacity (a.k.a. BellSouth SPA High Capacity) Service (N)

	Nonrecurring Charge		Monthly	USOC	
	First	Additional	Rate	CNC1X	(N)
(a) Per DS1 Cross-Connect	\$155.00	\$14.00	\$7.50		

D. Network Channel Terminating Equipment (NCTE)¹

- 1. Per Point of Termination where provided

	Monthly	Nonrecurring	USOC
	Rate	Charge	TN615
(a) 1.544 Mbps	\$41.06	\$-	

E7.5.11 Message Station Equipment Recovery Charge

A. Message Station Equipment Recovery Charge

- 1. Per Special Access (a.k.a. BellSouth SPA) Surcharge Assessed

	Monthly	USOC
	Rate	UTM
(a) Each	\$3.41	

Note 1: ICB rates and charges apply.

E7. SPECIAL ACCESS (A.K.A. BELLSOUTH SPA) SERVICE

E7.5 Rates and Charges (Cont'd)

E7.5.12 Special Access (a.k.a. BellSouth SPA) Surcharge

A. Rates

- 1. Per Voice Grade Equivalent

- (a) Each

Monthly Rate	USOC
\$25.00	\$25

E7.5.13 Transfer of Service

A. Service Rearrangements

- 1. Special Access (a.k.a. BellSouth SPA) Circuits

- (a) Per Billing Account Number
- (b) Per circuit

Nonrecurring Charge	USOC
\$140.00	NRBPA
7.00	NRBPC

E7.5.14 Reserved for Future Use

(DELETED)

(DELETED)

(T)

E7. SPECIAL ACCESS (A.K.A. BELL SOUTH SPA) SERVICE

E7.5 Rates and Charges (Cont'd)

E7.5.14 (DELETED) (Cont'd)

E7.5.15 Derived Data Channel¹ (a.k.a. BellSouth SPA Derived Data Channel) Service

(C)

A. Local Channel

1. Derived Data Channel

	Nonrecurring Charge	Month to Month	24 to 42 Months	43 to 72 Months	USOC
(a) Per channel at 2.4 Kbps	\$360.00	\$17.00	\$13.50	\$11.00	DAXPC
2. DS0-B Interface					
(a) Per group of twenty Derived Data Channels	400.00	90.00	88.00	86.00	DAXPI

(DELETED)

Note 1: Effective June 30, 2021, this Service will no longer be available for purchase by new or existing customers. In addition, requests to move, add, change, or renew existing service arrangements will not be accepted. Following the expiration of a customer's existing term agreement, service will be provided on a month-to-month basis at the applicable Monthly rates until the service is discontinued. The Company currently plans to discontinue this service on or after June 30, 2024.

(N)

(N)

E7. SPECIAL ACCESS (A.K.A. BELL SOUTH SPA) SERVICE

E7.5 Rates and Charges (Cont'd)

E7.5.15 Derived Data Channel⁵ (a.k.a. BellSouth SPA Derived Data Channel) Service (Cont'd)

(C)

B. Interoffice Channel

1. DS0-B Interoffice Channel, Per DS0-B Interface

	Nonrecurring Charge	Month to Month	Month to 24 Months ^{2,4}	24 to 42 Months ^{2,4}	43 to 72 Months ^{2,4}	USOC
(a) Fixed	\$15.00	\$5.00	\$4.00	\$3.00		DAXPF
(b) Each mile or fraction thereof	-	1.00	.75	.50		DAXPM

E7.5.16 BellSouth SPA CNM - FlexServ Service

A. Basic BellSouth SPA CNM - FlexServ Service

1. DS0 Channel Connections

	Nonrecurring Charge	Month To Month	Month to 24 Months ^{3,4}	24 to 49 Months ^{3,4}	49 to 73 Months ^{3,4}	USOC
(a) Voice Grade Type, per DS0 channel	\$35.00	\$13.85	\$12.75	\$11.75	\$11.00	DSLVA
(b) Digital Type, per DS0 channel	35.00	5.75	5.30	4.90	4.60	DSLDA
2. DS1 Channel Connections						
(a) DS0 Switching, per DS1 channel	125.00	80.00	75.00	70.00	65.00	DSL1A
(b) DS1 Switching, per DS1 channel	125.00	48.00	44.00	41.00	38.00	DSL1B
(c) Surveillance - DS1 Level per DS1 channel	125.00	48.00	44.00	41.00	38.00	DSL1S
3. DS3 Channel Connections						
(a) Surveillance - DS1 Level, per DS3 channel	125.00	375.00	345.00	320.00	300.00	DSL3S
(b) Surveillance - DS3 Level, per DS3 channel	125.00	150.00	138.00	128.00	120.00	DSL3T

B. BellSouth SPA CNM - FlexServ Service

1. Multipoint Bridging

(a) Voice Grade Connections, per bridging leg	20.00	3.90	3.50	3.40	3.30	FSSF9
(b) Multipoint Junction Unit, per 2.4, 4.8, 9.6 or 56 Kbps channel ¹	15.00	5.15	4.75	4.25	4.00	FSSFJ
(c) Multipoint Junction Unit, per 19.2 Kbps channel ¹	15.00	9.45	8.90	8.40	7.90	FSSF9

Note 1: Must purchase in units of five.

Note 2: Effective December 10, 2013, Customers may not establish new term plans greater than 36 months for Derived Data Channel service and term plans may not be renewed for a term greater than 36 months.

Note 3: Effective December 10, 2013, Customers may not establish new term plans greater than 36 months for BellSouth SPA CNM - FlexServ Service and term plans may not be renewed for a term greater than 36 months.

Note 4: Effective March 25, 2019, Customers may not convert, renew or establish CSPPs for Derived Data Channel Service and BellSouth SPA CNM - FlexServ Service.

Note 5: Effective June 30, 2021, this Service will no longer be available for purchase by new or existing customers. In addition, requests to move, add, change, or renew existing service arrangements will not be accepted. Following the expiration of a customer's existing term agreement, service will be provided on a month-to-month basis at the applicable Monthly rates until the service is discontinued. The Company currently plans to discontinue this service on or after June 30, 2024.

(N)
|
(N)

E7. SPECIAL ACCESS (A.K.A. BELLSOUTH SPA) SERVICE

E7.5 Rates and Charges (Cont'd)

E7.5.16 BellSouth SPA Customer Network Management (CNM) - FlexServ Service (Cont'd)

B. BellSouth SPA CNM - FlexServ Service Options (Cont'd)

2. Subrate Reconfiguration Capability

		Nonrecurring Charge				USOC	
		\$45.00				DSLSB	
		Nonrecurring Charge	Month To Month	24 to 48 Months¹	49 to 72 Months^{1,2}	73 to 96 Months^{1,2}	USOC
(a)	Per DS0 equipped (DS0B)						
(b)	9.6 Kbps, per DS0A requires 5	\$5.00	\$7.75	\$7.00	\$6.60	\$6.20	DSLS9
(c)	4.8 Kbps, per DS0A requires 10	5.00	7.30	6.70	6.20	5.85	DSLS4
(d)	2.4 Kbps, per DS0A requires 20	5.00	6.90	6.35	5.90	5.50	DSLS2
3.	Additional Concurrent User Access						
(a)	Per Additional User Access	125.00	63.00	60.00	57.00	54.00	FSSFU
4.	Additional User Identification Codes						
(a)	Per Additional Code					Nonrecurring Charge	USOC
5.	Additional Customer Training					\$3.00	FSSFA
(a)	Per eight hour day of training after initial installation				450.00		FSSFT
6.	Reconfiguration by Company Personnel						
(a)	Request for Company to perform reconfiguration activity				25.00		FSSRA

Note 1: Effective December 10, 2013, Customers may not establish new term plan greater than 36 months for BellSouth SPA CNM - FlexServ Service and term plans may not be renewed for a term greater than 36 months.

Note 2: Effective March 25, 2019, Customers may not convert, renew or establish CSPPs for BellSouth SPA CNM - FlexServ Service. (N)

E7. SPECIAL ACCESS (A.K.A. BELL SOUTH SPA) SERVICE

E7.5 Rates and Charges (Cont'd)

E7.5.17 SMARTRing[®] service (a.k.a. BellSouth Dedicated Ring)

(C)

A. Self-healing Multi-nodal Alternate Route Topology Ring - Month-to-Month

1. Local Channel (All capacities except OC-1)

	Month-to-Month	Nonrecurring Charge	USOC
(a) Per Local Channel	-	\$405.00	1HVXX
(b) Per Quarter Air Mile	\$95.00	-	1HVXX

2. Alternate Central Office (All capacities except OC-1)

(a) Per Alternate C.O. Channel	-	435.00	1HAXX
(b) Per Quarter Air Mile	1,500.00	-	1HAXX

3. Interoffice Channel (All capacities except OC-1)

(a) Per Channel, except OC-192 and OC-192+ Capacity	-	130.00	1HXFX
(b) Fixed, OC-3 Capacity	50.00	-	1HXFX
(c) Fixed, OC-3+, OC-12, OC-48 or OC-48+ Capacity	175.00	-	1HXFX
(d) Fixed, OC-192 or OC-192+ Capacity	600.00	300.00	1HXFX
(e) Per Quarter Air Mile, OC-3 Capacity	45.00	-	1HXFX
(f) Per Quarter Air Mile, OC-3+, OC-12, OC-48 or OC-48+ Capacity	55.00	-	1HXFX
(g) Per Quarter Air Mile, OC-192 or OC-192+ Capacity	55.00	-	1HXFX

4. Internodal Channel (All capacities except OC-1)

(a) Per Internodal Channel, Same Wire Center Area, Per Quarter Air Mile	3,000.00	430.00	1HNXX
(b) Per Internodal Channel, Same Office Park/Campus Environment in Contiguous Serving Wire Center Areas, Per Quarter Air Mile	3,500.00	430.00	1HNZX

5. Customer Node (Per Customer Node)

(a) OC-1 Capacity	800.00	425.00	SHNC4
(b) OC-3 Capacity	2,200.00	455.00	SHNC3
(c) OC-3+ Capacity	3,000.00	455.00	SHNN5
(d) OC-12 Capacity	3,400.00	455.00	SHNC1
(e) OC-48 Capacity	5,800.00	455.00	SHNN8
(f) OC-48+ Capacity	6,500.00	455.00	SHNN9
(g) OC-192 Capacity	25,000.00	640.00	SHNN6
(h) OC-192+ Capacity	25,000.00	640.00	SHNN2

Note 1: Effective on or after December 1, 2021, neither new nor existing customers will be permitted to purchase new SMARTRing Service (Service). In addition, (A) Service Payment Plans greater than 12-months in length will no longer be available; and (B) requests to move, add, change, upgrade, or downgrade existing service arrangements will not be accepted, with the following exceptions: (1) existing customers will be permitted to modify their existing Service and will be able to add new circuits to their existing Service, but will not be permitted to add new nodes in any locations; and (2) any such new circuits will be subject to the customer's existing term payment plan or term agreement for the Service to which they are added. Following the expiration of a customer's existing term agreement, Service will be provided on a month-to-month basis at the applicable Month-to-Month rates until the Service is discontinued.

(N)

Effective November 30, 2023, unless specified to the contrary in their existing Service agreements, existing customers may not renew Term Payment Plans or term agreements for Service. In addition, no move, add, or change orders of any type will be accepted.

(N)

E7. SPECIAL ACCESS (A.K.A. BELLSOUTH SPA) SERVICE

E7.5 Rates and Charges (Cont'd)

E7.5.17 SMARTRing² service (a.k.a. BellSouth Dedicated Ring) (Cont'd)

(C)

A. Self-healing Multi-nodal Alternate Route Topology Ring - Month-to-Month (Cont'd)

6. Customer Channel Interface (Per Customer Node)

	Month-to-Month	Nonrecurring Charge	USOC
(a) Per DS1	\$35.00	\$235.00	SHNBB
(b) Per DS3	170.00	105.00	SHNZT
(c) Per STS-1	220.00	105.00	SHN13
(d) Per OC-1	100.00	115.00	SHN1C
(e) Per OC-3, 2-Fiber	240.00	110.00	SHN1D
(f) Per OC-3, 4-Fiber	475.00	110.00	SHN15
(g) Per OC-12, 2-Fiber	715.00	115.00	SHN1F
(h) Per OC-12, 4-Fiber	1,430.00	115.00	SHN19
(i) Per OC-48, 2-Fiber	1,600.00	640.00	SHN1A
(j) Per OC-48, 4-Fiber	3,200.00	640.00	SHN1B
(k) Per 1000 Mbps	740.00	540.00	SHN1K
(l) Per 100 Mbps (1 STS-1) BellSouth Metro Ethernet ¹ Backbone	500.00	800.00	SHN1J
(m) Per 100 Mbps (3 STS-1) BellSouth Metro Ethernet ¹ Backbone	540.00	800.00	SHN33
(n) Per 1000 Mbps BellSouth Metro Ethernet ¹ Backbone	740.00	850.00	SHN34
(o) Per Fractional 1000 Mbps Metro Ethernet ¹ Backbone			
- 150 Mbps (3 STS-1)	560.00	850.00	SHN35
- 300 Mbps (6 STS-1)	600.00	850.00	SHN36
- 450 Mbps (9 STS-1)	640.00	850.00	SHN37
- 600 Mbps (12 STS-1)	700.00	850.00	SHN38
7. Central Office Node (Per Central Office Node)			
(a) OC-1 Capacity	600.00	415.00	SHNH4
(b) OC-3 Capacity	1,400.00	460.00	SHNH3
(c) OC-3+ Capacity	2,500.00	460.00	SHNH5
(d) OC-12 Capacity	2,600.00	455.00	SHNH1
(e) OC-48 Capacity	5,400.00	455.00	SHNH8
(f) OC-48+ Capacity	6,100.00	455.00	SHNH9
(g) OC-192 Capacity	25,000.00	640.00	SHNH7
(h) OC-192+ Capacity	25,000.00	640.00	SHNH6
(i) OC-3 Shared Node Interconnection	980.00	550.00	SHNHE
(j) OC-12 Shared Node Interconnection	1,820.00	550.00	SHNHE
(k) OC-48 Shared Node Interconnection	3,400.00	550.00	SHNHE
(l) OC-48+ Shared Node Interconnection	3,840.00	550.00	SHNHE

Note 1: Effective on or after August 22, 2021, this Service will no longer be available for purchase by new or existing customers. In addition, requests to move, add, change, or renew existing service arrangements will not be accepted. Following the expiration of a customer's existing term agreement, service will be provided on a month-to-month basis at the applicable Monthly rates until the service is discontinued. The Company currently plans to discontinue this service on or after March 31, 2023.

Note 2: Effective on or after December 1, 2021, neither new nor existing customers will be permitted to purchase new SMARTRing Service (Service). In addition, (A) Service Payment Plans greater than 12-months in length will no longer be available; and (B) requests to move, add, change, upgrade, or downgrade existing service arrangements will not be accepted, with the following exceptions: (1) existing customers will be permitted to modify their existing Service and will be able to add new circuits to their existing Service, but will not be permitted to add new nodes in any locations; and (2) any such new circuits will be subject to the customer's existing term payment plan or term agreement for the Service to which they are added. Following the expiration of a customer's existing term agreement, Service will be provided on a month-to-month basis at the applicable Month-to-Month rates until the Service is discontinued.

(N)

Effective November 30, 2023, unless specified to the contrary in their existing Service agreements, existing customers may not renew Term Payment Plans or term agreements for Service. In addition, no move, add, or change orders of any type will be accepted.

(N)

E7. SPECIAL ACCESS (A.K.A. BELLSOUTH SPA) SERVICE

E7.5 Rates and Charges (Cont'd)

E7.5.17 SMARTRing² service (a.k.a BellSouth Dedicated Ring) (Cont'd)

(C)

- A. Self-healing Multi-nodal Alternate Route Topology Ring - Month-to-Month (Cont'd)
 - 8. Central Office Channel Interface (Per Central Office Node)

	Month-to- Month	Nonrecurring Charge	USOC
(a) Per DS1	\$35.00	\$98.00	SHNCB
(b) Per DS3	115.00	150.00	SHNYT
(c) Per STS-1	150.00	155.00	SHNO2
(d) Per OC-1	100.00	170.00	SHNCC
(e) Per OC-3, 2-Fiber	240.00	99.00	SHNCD
(f) Per OC-3, 4-Fiber	425.00	99.00	SHNO4
(g) Per OC-12, 2-Fiber	640.00	99.00	SHNCF
(h) Per OC-12, 4-Fiber	1,280.00	99.00	SHNC9
(i) Per OC-48, 2-Fiber	1,600.00	640.00	SHNCJ
(j) Per OC-48, 4-Fiber	3,200.00	640.00	SHNCK
(k) Per 28 DS1 Channel System - DS3	650.00	130.00	SHNW8
(l) Per 28 DS1 Channel System - STS-1	750.00	130.00	SHNCS
(m) Per DS1 on 28 DS1 Channel System - DS3	12.00	125.00	SHNCA
(n) Per DS1 on 28 DS1 Channel System - STS-1	40.00	81.00	SHNCG
(o) Per 1000 Mbps	740.00	400.00	SHNCW
(p) Per 100 Mbps (1 STS-1) BellSouth Metro Ethernet ¹ Backbone	500.00	800.00	SHNOJ
(q) Per 100 Mbps (3 STS-1) BellSouth Metro Ethernet ¹ Backbone	540.00	800.00	SHNCX
(r) Per 1000 Mbps BellSouth Metro Ethernet ¹ Backbone	740.00	850.00	SHNC5
(s) Per Fractional 1000 Mbps Metro Ethernet ¹ Backbone			
- 150 Mbps (3 STS-1)	560.00	850.00	SHND5
- 300 Mbps (6 STS-1)	600.00	850.00	SHND6
- 450 Mbps (9 STS-1)	640.00	850.00	SHND7
- 600 Mbps (12 STS-1)	700.00	850.00	SHND8

Note 1: Effective on or after August 22, 2021, this Service will no longer be available for purchase by new or existing customers. In addition, requests to move, add, change, or renew existing service arrangements will not be accepted. Following the expiration of a customer's existing term agreement, service will be provided on a month-to-month basis at the applicable Monthly rates until the service is discontinued. The Company currently plans to discontinue this service on or after March 31, 2023.

Note 2: Effective on or after December 1, 2021, neither new nor existing customers will be permitted to purchase new SMARTRing Service (Service). In addition, (A) Service Payment Plans greater than 12-months in length will no longer be available; and (B) requests to move, add, change, upgrade, or downgrade existing service arrangements will not be accepted, with the following exceptions: (1) existing customers will be permitted to modify their existing Service and will be able to add new circuits to their existing Service, but will not be permitted to add new nodes in any locations; and (2) any such new circuits will be subject to the customer's existing term payment plan or term agreement for the Service to which they are added. Following the expiration of a customer's existing term agreement, Service will be provided on a month-to-month basis at the applicable Month-to-Month rates until the Service is discontinued.

(N)

Effective November 30, 2023, unless specified to the contrary in their existing Service agreements, existing customers may not renew Term Payment Plans or term agreements for Service. In addition, no move, add, or change orders of any type will be accepted.

(N)

E7. SPECIAL ACCESS (A.K.A. BELL SOUTH SPA) SERVICE

E7.5 Rates and Charges (Cont'd)

E7.5.17 SMARTRing² service (a.k.a BellSouth Dedicated Ring) (Cont'd)

B. Self-healing Multi-nodal Alternate Route Topology Ring - Transport Payment Plan

1. Local Channel (All capacities except OC-1)

		Per Month Rates			
		A	B	C	
		12-36	37-60	61-96	USOC
		Months ²	Months ^{1,2}	Months ^{1,2}	
	(a) Per Quarter Air Mile	\$85.00	\$75.00	\$70.00	1HVXX
2.	Alternate Central Office (All capacities except OC-1)				
	(a) Per Quarter Air Mile	400.00	250.00	200.00	1HAXX
3.	Interoffice Channel (All capacities except OC-1)				
	(a) Fixed, OC-3 Capacity	40.00	35.00	30.00	1HXFX
	(b) Fixed, OC-3+, OC-12, OC-48 or OC-48+ Capacity	155.00	140.00	136.00	1HXFX
	(c) Fixed, OC-192 or OC-192+ Capacity	450.00	400.00	380.00	1HXFX
	(d) Per Quarter Air Mile, OC-3 Capacity	35.00	25.00	20.00	1HXFX
	(e) Per Quarter Air Mile, OC-3+, OC-12, OC-48 or OC-48+ Capacity	40.00	33.00	25.00	1HXFX
	(f) Per Quarter Air Mile, OC-192 or OC-192+ Capacity	40.00	33.00	25.00	1HXFX
4.	Internodal Channel (All capacities except OC-1)				
	(a) Per Internodal Channel, Same Wire Center Area, Per Quarter Air Mile	690.00	415.00	345.00	1HNXX
	(b) Per Internodal Channel, Same Office Park/Campus Environment in Contiguous Serving Wire Center Areas, Per Quarter Air Mile	780.00	465.00	390.00	1HNZX
5.	Customer Node (Per Customer Node)				
	(a) OC-1 Capacity	400.00	350.00	300.00	SHNC4
	(b) OC-3 Capacity	1,100.00	1,000.00	900.00	SHNC3
	(c) OC-3+ Capacity	2,050.00	1,750.00	1,500.00	SHNN5
	(d) OC-12 Capacity	2,200.00	2,000.00	1,750.00	SHNC1
	(e) OC-48 Capacity	4,900.00	4,500.00	3,900.00	SHNN8
	(f) OC-48+ Capacity	4,900.00	4,500.00	3,900.00	SHNN9
	(g) OC-192 Capacity	9,375.00	8,250.00	7,300.00	SHNN6
	(h) OC-192+ Capacity	9,375.00	8,250.00	7,300.00	SHNN2

Note 1: All term plans for SMARTRing[®] Service which are established, renewed or extended after December 10, 2013, for term lengths which are scheduled to expire at any time after February 1, 2019, will instead expire on February 1, 2019. All such services existing on or after February 1, 2019, will be provided on a month-to-month basis at the applicable, then current month-to-month rates.

Note 2: Effective on or after December 1, 2021, neither new nor existing customers will be permitted to purchase new SMARTRing Service (Service). In addition, (A) Service Payment Plans greater than 12-months in length will no longer be available; and (B) requests to move, add, change, upgrade, or downgrade existing service arrangements will not be accepted, with the following exceptions: (1) existing customers will be permitted to modify their existing Service and will be able to add new circuits to their existing Service, but will not be permitted to add new nodes in any locations; and (2) any such new circuits will be subject to the customer's existing term payment plan or term agreement for the Service to which they are added. Following the expiration of a customer's existing term agreement, Service will be provided on a month-to-month basis at the applicable Month-to-Month rates until the Service is discontinued.

Effective November 30, 2023, unless specified to the contrary in their existing Service agreements, existing customers may not renew Term Payment Plans or term agreements for Service. In addition, no move, add, or change orders of any type will be accepted.

E7. DEDICATED ACCESS SERVICES

E7.5 Rates and Charges (Cont'd)

E7.5.17 SMARTRing³ service (a.k.a BellSouth Dedicated Ring) (Cont'd)

B. Self-healing Multi-nodal Alternate Route Topology Ring - Transport Payment Plan (Cont'd)

6. Customer Channel Interface (Per Customer Node)

		Per Month Rates			
		A	B	C	
		12-36	37-60	61-96	USOC
		Months ³	Months ^{1,3}	Months ^{1,3}	
(a)	Per DS1	\$34.00	\$27.00	\$21.00	SHNBB
(b)	Per DS3	135.00	130.00	125.00	SHNZT
(c)	Per STS-1	170.00	150.00	140.00	SHN13
(d)	Per OC-1	90.00	80.00	75.00	SHN1C
(e)	Per OC-3, 2-Fiber	190.00	175.00	160.00	SHN1D
(f)	Per OC-3, 4-Fiber	380.00	350.00	320.00	SHN15
(g)	Per OC-12, 2-Fiber	570.00	525.00	480.00	SHN1F
(h)	Per OC-12, 4-Fiber	1,140.00	1,050.00	960.00	SHN19
(i)	Per OC-48, 2-Fiber	1,325.00	1,215.00	1,050.00	SHN1A
(j)	Per OC-48, 4-Fiber	2,650.00	2,430.00	2,100.00	SHN1B
(k)	Per 1000 Mbps	520.00	475.00	425.00	SHN1K
(l)	Per 100 Mbps (1 STS-1) BellSouth Metro Ethernet ² Backbone	175.00	155.00	140.00	SHN1J
(m)	Per 100 Mbps (3 STS-1) BellSouth Metro Ethernet ² Backbone	210.00	190.00	170.00	SHN33
(n)	Per 1000 Mbps BellSouth Metro Ethernet ² Backbone	520.00	475.00	425.00	SHN34
(o)	Per Fractional 1000 Mbps Metro Ethernet ² Backbone				
	- 150 Mbps (3 STS-1)	230.00	210.00	190.00	SHN35
	- 300 Mbps (6 STS-1)	300.00	280.00	260.00	SHN36
	- 450 Mbps (9 STS-1)	340.00	310.00	290.00	SHN37
	- 600 Mbps (12 STS-1)	380.00	340.00	320.00	SHN38
7.	Central Office Node (Per Central Office Node)				
(a)	OC-1 Capacity	400.00	350.00	300.00	SHNH4
(b)	OC-3 Capacity	1,100.00	1,000.00	900.00	SHNH3
(c)	OC-3+ Capacity	2,050.00	1,750.00	1,500.00	SHNH5
(d)	OC-12 Capacity	2,200.00	2,000.00	1,750.00	SHNH1
(e)	OC-48 Capacity	4,900.00	4,500.00	3,900.00	SHNH8
(f)	OC-48+ Capacity	4,900.00	4,500.00	3,900.00	SHNH9
(g)	OC-192 Capacity	9,375.00	8,250.00	7,300.00	SHNH7
(h)	OC-192+ Capacity	9,375.00	8,250.00	7,300.00	SHNH6
(i)	OC-3 Shared Node Interconnection	690.00	630.00	570.00	SHNHE
(j)	OC-12 Shared Node Interconnection	1,390.00	1,260.00	1,100.00	SHNHE
(k)	OC-48 Shared Node Interconnection	2,880.00	2,840.00	2,460.00	SHNHE
(l)	OC-48+ Shared Node Interconnection	2,880.00	2,840.00	2,460.00	SHNHE

Note 1: All term plans for SMARTRing[®] Service which are established, renewed or extended after December 10, 2013, for term lengths which are scheduled to expire at any time after February 1, 2019, will instead expire on February 1, 2019. All such services existing on or after February 1, 2019, will be provided on a month-to-month basis at the applicable, then current month-to-month rates.

Note 2: Effective on or after August 22, 2021, this Service will no longer be available for purchase by new or existing customers. In addition, requests to move, add, change, or renew existing service arrangements will not be accepted. Following the expiration of a customer's existing term agreement, service will be provided on a month-to-month basis at the applicable Monthly rates until the service is discontinued. The Company currently plans to discontinue this service on or after March 31, 2023.

Note 3: Effective on or after December 1, 2021, neither new nor existing customers will be permitted to purchase new SMARTRing Service (Service). In addition, (A) Service Payment Plans greater than 12-months in length will no longer be available; and (B) requests to move, add, change, upgrade, or downgrade existing service arrangements will not be accepted, with the following exceptions: (1) existing customers will be permitted to modify their existing Service and will be able to add new circuits to their existing Service, but will not be permitted to add new nodes in any locations; and (2) any such new circuits will be subject to the customer's existing term payment plan or term agreement for the Service to which they are added. Following the expiration of a customer's existing term agreement, Service will be provided on a month-to-month basis at the applicable Month-to-Month rates until the Service is discontinued.

Effective November 30, 2023, unless specified to the contrary in their existing Service agreements, existing customers may not renew Term Payment Plans or term agreements for Service. In addition, no move, add, or change orders of any type will be accepted.

E7. DEDICATED ACCESS SERVICES

E7.5 Rates and Charges (Cont'd)

E7.5.17 SMARTRing² service (a.k.a BellSouth Dedicated Ring) (Cont'd)

B. Self-healing Multi-nodal Alternate Route Topology Ring - Transport Payment Plan (Cont'd)

8. Central Office Channel Interface (Per Central Office Node)

		Per Month Rates			
		A	B	C	
		12-36	37-60	61-96	
		Months ²	Months ^{1,2}	Months ^{1,2}	USOC
(a)	Per DS1	\$30.00	\$25.00	\$20.00	SHNCB
(b)	Per DS3	85.00	80.00	75.00	SHNYT
(c)	Per STS-1	105.00	100.00	90.00	SHNO2
(d)	Per OC-1	90.00	80.00	75.00	SHNCC
(e)	Per OC-3, 2-Fiber	190.00	175.00	160.00	SHNCD
(f)	Per OC-3, 4-Fiber	330.00	300.00	270.00	SHNO4
(g)	Per OC-12, 2-Fiber	495.00	450.00	405.00	SHNCF
(h)	Per OC-12, 4-Fiber	990.00	900.00	810.00	SHNC9
(i)	Per OC-48, 2-Fiber	1,325.00	1,215.00	1,050.00	SHNCJ
(j)	Per OC-48, 4-Fiber	2,650.00	2,430.00	2,100.00	SHNCK
(k)	Per 28 DS1 Channel System - DS3	550.00	500.00	450.00	SHNW8
(l)	Per 28 DS1 Channel System - STS-1	650.00	600.00	575.00	SHNCS
(m)	Per DS1 on 28 DS1 Channel System - DS3	12.00	9.00	7.00	SHNCA
(n)	Per DS1 on 28 DS1 Channel System - STS-1	35.00	30.00	25.00	SHNCG
(o)	Per 1000 Mbps	520.00	475.00	425.00	SHNCW
(p)	Per 100 Mbps (1 STS-1) BellSouth Metro Ethernet Backbone	175.00	155.00	140.00	SHNOJ
(q)	Per 100 Mbps (3 STS-1) BellSouth Metro Ethernet Backbone	210.00	190.00	170.00	SHNCX
(r)	Per 1000 Mbps BellSouth Metro Ethernet Backbone	520.00	475.00	425.00	SHNC5
(s)	Per Fractional 1000 Mbps Metro Ethernet Backbone				
	- 150 Mbps (3 STS-1)	230.00	210.00	190.00	SHND5
	- 300 Mbps (6 STS-1)	300.00	280.00	260.00	SHND6
	- 450 Mbps (9 STS-1)	340.00	310.00	290.00	SHND7
	- 600 Mbps (12 STS-1)	380.00	340.00	320.00	SHND8

C. Self-healing Multi-nodal Alternate Route Topology Ring

1. Channel Interface Reallocation

		Nonrecurring Charge	USOC
(a)	Per Node, Per Occurrence	\$245.00	SHRBC

Note 1: All term plans for SMARTRing[®] Service which are established, renewed or extended after December 10, 2013, for term lengths which are scheduled to expire at any time after February 1, 2019, will instead expire on February 1, 2019. All such services existing on or after February 1, 2019, will be provided on a month-to-month basis at the applicable, then current month-to-month rates.

Note 2: Effective on or after December 1, 2021, neither new nor existing customers will be permitted to purchase new SMARTRing Service (Service). In addition, (A) Service Payment Plans greater than 12-months in length will no longer be available; and (B) requests to move, add, change, upgrade, or downgrade existing service arrangements will not be accepted, with the following exceptions: (1) existing customers will be permitted to modify their existing Service and will be able to add new circuits to their existing Service, but will not be permitted to add new nodes in any locations; and (2) any such new circuits will be subject to the customer's existing term payment plan or term agreement for the Service to which they are added. Following the expiration of a customer's existing term agreement, Service will be provided on a month-to-month basis at the applicable Month-to-Month rates until the Service is discontinued.

Effective November 30, 2023, unless specified to the contrary in their existing Service agreements, existing customers may not renew Term Payment Plans or term agreements for Service. In addition, no move, add, or change orders of any type will be accepted.

E7. SPECIAL ACCESS (A.K.A. BELLSOUTH SPA) SERVICE

E7.5 Rates and Charges (Cont'd)

E7.5.18 Reserved For Future Use.

E7.5.19 Reserved For Future Use.

(T)

E7. SPECIAL ACCESS (A.K.A. BELL SOUTH SPA) SERVICE

Cancellation Page

The following are virtual pages which replaced their previous revisions. As material is added to these pages, the pages will be filed with the next revision level and the virtual page appearance here will be deleted.

Page	Revision	Page	Revision	Page	Revision
		86	2	110	3
		87	4	111	3
		88	3	112	3
(DELETED)		89	9	113	4
(DELETED)		89.1	3	113.1	3
(DELETED)		90	8	114	3
(DELETED)		91	4	115	3
(DELETED)		91.1	1	116	3
(DELETED)		92	6	117	3
69	2	93	5	118	3
70	3	93.1	3	119	3
71	2	94	2	120	6
72	2	95	4	121	1
73	2	96	9	122	1
74	3	96.0.1	2	123	1
75	3	96.1	2	124	3
76	4	96.2	2	124.1	2
76.1	4	96.3	2	125	1
77	7	96.4	1	126	2
77.1	3	96.5	2	127	2
78	4	97	3	127.1	1
78.1	3	98	3	128	5
79	4	99	4	128.1	4
80	5	100	3	128.2	2
81	6	101	3	129	4
82	8	102	4	130	3
82.1	5	103	3	131	6
83	3	104	3	131.1	3
84	5	105	3	131.2	2
84.1	2	106	3	132	3
84.2	3	107	3	133	3
84.3	2	108	3	134	2
85	4	109	3	135	1
85.1	4				

(D)
(D)
(D)
(D)
(D)
(D)
(D)

E7. SPECIAL ACCESS (A.K.A. BELLSOUTH SPA) SERVICE

E7.5 Rates and Charges (Cont'd)

E7.5.20 Reserved For Future Use

E7.5.21 Reserved For Future Use

E7.5.22 BellSouth Metro Ethernet Service¹

A. Rates and charges for month-to-month service

1. Basic BellSouth Metro Ethernet Service Arrangements

(a) 2 Mbps Basic Connection

- Per Connection

	Nonrecurring Charge	Month to Month	USOC
	\$ 950.00	\$ 668.75	MTEBO

(b) 4 Mbps Basic Connection

- Per Connection

950.00 695.25 MTEB1

(c) 8 Mbps Basic Connection

- Per Connection

950.00 810.00 MTEB2

(d) 10 Mbps Basic Connection

- Per Connection

900.00 918.00 MTEBA

(e) 100 Mbps Basic Connection

- Per Connection

900.00 1,768.50 MTEBB

(f) 1 Gbps Basic Connection

- Per Connection

1,000.00 3,847.50 MTEBC

2. Premium BellSouth Metro Ethernet Service Arrangements

(a) 2 Mbps Premium Connection

- Per Connection, Fixed Mode

950.00 739.80 MTEPO

(b) 4 Mbps Premium Connection

- Per Connection, Fixed Mode

950.00 777.60 MTEP1

(c) 8 Mbps Premium Connection

- Per Connection, Fixed Mode

950.00 896.40 MTEP2

(d) 10 Mbps Premium Connection

- Per Connection, Fixed Mode

900.00 1,220.40 MTEP3

- Per Connection, Burst Mode

900.00 1,529.55 MTEE3

(e) 20 Mbps Premium Connection

- Per Connection, Fixed Mode

900.00 1,522.80 MTEP4

- Per Connection, Burst Mode

900.00 1,711.80 MTEE4

(f) 50 Mbps Premium Connection

- Per Connection, Fixed Mode

900.00 2,008.80 MTEP5

- Per Connection, Burst Mode

900.00 2,085.75 MTEE5

(g) 100 Mbps Premium Connection

- Per Connection, Fixed Mode

1,000.00 2,430.00 MTEP6

- Per Connection, Burst Mode

1,000.00 2,724.30 MTEE6

(h) 250 Mbps Premium Connection

- Per Connection, Fixed Mode

1,000.00 3,034.80 MTEP7

- Per Connection, Burst Mode

1,000.00 3,260.25 MTEE7

(i) 500 Mbps Premium Connection

- Per Connection, Fixed Mode

1,000.00 4,039.20 MTEP8

- Per Connection, Burst Mode

1,000.00 4,182.30 MTEE8

(j) 900 Mbps Premium Connection

- Per Connection, Fixed Mode

1,500.00 5,988.60 MTEP9

3.

Note 1: Effective on or after August 22, 2021, this Service will no longer be available for purchase by new or existing customers. In addition, requests to move, add, change, or renew existing service arrangements will not be accepted. Following the expiration of a customer's existing term agreement, service will be provided on a month-to-month basis at the applicable Monthly rates until the service is discontinued. The Company currently plans to discontinue this service on or after March 31, 2023.

E7. SPECIAL ACCESS (A.K.A. BELLSOUTH SPA) SERVICE

E7.5 Rates and Charges (Cont'd)

E7.5.22 BellSouth Metro Ethernet Service (Cont'd)²

A. Rates and charges for month-to-month service (Cont'd)

4. Virtual BellSouth Metro Ethernet Service Arrangements¹

(a) 2 Mbps Virtual Connection

- Per Connection

(b) 4 Mbps Virtual Connection

- Per Connection

(c) 8 Mbps Virtual Connection

- Per Connection

(d) 10 Mbps Virtual Connection

- Per Connection

(e) 20 Mbps Virtual Connection

- Per Connection

(f) 50 Mbps Virtual Connection

- Per Connection

(g) 80 Mbps Virtual Connection

- Per Connection

(h) 100 Mbps Virtual Connection

- Per Connection

(i) 200 Mbps Virtual Connection

- Per Connection

(j) 300 Mbps Virtual Connection

- Per Connection

(k) 450 Mbps Virtual Connection

- Per Connection

(l) 600 Mbps Virtual Connection

- Per Connection

(m) 750 Mbps Virtual Connection

- Per Connection

(n) 900 Mbps Virtual Connection

- Per Connection

	Nonrecurring Charge	Month to Month	USOC
	\$ 1,000.00	\$ 523.80	MTEVO
	1,000.00	561.60	MTEV1
	1,000.00	680.40	MTEV2
	1,000.00	1,004.40	MTEV3
	1,000.00	1,306.80	MTEV4
	1,000.00	1,792.80	MTEV5
	1,000.00	2,003.40	MTEV6
	1,500.00	2,214.00	MTEV7
	1,500.00	2,818.80	MTEV8
	1,500.00	3,180.60	MTEV9
	1,500.00	3,823.20	MTEVA
	1,750.00	4,541.40	MTEVB
	1,750.00	5,292.00	MTEVC
	2,000.00	5,772.60	MTEVD
5. BellSouth Metro Ethernet Service Independent Company (ICO) Trunk Arrangements			
(a) ICO Trunk Connection			
- Per VLAN Connection	1,300.00	1,046.25	MTEGC

Note 1: Each Virtual Connection requires the establishment of a Class of Service (CoS) profile.

Note 2: Effective on or after August 22, 2021, this Service will no longer be available for purchase by new or existing customers. In addition, requests to move, add, change, or renew existing service arrangements will not be accepted. Following the expiration of a customer's existing term agreement, service will be provided on a month-to-month basis at the applicable Monthly rates until the service is discontinued. The Company currently plans to discontinue this service on or after March 31, 2023.

(1)

E7. SPECIAL ACCESS (A.K.A. BELLSOUTH SPA) SERVICE

E7.5 Rates and Charges (Cont'd)

E7.5.22 BellSouth Metro Ethernet Service (Cont'd)¹

A. Rates and charges for month-to-month service (Cont'd)

6. BellSouth Metro Ethernet Service Additional Mileage

- (a) BellSouth Metro Ethernet Service Additional Mileage:
BellSouth Metro Ethernet Service arrangements greater than 10 miles through 25 airline miles

	Month to Month	USOC
- Per 2 – 9 Mbps Connection	\$ 432.00	MTEMO
- Per 10 – 99 Mbps Connection	449.55	MTEMA
- Per 100 – 499 Mbps Connection	558.90	MTEMB
- Per 500 Mbps – 1 Gbps Connection	680.40	MTEMC

- (b) BellSouth Metro Ethernet Service Additional Mileage:
BellSouth Metro Ethernet Service arrangements greater than 25 miles through 35 airline miles

- Per 2 – 9 Mbps Connection	708.75	MTEMD
- Per 10 – 99 Mbps Connection	753.30	MTEME
- Per 100 – 499 Mbps Connection	947.70	MTEMF
- Per 500 Mbps – 1 Gbps Connection	1,129.95	MTEMG

- (c) BellSouth Metro Ethernet Service Additional Mileage:
BellSouth Metro Ethernet Service arrangements greater than 35 miles through 50 airline miles

- Per 2 – 9 Mbps Connection	1,080.00	MTEMH
- Per 10 – 99 Mbps Connection	1,178.55	MTEMJ
- Per 100 – 499 Mbps Connection	1,470.15	MTEMK
- Per 500 Mbps – 1 Gbps Connection	1,773.90	MTEML

7. BellSouth Metro Ethernet Service Independent Company (ICO) Trunk Additional Mileage Charges

- (a) BellSouth Metro Ethernet Service ICO Trunk Additional Mileage:
BellSouth Metro Ethernet Service ICO Trunk arrangements greater than 10 miles through 25 airline miles
- per VLAN Connection

229.50	MTEMI
--------	-------

- (b) BellSouth Metro Ethernet Service ICO Trunk Additional Mileage:
BellSouth Metro Ethernet Service ICO Trunk arrangements greater than 25 miles through 35 airline miles
- per VLAN Connection

567.00	MTEM2
--------	-------

- (c) BellSouth Metro Ethernet Service ICO Trunk Additional Mileage:
BellSouth Metro Ethernet Service ICO Trunk arrangements greater than 35 miles through 50 airline miles
- per VLAN Connection

911.25	MTEM3
--------	-------

Note 1: Effective on or after August 22, 2021, this Service will no longer be available for purchase by new or existing customers. In addition, requests to move, add, change, or renew existing service arrangements will not be accepted. Following the expiration of a customer's existing term agreement, service will be provided on a month-to-month basis at the applicable Monthly rates until the service is discontinued. The Company currently plans to discontinue this service on or after March 31, 2023.

(1) (1) (1) (1) (1) (1) (1) (1) (1) (1)

E7. SPECIAL ACCESS (A.K.A. BELLSOUTH SPA) SERVICE

E7.5 Rates and Charges (Cont'd)

E7.5.22 BellSouth Metro Ethernet Service (Cont'd)⁵

A. Rates and charges for month-to-month service (Cont'd)

8. Priority Plus Feature¹

	Nonrecurring Charge	Month to Month	USOC	(1)
- Per Connection	\$ -	\$ 162.00	MTEP	
9. Q-Forwarding Feature ¹				
(a) Q-Forwarding Service Establishment Charge	400.00	-	MTEQF	
- Per Connection				
(b) Q-Forwarding Network Assignment Charge	-	108.00	MTEQN	(1)
- Per Network, Per Connection				
10. VLAN Aggregation Feature ²				
(a) VLAN Aggregation Service Establishment Charge	400.00	-	MTEQE	
- Per Connection				
(b) VLAN Aggregation Network Assignment Charge	-	108.00	MTEQV	(1)
- Per VLAN, Per Connection				
11. CNM - Metro Ethernet Reporting Feature ³				
(a) CNM - Metro Ethernet Reporting, Service Establishment Charge	225.00	-	MTERE	
- Per Customer Account				
(b) CNM - Metro Ethernet Reporting Charge	-	13.50	MTERC	(1)
- Per Connection				
(c) CNM - Metro Ethernet Reporting, Web Interface Charge	-	-	MTER1	
- First	65.00	27.00	MTERW	(1)
- Each Additional				
(d) CNM - Metro Ethernet Reporting, Security Card ⁴	200.00	-	MTERS	
- Each				

Note 1: Optional feature only available with a Premium Connection.

Note 2: Optional feature only available with a Virtual Connection.

Note 3: Optional feature only available with a Premium or Virtual Connection.

Note 4: Effective November 1, 2008, this option is no longer available for new customer subscriptions as set forth in E7.2.18.

Note 5: Effective on or after August 22, 2021, this Service will no longer be available for purchase by new or existing customers. In addition, requests to move, add, change, or renew existing service arrangements will not be accepted. Following the expiration of a customer's existing term agreement, service will be provided on a month-to-month basis at the applicable Monthly rates until the service is discontinued. The Company currently plans to discontinue this service on or after March 31, 2023.

E7. SPECIAL ACCESS (A.K.A. BELL SOUTH SPA) SERVICE

E7.5 Rates and Charges (Cont'd)

E7.5.22 BellSouth Metro Ethernet Service (Cont'd)³

A. Rates and charges for month-to-month service (Cont'd)

12. Class of Service (CoS) Profile¹

(a) Real-Time CoS²

	Month to Month	USOC
- 10%	\$ 72.90	MTETF
- 20%	145.80	MTETG
- 25%	182.25	MTETH
- 30%	218.70	MTETJ
- 35%	255.15	MTETK
- 40%	291.60	MTETL
- 50%	364.50	MTETM
- 70%	510.30	MTETO

(b) Interactive CoS²

- 10%	60.75	MTEVF
- 20%	121.50	MTEVG
- 25%	151.20	MTEVH
- 30%	182.25	MTEVJ
- 35%	211.95	MTEVK
- 40%	243.00	MTEVL
- 50%	303.75	MTEVM

Note 1: Each Virtual Connection requires the designation of a CoS profile with desired percentages of each CoS selected. The sum of the percentages for all CoS selected for a Virtual Connection must sum to 100%.

Note 2: The combined CoS bandwidth percentages selected in a customer's Virtual Connection CoS profile for Real-Time CoS plus Interactive CoS may not exceed 50%, except where the customer selects the 70% Real-Time CoS bandwidth percentage and has no Interactive traffic.

Note 3: Effective on or after August 22, 2021, this Service will no longer be available for purchase by new or existing customers. In addition, requests to move, add, change, or renew existing service arrangements will not be accepted. Following the expiration of a customer's existing term agreement, service will be provided on a month-to-month basis at the applicable Monthly rates until the service is discontinued. The Company currently plans to discontinue this service on or after March 31, 2023.

(1)

E7. SPECIAL ACCESS (A.K.A. BELLSOUTH SPA) SERVICE

E7.5 Rates and Charges (Cont'd)

E7.5.22 BellSouth Metro Ethernet Service (Cont'd)²

A. Rates and charges for month-to-month service (Cont'd)

12. Class of Service (CoS) Profile¹ (Cont'd)

(c) Business Critical CoS

	Month to Month	USOC
- 10%	\$ 36.45	MTEPF
- 20%	72.90	MTEPG
- 25%	90.45	MTEPH
- 30%	109.35	MTEPJ
- 35%	126.90	MTEPK
- 40%	145.80	MTEPL
- 50%	182.25	MTEPM
- 60%	218.70	MTEPN
- 75%	272.70	MTEPP
- 90%	328.05	MTEPQ
- 100%	364.50	MTEPR

(d) Best Effort CoS

- 10%	12.15	MTEBF
- 20%	24.30	MTEBG
- 25%	29.70	MTEBH
- 30%	36.45	MTEBJ
- 35%	41.85	MTEBK
- 40%	48.60	MTEBL
- 50%	60.75	MTEBM
- 60%	72.90	MTEBN
- 75%	90.45	MTEBP
- 90%	109.35	MTEBQ

Note 1: Each Virtual Connection requires the designation of a CoS profile with desired percentages of each CoS selected. The sum of the percentages for all CoS selected for a Virtual Connection must sum to 100%.

Note 2: Effective on or after August 22, 2021, this Service will no longer be available for purchase by new or existing customers. In addition, requests to move, add, change, or renew existing service arrangements will not be accepted. Following the expiration of a customer's existing term agreement, service will be provided on a month-to-month basis at the applicable Monthly rates until the service is discontinued. The Company currently plans to discontinue this service on or after March 31, 2023.

(1)

E7. SPECIAL ACCESS (A.K.A. BELLSOUTH SPA) SERVICE

E7.5 Rates and Charges (Cont'd)

E7.5.22 BellSouth Metro Ethernet Service (Cont'd)³

A. Rates and charges for month-to-month service (Cont'd)

13. Automatic Protection Switching (APS) Feature¹: Selected to provide automatic protection switching in conjunction with a Basic, Premium or Virtual BellSouth Metro Ethernet Connection of 10 Mbps or higher. Applicable APS rate element based upon type of APS selected and actual total route miles² (rounded up to next whole mile) based upon a customer-specific design as determined by the Telephone Company.

(a) Structural Protection

	Nonrecurring Charge	Month to Month	USOC
- Per APS Arrangement of less than 10 route miles	\$ 1000.00	\$ 2,565.00	MTEAO
- Per APS Arrangement of 10 through 25 route miles	1500.00	2,895.75	MTEA1
- Per APS Arrangement of greater than 25 through 35 route miles	2000.00	3,300.75	MTEA2
- Per APS Arrangement of greater than 35 through 50 route miles	2500.00	3,915.00	MTEA3

(b) Route Protection

- Per APS Arrangement of less than 10 route miles	1500.00	3,132.00	MTEA5
- Per APS Arrangement of 10 through 25 route miles	2000.00	3,523.50	MTEA6
- Per APS Arrangement of greater than 25 through 35 route miles	2500.00	4,002.75	MTEA7
- Per APS Arrangement of greater than 35 through 50 route miles	3000.00	4,637.25	MTEA8

14. Optical Termination Charge: An electrical termination on the customer premises is standard for 2, 4 and 8 Mbps Basic, Premium and Virtual Connections. Therefore, an Optical Termination Charge applies when an optional optical termination is requested and provided for a 2, 4 or 8 Mbps Connection.

(a) Per Optical Termination

- Per Connection	-	40.50	MTEO1
------------------	---	-------	-------

15. Service Reconfiguration Charge

(a) Per Request

- Per Connection	200.00	-	MTESR
------------------	--------	---	-------

16. System Reconfiguration Charge

(a) Per Request

- Per Connection	900.00	-	MTESY
------------------	--------	---	-------

Note 1: Optional feature only available with a Basic, Premium or Virtual Connection of 10 Mbps or higher. (APS is not available for a 2 Mbps, 4 Mbps or 8 Mbps Basic, Premium or Virtual Connection).

Note 2: Per definition of route mileage provided in E7.2.18U preceding.

Note 3: Effective on or after August 22, 2021, this Service will no longer be available for purchase by new or existing customers. In addition, requests to move, add, change, or renew existing service arrangements will not be accepted. Following the expiration of a customer's existing term agreement, service will be provided on a month-to-month basis at the applicable Monthly rates until the service is discontinued. The Company currently plans to discontinue this service on or after March 31, 2023.

E7. SPECIAL ACCESS (A.K.A. BELL SOUTH SPA) SERVICE

E7.5 Rates and Charges (Cont'd)

E7.5.22 BellSouth Metro Ethernet Service (Cont'd)²

(C)

- B. Rates and charges for Transport Payment Plan
 - 1. Basic BellSouth Metro Ethernet Service Arrangements
 - (a) 2 Mbps Basic Connection

		Transport Payment Plan Rates				
		Nonrecurring Charge	A 12-36 Mos	B 37-60 Mos¹	C 61-96 Mos¹	
		\$	\$	\$	\$	
	- Per Connection	-	380.00	360.00	345.00	USOC MTEBO
(b)	4 Mbps Basic Connection					
	- Per Connection	-	500.00	415.00	395.00	MTEB1
(c)	8 Mbps Basic Connection					
	- Per Connection	-	540.00	475.00	450.00	MTEB2
(d)	10 Mbps Basic Connection					
	- Per Connection	-	630.00	599.00	550.00	MTEBA
(e)	100 Mbps Basic Connection					
	- Per Connection	-	1,180.00	1,121.00	1,065.00	MTEBB
(f)	1 Gbps Basic Connection					
	- Per Connection	-	2,565.00	2,437.00	2,315.00	MTEBC
2. Premium BellSouth Metro Ethernet Service Arrangements						
(a)	2 Mbps Premium Connection					
	- Per Connection, Fixed Mode	-	500.00	435.00	415.00	MTEPO
(b)	4 Mbps Premium Connection					
	- Per Connection, Fixed Mode	-	540.00	470.00	445.00	MTEP1
(c)	8 Mbps Premium Connection					
	- Per Connection, Fixed Mode	-	640.00	510.00	485.00	MTEP2
(d)	10 Mbps Premium Connection					
	- Per Connection, Fixed Mode	-	720.00	684.00	650.00	MTEP3
	- Per Connection, Burst Mode	-	900.00	855.00	812.00	MTEE3
(e)	20 Mbps Premium Connection					
	- Per Connection, Fixed Mode	-	904.00	859.00	816.00	MTEP4
	- Per Connection, Burst Mode	-	1,013.00	962.00	914.00	MTEE4
(f)	50 Mbps Premium Connection					
	- Per Connection, Fixed Mode	-	1,192.00	1,132.00	1,075.00	MTEP5
	- Per Connection, Burst Mode	-	1,238.00	1,176.00	1,117.00	MTEE5
(g)	100 Mbps Premium Connection					
	- Per Connection, Fixed Mode	-	1,440.00	1,368.00	1,300.00	MTEP6
	- Per Connection, Burst Mode	-	1,613.00	1,532.00	1,455.00	MTEE6
(h)	250 Mbps Premium Connection					
	- Per Connection, Fixed Mode	-	1,800.00	1,710.00	1,625.00	MTEP7
	- Per Connection, Burst Mode	-	1,935.00	1,838.00	1,746.00	MTEE7
(i)	500 Mbps Premium Connection					
	- Per Connection, Fixed Mode	-	2,392.00	2,272.00	2,158.00	MTEP8
	- Per Connection, Burst Mode	-	2,475.00	2,351.00	2,233.00	MTEE8
(j)	900 Mbps Premium Connection					
	- Per Connection, Fixed Mode	-	3,700.00	3,532.00	3,356.00	MTEP9
3. (DELETED)						

Note 1: All term plans for BellSouth Metro Ethernet Service which are established, renewed or extended after December 10, 2013, for term lengths which are scheduled to expire at any time after October 1, 2018, will instead expire on October 1, 2018. All such services existing on or after October 1, 2018, will be provided on a month-to-month basis at the applicable, then current month-to-month rates. Notwithstanding anything to the contrary in the previous two sentences, this footnote does not apply to any term plans established, renewed or extended after November 5, 2016.

(T)

Note 2: Effective on or after August 22, 2021, this Service will no longer be available for purchase by new or existing customers. In addition, requests to move, add, change, or renew existing service arrangements will not be accepted. Following the expiration of a customer's existing term agreement, service will be provided on a month-to-month basis at the applicable Monthly rates until the service is discontinued. The Company currently plans to discontinue this service on or after March 31, 2023.

(N)

(N)

E7. SPECIAL ACCESS (A.K.A. BELLSOUTH SPA) SERVICE

E7.5 Rates and Charges (Cont'd)

E7.5.22 BellSouth Metro Ethernet Service (Cont'd)³

(C)

B. Rates and charges for Transport Payment Plan (Cont'd)

4. Virtual BellSouth Metro Ethernet Service Arrangements¹

(a) 2 Mbps Virtual Connection

	Nonrecurring Charge	Transport Payment Plan Rates			USOC MTEVO
		A 12-36 Mos	B 37-60 Mos ²	C 61-96 Mos ²	
- Per Connection	\$ -	\$ 340.00	\$ 321.00	\$ 305.00	MTEV0
(b) 4 Mbps Virtual Connection					
- Per Connection	-	380.00	359.00	341.00	MTEV1
(c) 8 Mbps Virtual Connection					
- Per Connection	-	480.00	454.00	431.00	MTEV2
(d) 10 Mbps Virtual Connection					
- Per Connection	-	560.00	529.00	503.00	MTEV3
(e) 20 Mbps Virtual Connection					
- Per Connection	-	744.00	703.00	668.00	MTEV4
(f) 50 Mbps Virtual Connection					
- Per Connection	-	1,032.00	975.00	926.00	MTEV5
(g) 80 Mbps Virtual Connection					
- Per Connection	-	1,156.00	1,092.00	1,038.00	MTEV6
(h) 100 Mbps Virtual Connection					
- Per Connection	-	1,280.00	1,210.00	1,149.00	MTEV7
(i) 200 Mbps Virtual Connection					
- Per Connection	-	1,640.00	1,550.00	1,472.00	MTEV8
(j) 300 Mbps Virtual Connection					
- Per Connection	-	1,936.00	1,830.00	1,738.00	MTEV9
(k) 450 Mbps Virtual Connection					
- Per Connection	-	2,232.00	2,109.00	2,004.00	MTEVA
(l) 600 Mbps Virtual Connection					
- Per Connection	-	2,660.00	2,514.00	2,388.00	MTEVB
(m) 750 Mbps Virtual Connection					
- Per Connection	-	3,104.00	2,933.00	2,787.00	MTEVC
(n) 900 Mbps Virtual Connection					
- Per Connection	-	3,540.00	3,345.00	3,178.00	MTEVD

5. BellSouth Metro Ethernet Service Independent Company (ICO) Trunk Arrangements

(a) ICO Trunk Connection

- Per VLAN Connection	-	500.00	450.00	405.00	MTEGC
-----------------------	---	--------	--------	--------	-------

Note 1: Each Virtual Connection requires the establishment of a Class of Service (CoS) profile.

Note 2: All term plans for BellSouth Metro Ethernet Service which are established, renewed or extended after December 10, 2013, for term lengths which are scheduled to expire at any time after October 1, 2018, will instead expire on October 1, 2018. All such services existing on or after October 1, 2018, will be provided on a month-to-month basis at the applicable, then current month-to-month rates. Notwithstanding anything to the contrary in the previous two sentences, this footnote does not apply to any term plans established, renewed or extended after November 5, 2016.

Note 3: Effective on or after August 22, 2021, this Service will no longer be available for purchase by new or existing customers. In addition, requests to move, add, change, or renew existing service arrangements will not be accepted. Following the expiration of a customer's existing term agreement, service will be provided on a month-to-month basis at the applicable Monthly rates until the service is discontinued. The Company currently plans to discontinue this service on or after March 31, 2023.

(N)
|
(N)

E7. SPECIAL ACCESS (A.K.A. BELL SOUTH SPA) SERVICE

E7.5 Rates and Charges (Cont'd)

E7.5.22 BellSouth Metro Ethernet Service (Cont'd)²

(C)

B. Rates and charges for Transport Payment Plan (Cont'd)

6. BellSouth Metro Ethernet Service Additional Mileage

- (a) BellSouth Metro Ethernet Service Additional Mileage:
BellSouth Metro Ethernet Service arrangements greater than 10 miles through 25 airline miles

	Transport Payment Plan Rates				
	A	B	C		
Nonrecurring Charge	12-36 Mos	37-60 Mos¹	61-96 Mos¹		USOC
- Per 2 – 9 Mbps Connection	\$ - \$ 320.00	\$ 320.00	\$ 320.00		MTEMO
- Per 10 – 99 Mbps Connection	-	333.00	333.00		MTEMA
- Per 100 – 499 Mbps Connection	-	414.00	414.00		MTEMB
- Per 500 Mbps – 1 Gbps Connection	-	504.00	504.00		MTEMC

- (b) BellSouth Metro Ethernet Service Additional Mileage:
BellSouth Metro Ethernet Service arrangements greater than 25 miles through 35 airline miles

- Per 2 – 9 Mbps Connection	-	525.00	525.00	525.00	MTEMD
- Per 10 – 99 Mbps Connection	-	558.00	558.00	558.00	MTEME
- Per 100 – 499 Mbps Connection	-	702.00	702.00	702.00	MTEMF
- Per 500 Mbps – 1 Gbps Connection	-	837.00	837.00	837.00	MTEMG

- (c) BellSouth Metro Ethernet Service Additional Mileage:
BellSouth Metro Ethernet Service arrangements greater than 35 miles through 50 airline miles

- Per 2 – 9 Mbps Connection	-	800.00	800.00	800.00	MTEMH
- Per 10 – 99 Mbps Connection	-	873.00	873.00	873.00	MTEMJ
- Per 100 – 499 Mbps Connection	-	1,089.00	1,089.00	1,089.00	MTEMK
- Per 500 Mbps – 1 Gbps Connection	-	1,314.00	1,314.00	1,314.00	MTEML

7. BellSouth Metro Ethernet Service Independent Company (ICO) Trunk Additional Mileage Charges

- (a) BellSouth Metro Ethernet Service ICO Trunk Additional Mileage:
BellSouth Metro Ethernet Service ICO Trunk arrangements greater than 10 miles through 25 airline miles

- per VLAN Connection	-	170.00	170.00	170.00	MTEMI1
-----------------------	---	--------	--------	--------	--------

- (b) BellSouth Metro Ethernet Service ICO Trunk Additional Mileage:
BellSouth Metro Ethernet Service ICO Trunk arrangements greater than 25 miles through 35 airline miles

- per VLAN Connection	-	420.00	420.00	420.00	MTEMI2
-----------------------	---	--------	--------	--------	--------

- (c) BellSouth Metro Ethernet Service ICO Trunk Additional Mileage:
BellSouth Metro Ethernet Service ICO Trunk arrangements greater than 35 miles through 50 airline miles

- per VLAN Connection	-	675.00	675.00	675.00	MTEMI3
-----------------------	---	--------	--------	--------	--------

Note 1: All term plans for BellSouth Metro Ethernet Service which are established, renewed or extended after December 10, 2013, for term lengths which are scheduled to expire at any time after October 1, 2018, will instead expire on October 1, 2018. All such services existing on or after October 1, 2018, will be provided on a month-to-month basis at the applicable, then current month-to-month rates. Notwithstanding anything to the contrary in the previous two sentences, this footnote does not apply to any term plans established, renewed or extended after November 5, 2016.

Note 2: Effective on or after August 22, 2021, this Service will no longer be available for purchase by new or existing customers. In addition, requests to move, add, change, or renew existing service arrangements will not be accepted. Following the expiration of a customer's existing term agreement, service will be provided on a month-to-month basis at the applicable Monthly rates until the service is discontinued. The Company currently plans to discontinue this service on or after March 31, 2023.

(N)
|
(N)

E7. SPECIAL ACCESS (A.K.A. BELLSOUTH SPA) SERVICE

E7.5 Rates and Charges (Cont'd)

E7.5.22 BellSouth Metro Ethernet Service (Cont'd)⁵

(C)

B. Rates and charges for Transport Payment Plan (Cont'd)

8. Priority Plus Feature¹

Transport Payment Plan Rates					
	A	B	C		
Nonrecurring Charge²	12-36	37-60	61-96		
	Mos	Mos⁴	Mos⁴		
- Per Connection	\$ -	\$ 95.00	\$ 85.00	\$ 80.00	USOC MTETP

9. Q-Forwarding Feature¹

(a) Q-Forwarding Service Establishment Charge

- Per Connection	Nonrecurring Charge²	\$400.00	USOC MTEQF		
------------------	----------------------------------------	-----------------	-----------------------	--	--

(b) Q-Forwarding Network Assignment Charge

Transport Payment Plan Rates					
	A	B	C		
Nonrecurring Charge²	12-36	37-60	61-96		
	Mos	Mos⁴	Mos⁴		
- Per Network, Per Connection	\$ -	\$ 65.00	\$ 60.00	\$ 55.00	USOC MTEQN

10. VLAN Aggregation Feature³

(a) VLAN Aggregation Service Establishment Charge

- Per Connection	Nonrecurring Charge²	\$400.00	USOC MTEQE		
------------------	----------------------------------------	-----------------	-----------------------	--	--

(b) VLAN Aggregation Network Assignment Charge

Transport Payment Plan Rates					
	A	B	C		
Nonrecurring Charge²	12-36	37-60	61-96		
	Mos	Mos⁴	Mos⁴		
- Per VLAN, Per Connection	\$ -	\$ 65.00	\$ 60.00	\$ 55.00	USOC MTEQV

Note 1: Optional feature only available with a Premium Connection.

Note 2: This nonrecurring charge is applicable to service under a TPP arrangement.

Note 3: Optional feature only available with a Virtual Connection.

Note 4: All term plans for BellSouth Metro Ethernet Service which are established, renewed or extended after December 10, 2013, for term lengths which are scheduled to expire at any time after October 1, 2018, will instead expire on October 1, 2018. All such services existing on or after October 1, 2018, will be provided on a month-to-month basis at the applicable, then current month-to-month rates. Notwithstanding anything to the contrary in the previous two sentences, this footnote does not apply to any term plans established, renewed or extended after November 5, 2016.

Note 5: Effective on or after August 22, 2021, this Service will no longer be available for purchase by new or existing customers. In addition, requests to move, add, change, or renew existing service arrangements will not be accepted. Following the expiration of a customer's existing term agreement, service will be provided on a month-to-month basis at the applicable Monthly rates until the service is discontinued. The Company currently plans to discontinue this service on or after March 31, 2023.

(N)
|
(N)

E7. SPECIAL ACCESS (A.K.A. BELLSOUTH SPA) SERVICE

E7.5 Rates and Charges (Cont'd)

E7.5.22 BellSouth Metro Ethernet Service (Cont'd)⁵

(C)

B. Rates and charges for Transport Payment Plan (Cont'd)

11. CNM - Metro Ethernet Reporting Feature¹

- (a) CNM - Metro Ethernet Reporting, Service Establishment Charge

Nonrecurring Charge²
\$ 225.00 **USOC**
MTERE

- Per Customer Account

- (b) CNM - Metro Ethernet Reporting Charge

Transport Payment Plan Rates

	A	B	C	
Nonrecurring Charge²	12-36 Mos	37-60 Mos⁴	61-96 Mos⁴	USOC
\$ -	\$ 8.00	\$ 6.00	\$ 5.00	MTERC

- Per Connection

- (c) CNM - Metro Ethernet Reporting, Web Interface Charge

- First

- Each Additional

-	-	-	-	MTER1
65.00	18.00	15.00	13.00	MTERW

- (d) CNM - Metro Ethernet Reporting, Security Card³

- Each

Nonrecurring Charge
\$ 200.00 **USOC**
MTERS

Note 1: Optional feature only available with a Premium or Virtual Connection.

Note 2: This nonrecurring charge is applicable to service under a TPP arrangement.

Note 3: Effective November 1, 2008, this option is no longer available for new customer subscriptions as set forth in E7.2.18.

Note 4: All term plans for BellSouth Metro Ethernet Service which are established, renewed or extended after December 10, 2013, for term lengths which are scheduled to expire at any time after October 1, 2018, will instead expire on October 1, 2018. All such services existing on or after October 1, 2018, will be provided on a month-to-month basis at the applicable, then current month-to-month rates. Notwithstanding anything to the contrary in the previous two sentences, this footnote does not apply to any term plans established, renewed or extended after November 5, 2016.

Note 5: Effective on or after August 22, 2021, this Service will no longer be available for purchase by new or existing customers. In addition, requests to move, add, change, or renew existing service arrangements will not be accepted. Following the expiration of a customer's existing term agreement, service will be provided on a month-to-month basis at the applicable Monthly rates until the service is discontinued. The Company currently plans to discontinue this service on or after March 31, 2023.

(N)
 |
 (N)

E7. SPECIAL ACCESS (A.K.A. BELL SOUTH SPA) SERVICE

E7.5 Rates and Charges (Cont'd)

E7.5.22 BellSouth Metro Ethernet Service (Cont'd)⁵

(C)

B. Rates and charges for Transport Payment Plan (Cont'd)

12. Class of Service (CoS) Profile¹

(a) Real-Time CoS²

	Transport Payment Plan Rates				USOC
	Nonrecurring Charge ³	A 12-36 Mos	B 37-60 Mos ⁴	C 61-96 Mos ⁴	
- 10%	\$ -	\$ 54.00	\$ 54.00	\$ 54.00	MTETF
- 20%	-	108.00	108.00	108.00	MTETG
- 25%	-	135.00	135.00	135.00	MTETH
- 30%	-	162.00	162.00	162.00	MTETJ
- 35%	-	189.00	189.00	189.00	MTETK
- 40%	-	216.00	216.00	216.00	MTETL
- 50%	-	270.00	270.00	270.00	MTETM
- 70%	-	378.00	378.00	378.00	MTETO

(b) Interactive CoS²

- 10%	-	45.00	45.00	45.00	MTEVF
- 20%	-	90.00	90.00	90.00	MTEVG
- 25%	-	112.00	112.00	112.00	MTEVH
- 30%	-	135.00	135.00	135.00	MTEVJ
- 35%	-	157.00	157.00	157.00	MTEVK
- 40%	-	180.00	180.00	180.00	MTEVL
- 50%	-	225.00	225.00	225.00	MTEVM

Note 1: Each Virtual Connection requires the designation of a CoS profile with desired percentages of each CoS selected. The sum of the percentages for all CoS selected for a Virtual Connection must sum to 100%..

Note 2: The combined CoS bandwidth percentages selected in a customer’s Virtual Connection CoS profile for Real-Time CoS plus Interactive CoS may not exceed 50%, except where the customer selects the 70% Real-Time CoS bandwidth percentage and has no Interactive traffic.

Note 3: This nonrecurring charge is applicable to service under a TPP Arrangement.

Note 4: All term plans for BellSouth Metro Ethernet Service which are established, renewed or extended after December 10, 2013, for term lengths which are scheduled to expire at any time after October 1, 2018, will instead expire on October 1, 2018. All such services existing on or after October 1, 2018, will be provided on a month-to-month basis at the applicable, then current month-to-month rates. Notwithstanding anything to the contrary in the previous two sentences, this footnote does not apply to any term plans established, renewed or extended after November 5, 2016.

Note 5: Effective on or after August 22, 2021, this Service will no longer be available for purchase by new or existing customers. In addition, requests to move, add, change, or renew existing service arrangements will not be accepted. Following the expiration of a customer's existing term agreement, service will be provided on a month-to-month basis at the applicable Monthly rates until the service is discontinued. The Company currently plans to discontinue this service on or after March 31, 2023.

(N)
|
(N)

E7. SPECIAL ACCESS (A.K.A. BELL SOUTH SPA) SERVICE

E7.5 Rates and Charges (Cont'd)

E7.5.22 BellSouth Metro Ethernet Service (Cont'd)⁴

(C)

B. Rates and charges for Transport Payment Plan (Cont'd)

12. Class of Service (CoS) Profile¹ (Cont'd)

(c) Business Critical CoS

	Transport Payment Plan Rates				USOC
	Nonrecurring Charge ²	A	B	C	
		12-36 Mos	37-60 Mos ³	61-96 Mos ³	
- 10%	\$ -	\$ 27.00	\$ 27.00	\$ 27.00	MTEPF
- 20%	-	54.00	54.00	54.00	MTEPG
- 25%	-	67.00	67.00	67.00	MTEPH
- 30%	-	81.00	81.00	81.00	MTEPJ
- 35%	-	94.00	94.00	94.00	MTEPK
- 40%	-	108.00	108.00	108.00	MTEPL
- 50%	-	135.00	135.00	135.00	MTEPM
- 60%	-	162.00	162.00	162.00	MTEPN
- 75%	-	202.00	202.00	202.00	MTEPP
- 90%	-	243.00	243.00	243.00	MTEPQ
- 100%	-	270.00	270.00	270.00	MTEPR

(d) Best Effort CoS

- 10%	-	9.00	9.00	9.00	MTEBF
- 20%	-	18.00	18.00	18.00	MTEBG
- 25%	-	22.00	22.00	22.00	MTEBH
- 30%	-	27.00	27.00	27.00	MTEBJ
- 35%	-	31.00	31.00	31.00	MTEBK
- 40%	-	36.00	36.00	36.00	MTEBL
- 50%	-	45.00	45.00	45.00	MTEBM
- 60%	-	54.00	54.00	54.00	MTEBN
- 75%	-	67.00	67.00	67.00	MTEBP
- 90%	-	81.00	81.00	81.00	MTEBQ

Note 1: Each Virtual Connection requires the designation of a CoS profile with desired percentages of each CoS selected. The sum of the percentages for all CoS selected for a Virtual Connection must sum to 100%..

Note 2: This nonrecurring charge is applicable to service under a TPP Arrangement.

Note 3: All term plans for BellSouth Metro Ethernet Service which are established, renewed or extended after December 10, 2013, for term lengths which are scheduled to expire at any time after October 1, 2018, will instead expire on October 1, 2018. All such services existing on or after October 1, 2018, will be provided on a month-to-month basis at the applicable, then current month-to-month rates. Notwithstanding anything to the contrary in the previous two sentences, this footnote does not apply to any term plans established, renewed or extended after November 5, 2016.

Note 4: Effective on or after August 22, 2021, this Service will no longer be available for purchase by new or existing customers. In addition, requests to move, add, change, or renew existing service arrangements will not be accepted. Following the expiration of a customer's existing term agreement, service will be provided on a month-to-month basis at the applicable Monthly rates until the service is discontinued. The Company currently plans to discontinue this service on or after March 31, 2023.

(N)

(N)

E7. SPECIAL ACCESS (A.K.A. BELL SOUTH SPA) SERVICE

E7.5 Rates and Charges (Cont'd)

E7.5.22 BellSouth Metro Ethernet Service (Cont'd)⁵

(C)

B. Rates and charges for Transport Payment Plan (Cont'd)

13. Automatic Protection Switching (APS) Feature¹: Selected to provide automatic protection switching in conjunction with a Basic, Premium or Virtual BellSouth Metro Ethernet Connection of 10 Mbps or higher. Applicable APS rate element based upon type of APS selected and actual total route miles² (rounded up to next whole mile) based upon a customer-specific design as determined by the Telephone Company.

(a) Structural Protection

	Transport Payment Plan Rates				USOC
	Nonrecurring Charge³	A 12-36 Mos	B 37-60 Mos⁴	C 61-96 Mos⁴	
- Per APS Arrangement of less than 10 route miles	\$ -	\$ 1250.00	\$ 1092.00	\$ 935.00	MTEAO
- Per APS Arrangement of 10 through 25 route miles	-	1496.00	1301.00	1126.00	MTEA1
- Per APS Arrangement of greater than 25 through 35 route miles	-	1798.00	1679.00	1530.00	MTEA2
- Per APS Arrangement of greater than 35 through 50 route miles	-	2452.00	2376.00	2134.00	MTEA3

(b) Route Protection

- Per APS Arrangement of less than 10 route miles	-	1470.00	1285.00	1100.00	MTEA5
- Per APS Arrangement of 10 through 25 route miles	-	1760.00	1530.00	1325.00	MTEA6
- Per APS Arrangement of greater than 25 through 35 route miles	-	2115.00	1975.00	1800.00	MTEA7
- Per APS Arrangement of greater than 35 through 50 route miles	-	2885.00	2795.00	2510.00	MTEA8

14. Optical Termination Charge: An electrical termination on the customer premises is standard for 2, 4 and 8 Mbps Basic, Premium and Virtual Connections. Therefore, an Optical Termination Charge applies when an optional optical termination is requested and provided for a 2, 4 or 8 Mbps Connection.

(a) Per Optical Termination

- Per Connection	-	30.00	30.00	30.00	MTEO1
------------------	---	-------	-------	-------	-------

15. Service Reconfiguration Charge

(a) Per Request

- Per Connection		Nonrecurring Charge³		USOC	
		\$ 200.00		MTESR	

16. System Reconfiguration Charge

(a) Per Request

- Per Connection			900.00	MTESY	
------------------	--	--	---------------	--------------	--

Note 1: Optional feature only available with a Basic, Premium or Virtual Connection.

Note 2: Per definition of route mileage provided in E7.2.18U preceding.

Note 3: This nonrecurring charge is applicable to service under a TPP arrangement.

Note 4: All term plans for BellSouth Metro Ethernet Service which are established, renewed or extended after December 10, 2013, for term lengths which are scheduled to expire at any time after October 1, 2018, will instead expire on October 1, 2018. All such services existing on or after October 1, 2018, will be provided on a month-to-month basis at the applicable, then current month-to-month rates. Notwithstanding anything to the contrary in the previous two sentences, this footnote does not apply to any term plans established, renewed or extended after November 5, 2016.

Note 5: Effective on or after August 22, 2021, this Service will no longer be available for purchase by new or existing customers. In addition, requests to move, add, change, or renew existing service arrangements will not be accepted. Following the expiration of a customer's existing term agreement, service will be provided on a month-to-month basis at the applicable Monthly rates until the service is discontinued. The Company currently plans to discontinue this service on or after March 31, 2023.

(N)
|
(N)