

BELLSOUTH
 TELECOMMUNICATIONS
 FLORIDA
 ISSUED: October 10, 2014
 BY: Joe York, President -FL
 Jacksonville, Florida

ACCESS SERVICES TARIFF

Fifth Revised Page 2
 Cancels Fourth Revised Page 2
 EFFECTIVE: October 11, 2014

E7. DEDICATED ACCESS SERVICES

CONTENTS

E7.3	Channel Interface and Network Channel Codes	27.6	
E7.3.1	Glossary of Channel Interface Codes and Options	27.6	
E7.3.2	Impedance	31	
E7.3.3	Digital Hierarchy and Channel Interface Codes	32	
E7.3.4	Service Designator/Network Channel Code Conversion Table	32	
E7.4	Rate Regulations	33	
E7.4.1	Types of Rates and Charges	33	
E7.4.2	Dedicated Access Service Capable of Using the Local Exchange Network	38	
E7.4.3	Reserved for Future Use	39	
E7.4.4	Minimum Periods	39	
E7.4.5	Moves	39	
E7.4.6	Mileage Measurement	40	
E7.4.7	Facility Hubs	41	
E7.4.8	Shared Use Analog and Digital High Capacity (a.k.a. BellSouth SPA DS0 Digital Data) Services	42	
E7.4.9	Reserved for Future Use	43	
E7.4.10	Reserved for Future Use	43	
E7.4.11	Reserved for Future Use	43	
E7.4.12	FlexServ Service (a.k.a. BellSouth SPA Customer Reconfiguration)	43	
E7.4.13	Derived Data Channel (a.k.a. BellSouth SPA Derived Data Channel) Service (DDCS)	47	
E7.4.14	SMARTRing service (a.k.a. BellSouth Dedicated Ring)	47	
E7.4.15	Zone Pricing	48	
E7.4.16	Reserved for Future Use	48	(T)
E7.4.17	SMARTPath Service (a.k.a. BellSouth SPA Shared Ring)	48 .1	
E7.4.18	Reserved for Future Use	48.2	
E7.4.19	Reserved for Future Use	48.2	
E7.4.20	Reserved for Future Use	48.2	
E7.4.21	Reserved for Future Use	48.2	
E7.4.22	Reserved for Future Use	48.2	
E7.4.23	Reserved for Future Use	48.2	
E7.4.24	Reserved for Future Use	48.2	
E7.4.25	Reserved for Future Use	48.2	
E7.4.26	Reserved for Future Use	48.2	
E7.4.27	Reserved for Future Use	48.2	
E7.4.28	Reserved for Future Use	48.2	
E7.4.29	Reserved for Future Use	48.2	
E7.4.30	Reserved for Future Use	48.2	
E7.4.31	Reserved for Future Use	48.2	
E7.4.32	BellSouth Metro Ethernet service	48.3	

BELLSOUTH
 TELECOMMUNICATIONS
 FLORIDA
 ISSUED: October 10, 2014
 BY: Joe York, President -FL
 Jacksonville, Florida

ACCESS SERVICES TARIFF

Seventh Revised Page 3
 Cancels Sixth Revised Page 3

EFFECTIVE: October 11, 2014

E7. DEDICATED ACCESS SERVICES

CONTENTS

E7.5	Rates and Charges	49	
E7.5.1	Reserved for Future Use	49	
E7.5.2	Telegraph Grade (a.k.a. BellSouth SPA Telegraph) Service	49	
E7.5.3	Voice Grade (a.k.a. BellSouth SPA DS0 VG) Service	49	
E7.5.4	Reserved for Future Use	54	
E7.5.5	Digital Data Access (a.k.a. BellSouth SPA DS0 Digital Data) Service	54	
E7.5.6	High Capacity (a.k.a. BellSouth SPA High Capacity) Service	59	
E7.5.7	Digital Data Access Service (Indiantown Telephone System)	65	
E7.5.8	Reserved for Future Use	68	
E7.5.9	Reserved for Future Use	69	
E7.5.10	Reserved for Future Use	69	
E7.5.11	Reserved for Future Use	69	
E7.5.12	Reconfiguration Charges	69	
E7.5.13	Transfer of Service	69	
E7.5.14	Reserved for Future Use	69	
E7.5.15	Derived Data Channel (a.k.a. BellSouth SPA Derived Data Channel) Service	71	
E7.5.16	BellSouth FlexServ Service (a.k.a. BellSouth SPA Customer Reconfiguration)	71	
E7.5.17	BellSouth SMARTPath Service (a.k.a. BellSouth SPA Shared Ring)	73	
E7.5.18	BellSouth SMARTRingService (a.k.a. BellSouth Dedicated Ring)	74	
E7.5.19	Reserved for Future Use	77	(T)
E7.5.20	Reserved for Future Use	78	
E7.5.21	Reserved for Future Use	78	
E7.5.22	BellSouth Metro Ethernet service	78	

BELLSOUTH
TELECOMMUNICATIONS
FLORIDA
ISSUED: October 10, 2014
BY: Joe York, President -FL
Jacksonville, Florida

ACCESS SERVICES TARIFF

Fifth Revised Page 2
Cancels Fourth Revised Page 2

EFFECTIVE: October 11, 2014

E7. DEDICATED ACCESS SERVICES

CONTENTS

E7.3	Channel Interface and Network Channel Codes	27.6
E7.3.1	Glossary of Channel Interface Codes and Options	27.6
E7.3.2	Impedance	31
E7.3.3	Digital Hierarchy and Channel Interface Codes	32
E7.3.4	Service Designator/Network Channel Code Conversion Table	32
E7.4	Rate Regulations	33
E7.4.1	Types of Rates and Charges	33
E7.4.2	Dedicated Access Service Capable of Using the Local Exchange Network	38
E7.4.3	Reserved for Future Use	39
E7.4.4	Minimum Periods	39
E7.4.5	Moves	39
E7.4.6	Mileage Measurement	40
E7.4.7	Facility Hubs	41
E7.4.8	Shared Use Analog and Digital High Capacity (a.k.a. BellSouth SPA DS0 Digital Data) Services	42
E7.4.9	Reserved for Future Use	43
E7.4.10	Reserved for Future Use	43
E7.4.11	Reserved for Future Use	43
E7.4.12	FlexServ Service (a.k.a. BellSouth SPA Customer Reconfiguration)	43
E7.4.13	Derived Data Channel (a.k.a. BellSouth SPA Derived Data Channel) Service (DDCS)	47
E7.4.14	SMARTRing service (a.k.a. BellSouth Dedicated Ring)	47
E7.4.15	Zone Pricing	48
E7.4.16	Reserved for Future Use	48
E7.4.17	SMARTPath Service (a.k.a. BellSouth SPA Shared Ring)	48.1
E7.4.18	Reserved for Future Use	48.2
E7.4.19	Reserved for Future Use	48.2
E7.4.20	Reserved for Future Use	48.2
E7.4.21	Reserved for Future Use	48.2
E7.4.22	Reserved for Future Use	48.2
E7.4.23	Reserved for Future Use	48.2
E7.4.24	Reserved for Future Use	48.2
E7.4.25	Reserved for Future Use	48.2
E7.4.26	Reserved for Future Use	48.2
E7.4.27	Reserved for Future Use	48.2
E7.4.28	Reserved for Future Use	48.2
E7.4.29	Reserved for Future Use	48.2
E7.4.30	Reserved for Future Use	48.2
E7.4.31	Reserved for Future Use	48.2
E7.4.32	BellSouth Metro Ethernet service	48.3

(T)

BELLSOUTH
TELECOMMUNICATIONS
FLORIDA

ACCESS SERVICES TARIFF

Third Revised Page 1
Cancels Second Revised Page 1

ISSUED: June 29, 2021
BY: Joe York, President -FL
Jacksonville, Florida

EFFECTIVE: June 30, 2021

E7. DEDICATED ACCESS SERVICES

E7.1 General

Dedicated Access Services provide a transmission path to directly connect an IC terminal location in a LATA to the End User's premises¹; two IC terminal locations; an IC terminal location and a HUB; or a HUB and an End User's premises. Dedicated Access Services include all exchange access not utilizing Company end office switches. This type of Access Service is used, for example, by IC's for the provision of private line service. When the Company incurs costs as a result of an IC generated activity, defined as the relocation of an IC POP, Dedicated Access Services nonrecurring charges will be billed to the IC. Prorating of high capacity services among End Users will not be allowed.

The connections provided by Dedicated Access Services can be either analog or digital. Analog connections are differentiated by spectrum and bandwidth. Digital connections are differentiated by bit rate.

E7.1.1 Channel Types

There are six types of channels used to provide Dedicated Access Services. Each type has its own characteristics. All are subdivided by one or more of the following:

- Transmission specifications
- Bandwidth
- Speed (i.e., bit rate)
- Spectrum

Customers can order a basic channel and select from a list of available transmission parameters and channel interfaces, that they desire to meet specific communications requirements.

For purposes of ordering channels, each has been identified as a type of Dedicated Access Service. However, such identification is not intended to limit a customer's use of the channel, nor to imply that the channel is limited to a particular use.

Following is a brief description of each type of channel:

1. Telegraph Grade² (a.k.a. BellSouth SPA Telegraph) (TG) - a channel for the transmission of binary signals at rates of 0 to 75 baud or 0 to 150 baud. (C)
2. Voice Grade² (a.k.a. BellSouth SPA DS0 VG) (VG) - a channel for the transmission of analog signals within an approximate bandwidth of 300-3000 Hz. (C)
3. **(DELETED)**
4. Digital Data Access² (a.k.a. BellSouth SPA DS0 Digital Data) Service (DDAS) - a channel for the digital transmission of synchronous serial data at rates of 2.4, 4.8, 9.6, 19.2, 56.0 or 64.0 Kbps. (C)
5. High Capacity (a.k.a. BellSouth SPA High Capacity) (HC) - a channel for the transmission of isochronous serial digital data at rates of 1.544, 3.152, 6.312, or 44.736 Mbps.
6. Derived Data Channel² (a.k.a. BellSouth SPA Derived Data Channel) - a digital data channel derived from a two-wire local exchange facility that transmits voice and data signals simultaneously. (C)

Note 1: Company Centrex CO-like switches and other Company CO derived services are considered to be End User's premises for purposes of this Tariff.

Note 2: Effective June 30, 2021, this Service will no longer be available for purchase by new or existing customers. In addition, requests to move, add, change, or renew existing service arrangements will not be accepted. Following the expiration of a customer's existing term agreement, service will be provided on a month-to-month basis at the applicable Monthly rates until the service is discontinued. The Company currently plans to discontinue this service on or after June 30, 2024.

(N)
|
(N)

BELLSOUTH
TELECOMMUNICATIONS
FLORIDA

ACCESS SERVICES TARIFF

Sixth Revised Page 2
Cancels Fifth Revised Page 2

ISSUED: November 30, 2021
BY: Joe York, President -FL
Jacksonville, Florida

EFFECTIVE: December 1, 2021

E7. DEDICATED ACCESS SERVICES

E7.1 General (Cont'd)

E7.1.1 Channel Types (Cont'd)

Detailed descriptions of each of the channel types are provided in E7.2 following.

The customer also has the option of ordering digital high capacity facilities (i.e., 1.544 Mbps, 3.152 Mbps, 6.312 Mbps, and 44.736 Mbps) to a Company Hub for channelization to individual channels of a lower capacity. Descriptions of the types of channelization available at the hubs, as well as the number of individual channels which may be derived from each type of facility are set forth in E7.2 following. Additionally, the customer may specify optional features for the individual channels derived from the facility to further tailor the channel to meet specific communications requirements. Descriptions of the optional features and functions available are also set forth in E7.2 following.

For example, a customer may order a 44.736 Mbps facility from a designated premises to a Company Hub for channelization to twenty-eight 1.544 Mbps channels. The 1.544 Mbps channels may be further channelized at the same or a different Hub to Voice Grade¹ (a.k.a. BellSouth SPA DS0 VG) channels or may be extended to other customer designated premises. Optional features may be added to either the 1.544 Mbps or the Voice Grade¹ (a.k.a. BellSouth SPA DS0 VG) channels.

E7.1.2 Rate Categories

The following basic rate categories apply to Dedicated Access Services:

- Local Channels (described in A. following)
- Interoffice Channel (described in B. following)
- Optional Features and Functions (described in C. following)
- SMARTRing^{®2} service (a.k.a. BellSouth Dedicated Ring) (described in F. following)

These basic categories are shown in the diagram in E7.1.3.A.

The rate categories for SMARTPath[®] service are:

- SMARTPath[®] (a.k.a. BellSouth SPA DS1 Shared Ring) Area Connection (described in D. following)
- SMARTPath[®] (a.k.a. BellSouth SPA DS1 Shared Ring) Area Junction (described in E. following)

A. Local Channel

The Local Channel rate category provides for the communications path between a customer designated premises and the serving wire center of that premises. Included as part of the Local Channel is a standard channel interface arrangement which defines the technical characteristics associated with the type of facilities to which the access service is to be connected at the Point of Termination (POT) and the type of signaling capability, if any. The signaling capability itself is provided as an optional feature as set forth in C. following. One Local Channel charge applies per customer designated premises at which the channel is terminated. This charge will apply even if the customer premises and the serving wire center are co-located in a Company building. The Local Channel rate element is further designated as to whether the premises is an End User or an IC terminal location. A Hub Termination charge applies in addition to each Digital Data Access¹ (a.k.a. BellSouth SPA DS0 Digital Data) service Local Channel.

Note 1: Effective June 30, 2021, this Service will no longer be available for purchase by new or existing customers. In addition, requests to move, add, change, or renew existing service arrangements will not be accepted. Following the expiration of a customer's existing term agreement, service will be provided on a month-to-month basis at the applicable Monthly rates until the service is discontinued. The Company currently plans to discontinue this service on or after June 30, 2024.

Note 2: Effective on or after December 1, 2021, neither new nor existing customers will be permitted to purchase new SMARTRing Service (Service). In addition, (A) Service Payment Plans greater than 12-months in length will no longer be available; and (B) requests to move, add, change, upgrade, or downgrade existing service arrangements will not be accepted, with the following exceptions: (1) existing customers will be permitted to modify their existing Service and will be able to add new circuits to their existing Service, but will not be permitted to add new nodes in any locations; and (2) any such new circuits will be subject to the customer's existing term payment plan or term agreement for the Service to which they are added. Following the expiration of a customer's existing term agreement, Service will be provided on a month-to-month basis at the applicable Month-to-Month rates until the Service is discontinued.

Effective November 30, 2023, unless specified to the contrary in their existing Service agreements, existing customers may not renew Term Payment Plans or term agreements for Service. In addition, no move, add, or change orders of any type will be accepted.

BELLSOUTH
TELECOMMUNICATIONS
FLORIDA

ACCESS SERVICES TARIFF

Fourth Revised Page 3
Cancels Third Revised Page 3

ISSUED: November 30, 2021
BY: Joe York, President -FL
Jacksonville, Florida

EFFECTIVE: December 1, 2021

E7. DEDICATED ACCESS SERVICES

E7.1 General (Cont'd)

E7.1.2 Rate Categories (Cont'd)

B. Interoffice Channel

The Interoffice Channel rate category provides for the transmission facilities between the serving wire centers associated with two customer designated premises, between a serving wire center associated with a customer designated premises and a Company Hub or between two Company Hubs. Interoffice Channel is portrayed in mileage bands. There are two rates that apply for each band, i.e., a flat rate per band and a rate per mile.

C. Optional Features and Functions

The Optional Features and Functions rate category provides for optional features and functions which may be added to a Dedicated Access Service to improve its quality or utility to meet specific communications requirements. These are not necessarily identifiable with specific equipment, but rather represent the end result in terms of performance characteristics which may be obtained. These characteristics may be obtained by using various combinations of equipment. Although the equipment necessary to perform a specified function may be installed at various locations along the path of the service, they will be charged for as a single rate element.

Examples of Optional Features and Functions that are available include, but are not limited to, the following:

- Signaling Capability
- Hubbing Functions
- Conditioning
- Transfer Arrangements
- FlexServ[®] service (a.k.a. BellSouth SPA Customer Reconfiguration)

A Hub is a Company designated serving wire center at which bridging or channelization functions are performed. The bridging functions performed are to connect three or more customer designated premises in a multipoint arrangement. The channelization functions are to channelize analog or digital facilities to individual services requiring a lower capacity. National Exchange Carrier Association Tariff FCC No. 4 identifies serving wire centers, Hub locations and the type of bridging or channelization functions available.

Descriptions for each of the available Optional Features and Functions are set forth in E7.2 following.

D. The SMARTPath[®] (a.k.a. BellSouth SPA DS1 Shared Ring) Area Connection provides for the connection at the designated premises where the customer gains access to SMARTPath[®] service (a.k.a. BellSouth SPA DS1 Shared Ring) and transport to a designated junction in the same SMARTPath[®] service (a.k.a. BellSouth SPA DS1 Shared Ring) area.

E. The SMARTPath[®] (a.k.a. BellSouth SPA DS1 Shared Ring) Area Junction provides for the connection between the SMARTPath[®] service (a.k.a. BellSouth SPA DS1 Shared Ring) network and (1) another customer designated premises, in the same SMARTPath[®] service (a.k.a. BellSouth SPA DS1 Shared Ring) Area or (2) a serving wire center in the same SMARTPath[®] service (a.k.a. BellSouth SPA DS1 Shared Ring) Area for connection to (a) DS1 Basic Channelization, FlexServ[®] service (a.k.a. BellSouth SPA Customer Reconfiguration) or DS3 service as provided in Section E7. of this Tariff, or (b) a SMARTPath[®] service (a.k.a. BellSouth SPA DS1 Shared Ring) Area Junction of another SMARTPath[®] service (a.k.a. BellSouth SPA DS1 Shared Ring) area in the same Metropolitan Area.

F. Self-healing Multi-nodal Alternate Route Topology Ring (SMARTRing[®]¹ service [a.k.a. BellSouth Dedicated Ring]) (C)

1. Customer Node

Customer Nodes provide ring switching capabilities at customer designated locations other than Telephone Company Premises that are part of SMARTRing[®] service (a.k.a. BellSouth Dedicated Ring). This rate element offers OC-3, OC-3+, OC-12, OC-48, or OC-48+ network capacities. An OC-1 network capacity is available only in an Overlay Ring Arrangement riding the customer's host OC-12, OC-48, or OC-48+ SMARTRing[®] service (a.k.a. BellSouth Dedicated Ring) installed on or after June 3, 1994. A summary of the channel interfaces available with each node are specified in E7.2.11.A following.

2. Customer Channel Interface

A Customer Channel Interface provides DS1, DS3, STS-1 electrical channelization and/or OC-3 and/or OC-12 optical

Note 1: Effective on or after December 1, 2021, neither new nor existing customers will be permitted to purchase new SMARTRing Service (Service). In addition, (A) Service Payment Plans greater than 12-months in length will no longer be available; and (B) requests to move, add, change, upgrade, or downgrade existing service arrangements will not be accepted, with the following exceptions: (1) existing customers will be permitted to modify their existing Service and will be able to add new circuits to their existing Service, but will not be permitted to add new nodes in any locations; and (2) any such new circuits will be subject to the customer's existing term payment plan or term agreement for the Service to which they are added. Following the expiration of a customer's existing term agreement, Service will be provided on a month-to-month basis at the applicable Month-to-Month rates until the Service is discontinued. (N)

Effective November 30, 2023, unless specified to the contrary in their existing Service agreements, existing customers may not renew Term Payment Plans or term agreements for Service. In addition, no move, add, or change orders of any type will be accepted. (N)

BELLSOUTH
TELECOMMUNICATIONS
FLORIDA

ACCESS SERVICES TARIFF

Second Revised Page 3.1
Cancels First Revised Page 3.1

ISSUED: November 30, 2021
BY: Joe York, President -FL
Jacksonville, Florida

EFFECTIVE: December 1, 2021

E7. DEDICATED ACCESS SERVICES

E7.1 General (Cont'd)

E7.1.2 Rate Categories (Cont'd)

- F. Self-healing Multi-nodal Alternate Route Topology Ring (SMARTRing^{®I} service [a.k.a. BellSouth Dedicated Ring]) (Cont'd) (C)
- 2 Customer Channel Interface (Cont'd)
channelization that may take place at each Customer Node of SMARTRing[®] service (a.k.a. BellSouth Dedicated Ring). The Customer Channel Interface rate element applies for every interface capacity that originates or terminates at a Customer Node. A summary of the channel interfaces available with each node are specified in E7.2.16.A. following.
 3. Central Office Node
Central Office Nodes provide ring switching capabilities at Telephone Company Central Offices that are a part of SMARTRing[®] service (a.k.a. BellSouth Dedicated Ring). This rate element offers OC-3, OC-3+, OC-12, OC-48, and OC-48+ network capacities. An OC-1 network capacity is available only in an Overlay Ring Arrangement riding the customer's host OC-12, OC-48 or OC-48+ SMARTRing[®] service (a.k.a. BellSouth Dedicated Ring) installed on or after June 3, 1994. A summary of the channel interfaces available with each node are specified in E7.2.16.A. following.
 4. Central Office Channel Interface
A Central Office Channel Interface provides DS1, DS3, STS-1 electrical channelization and/or OC-3 and/or OC-12 optical channelization that may take place at each Central Office Node located on SMARTRing[®] service (a.k.a. BellSouth Dedicated Ring). The Central Office Channel Interface rate element applies for every interface capacity that originates or terminates at a Central Office Node. A summary of the channel interfaces available with each node are specified in E7.2.16.A. following. Customers with DS3 or STS-1 interfaces at the Customer Node electing to connect with DS1 services at a Central Office Node, must obtain a 28-DS1 Channel System.
 5. Local Channel
The Local Channel rate category provides for the communications path between a Customer Node and the serving wire center of the premises where located. Charges for Local Channels apply as described in A. preceding. It is available with all capacities of SMARTRing[®] service (a.k.a. BellSouth Dedicated Ring) except OC-1.
 6. Alternate Central Office Channel
The Alternate Central Office Channel provides for the communications path between a customer node and an alternate central office. It is available with all capacities of SMARTRing[®] service (a.k.a. BellSouth Dedicated Ring) except OC-1.
 7. Interoffice Channel
The Interoffice Channel provides for the communications path between directly connected Telephone Company central offices located on a SMARTRing[®] service (a.k.a. BellSouth Dedicated Ring). It is available with all capacities of SMARTRing[®] service (a.k.a. BellSouth Dedicated Ring) except OC-1. This rate element does not apply where Central Office Nodes are adjacently connected in the same Central Office on the same SMARTRing[®] service (a.k.a. BellSouth Dedicated Ring) for the purpose of providing additional node capacity.
 - 8 Internodal Channel
The Internodal Channel provides for the communications path between two directly connected Customer Nodes of a given SMARTRing[®] service (a.k.a. BellSouth Dedicated Ring) located (a) in the same Serving Wire Center area or (b) in the same Office Park/Campus Environment or contiguous property, located in contiguous Serving Wire Center areas. It is available with all capacities of SMARTRing[®] service (a.k.a. BellSouth Dedicated Ring) except OC-1. This rate element does not apply where Customer Nodes are adjacently connected in the same building on the same SMARTRing[®] service (a.k.a. BellSouth Dedicated Ring) for the purpose of providing additional node capacity.
 9. Channel Interface Capacity Reallocation
Channel Interface Capacity Reallocation allows the customer to reallocate STS-1, DS3 capacity interfaces at each node subsequent to the initial service installation.
- Note 1:** Effective on or after December 1, 2021, neither new nor existing customers will be permitted to purchase new SMARTRing Service (Service). In addition, (A) Service Payment Plans greater than 12-months in length will no longer be available; and (B) requests to move, add, change, upgrade, or downgrade existing service arrangements will not be accepted, with the following exceptions: (1) existing customers will be permitted to modify their existing Service and will be able to add new circuits to their existing Service, but will not be permitted to add new nodes in any locations; and (2) any such new circuits will be subject to the customer's existing term payment plan or term agreement for the Service to which they are added. Following the expiration of a customer's existing term agreement, Service will be provided on a month-to-month basis at the applicable Month-to-Month rates until the Service is discontinued. (N)
- Effective November 30, 2023, unless specified to the contrary in their existing Service agreements, existing customers may not renew Term Payment Plans or term agreements for Service. In addition, no move, add, or change orders of any type will be accepted. (N)

BELLSOUTH
TELECOMMUNICATIONS
FLORIDA
ISSUED: October 10, 2014
BY: Joe York, President -FL
Jacksonville, Florida

ACCESS SERVICES TARIFF

Second Revised Page 3.2
Cancels First Revised Page 3.2

EFFECTIVE: October 11, 2014

E7. DEDICATED ACCESS SERVICES

E7.1 General (Cont'd)

E7.1.2 Rate Categories (Cont'd)

G. (DELETED)

(D)

H. Access Collocation Cross-Connects

Access Collocation Cross-Connects provide a means for customers to interconnect their Shared Use and Digital High Capacity (a.k.a. BellSouth SPA High Capacity) to Central Office Collocation arrangements within the same Central Office. Terms, conditions, and rates for Physical Access Collocation Cross-Connects and Virtual Access Collocation Cross-Connects are set forth in Section E13. of this Tariff.

(D)

E7. DEDICATED ACCESS SERVICES

E7.1 General (Cont'd)

E7.1.3 Service Configurations

There are *three* types of service configurations over which Dedicated Access Services are provided: two-point service, multipoint service and *SmartRing*® service (a.k.a. *BellSouth Dedicated Ring*).

A change from *one Dedicated Access service configuration to another* will be treated as a discontinuance of existing service and an installation of a new service as set forth in E5.6 preceding, except for FlexServ® service (a.k.a. BellSouth SPA Customer Reconfiguration) reconfigurations.

A. Two-Point Service

A two-point service connects two customer designated premises, either on a directly connected basis or through a hub where channelization functions are performed.

Applicable rate elements are:

- Local Channels
- Interoffice Channel (as applicable)
- Optional Features and Functions (when applicable)

The following diagram depicts a two-point Voice Grade² (a.k.a. BellSouth SPA DS0 VG) service connecting two customer designated premises located 15 miles apart. The service is provided with C-Type Conditioning. (C)

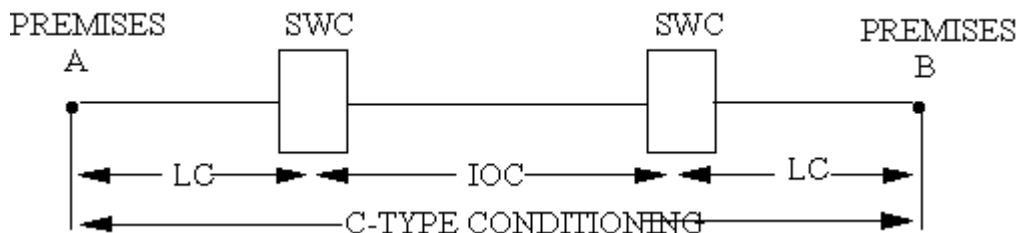

- LC - Local Channel¹
- IOC - Interoffice Channel
- SWC - Serving Wire Center

Applicable rate elements are:

- Local Channels¹(2 applicable)
- Interoffice Channel (mileage band Over 8 to 25 miles)
- Interoffice Channel (mileage band Over 8 to 25 miles)
- C-Type conditioning Optional Feature

Note 1: Two Local Channels are applicable.

Note 2: Effective June 30, 2021, this Service will no longer be available for purchase by new or existing customers. In addition, requests to move, add, change, or renew existing service arrangements will not be accepted. Following the expiration of a customer's existing term agreement, service will be provided on a month-to-month basis at the applicable Monthly rates until the service is discontinued. The Company currently plans to discontinue this service on or after June 30, 2024.

(N)
|
(N)

Material appearing on this page previously appeared on pages 3 of this section.

® Registered Service Mark of BellSouth Corporation

BELLSOUTH
TELECOMMUNICATIONS
FLORIDA
ISSUED: February 14, 1997
BY: Joe York, President -FL
Jacksonville, Florida

ACCESS SERVICES TARIFF

First Revised Page 5
Cancels Original Page 5

EFFECTIVE: March 1, 1997

E7. DEDICATED ACCESS SERVICES

(T)

E7.1 General (Cont'd)**E7.1.3 Service Configurations (Cont'd)**

B. Multipoint Service

Multipoint service connects three or more designated premises through a Company Hub. There is no limitation on the number of mid-links available with multipoint service. However, when more than three mid-links are provided in tandem, the quality of the service may be degraded. A mid-link is a channel between hubs (i.e., bridging locations). Only certain types of Dedicated Access Service are provided as multipoint service. These are so designated in the Service Descriptions set forth in E7.2. following. Charges for Multipoint service will be billed to one customer.

Multipoint service utilizing a customized technical specifications package as set forth in E7.2. following will be provided when technically possible. If the Company determines that the requested characteristics for a multipoint service are not compatible, the customer will be advised and given the opportunity to change the order.

When ordering, the customer will specify the desired bridging Hub(s) selected from the Exchange Carrier Association Tariff F.C.C. No. 4. This tariff identifies the type(s) of bridging functions which are available and the serving wire centers at which they are available.

Applicable Rate Elements are:

- Local Channels (one per customer designated premises)
- Interoffice Channel (as applicable between each designated customer premises and the Hub and between Hubs)
- Bridging
- Additional Optional Features (when applicable)

E7. DEDICATED ACCESS SERVICES

E7.1 General (Cont'd)

E7.1.3 Service Configurations (Cont'd)

B. Multipoint Service (Cont'd)

Example: Voice Grade¹ (a.k.a. *BellSouth SPA DSO VG*) multipoint connecting four customer premises via two customer specified bridging hubs. (C)

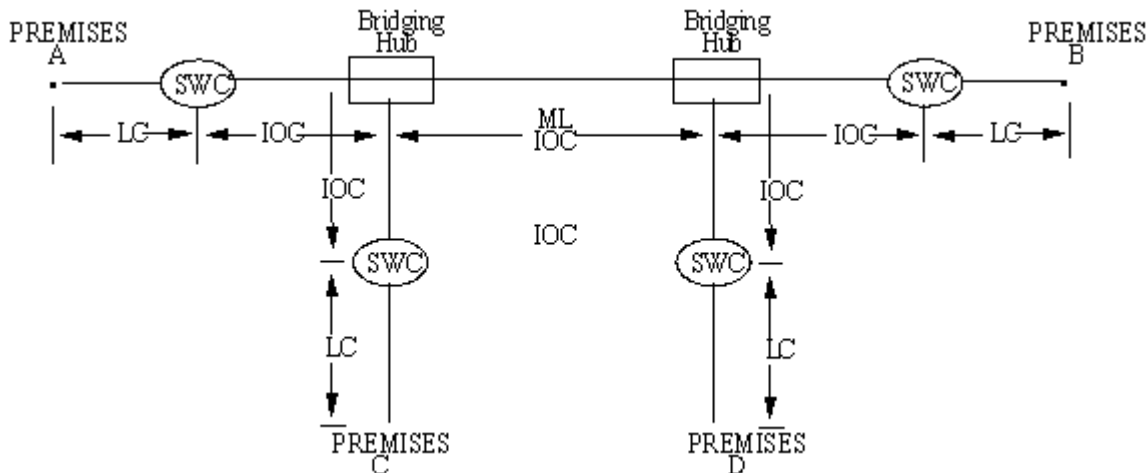

- IOC - Interoffice Channel
- B - Bridging
- SWC - Serving Wire Center
- LC - Local Channel

Applicable rate elements are:

- Local Channels (4 applicable)
- Interoffice Channel (5 sections, each from appropriate mileage band)
- Bridging Optional Feature (6 applicable, i.e., each bridge port)

Note 1: Effective June 30, 2021, this Service will no longer be available for purchase by new or existing customers. In addition, requests to move, add, change, or renew existing service arrangements will not be accepted. Following the expiration of a customer's existing term agreement, service will be provided on a month-to-month basis at the applicable Monthly rates until the service is discontinued. The Company currently plans to discontinue this service on or after June 30, 2024.

(N)
 |
 (N)

BELLSOUTH
TELECOMMUNICATIONS
FLORIDA

ACCESS SERVICES TARIFF

First Revised Page 6.1
Cancels Original Page 6.1

ISSUED: November 30, 2021
BY: Joe York, President -FL
Jacksonville, Florida

EFFECTIVE: December 1, 2021

E7. DEDICATED ACCESS SERVICES

E7.1 General (Cont'd)

E7.1.3 Service Configurations (Cont'd)

- C. SMARTRing[®] service (a.k.a. BellSouth Dedicated Ring) (C)
1. The SMARTRing[®] service (a.k.a. BellSouth Dedicated Ring) configuration utilizes a multi-nodal ring architecture which is specified jointly by the Telephone Company and the customer. The minimum configuration provides dedicated DS3 and/or DS1 digital services and must include at least three nodes. The three nodes may all be Central Office Nodes in Telephone Company Central Offices, or the three nodes may be a Central Office Node in a Telephone Company Central Office, a Customer Node at a customer's designated location and the third node may be either a Central Office Node or a node at another customer designated location. Additional nodes for either arrangement may be any combination thereof. (D)
The maximum number of nodes will be determined based on equipment capability. The nodes are connected by SMARTRing[®] service (a.k.a. BellSouth Dedicated Ring) Local Channels, Alternate Central Office Channels, Interoffice Channels and Internodal Channels as applicable. SMARTRing[®] service (a.k.a. BellSouth Dedicated Ring) may be connected to other DS3/DS1 services only at Central Office Nodes. With OC-12 SMARTRing[®] service (a.k.a. BellSouth Dedicated Ring) installed on or after June 3, 1994, and with OC-48 and OC-48+ SMARTRing[®] service (a.k.a. BellSouth Dedicated Ring) the customer may request an OC-1 and/or OC-3 Overlay Ring Arrangement riding the customer's host OC-12, OC-48, or OC-48+ SMARTRing[®] service (a.k.a. BellSouth Dedicated Ring). With OC-48 SMARTRing[®] service (a.k.a. BellSouth Dedicated Ring), the customer may request an OC-3+ and/or OC-12 Overlay Ring Arrangement riding the customer's host OC-48 SMARTRing[®] service (a.k.a. BellSouth Dedicated Ring). In an Overlay Ring Arrangement, node and channel configuration requirements apply to the host SMARTRing[®] service (a.k.a. BellSouth Dedicated Ring).
 2. Applicable rate elements for this service are:
 - a. Customer Node (at least one for configurations other than three Central Office Node arrangement)
 - b. Customer Channel Interface (one for each originating/terminating activated DS1, DS3, STS-1, OC-3, and/or OC-12 for each Customer Node)
 - c. Central Office Node (at least one for configurations other than three Central Office Node arrangement)
 - d. Central Office Channel Interface (one for each originating/terminating activated DS1, DS3, STS-1, OC-3 and/or OC-12 for each Central Office Node or one for each 28 DS1 Channel System and associated DS1 Channel Interfaces for each activated DS3)
 - e. Local Channel (at least one for each Customer Node which is directly connected to the serving wire center)
 - f. Alternate Central Office Channel (at least one for each Customer Node which is directly connected to an Alternate Central Office)
 - g. Internodal Channel (one for each path between two directly connected customer nodes)
 - h. Interoffice Channel (one for each path between each two directly connected Telephone Company Central Offices)
 - i. Channel Interface Capacity Reallocation (one per node per occurrence)

Note 1: Effective on or after December 1, 2021, neither new nor existing customers will be permitted to purchase new SMARTRing Service (Service). In addition, (A) Service Payment Plans greater than 12-months in length will no longer be available; and (B) requests to move, add, change, upgrade, or downgrade existing service arrangements will not be accepted, with the following exceptions: (1) existing customers will be permitted to modify their existing Service and will be able to add new circuits to their existing Service, but will not be permitted to add new nodes in any locations; and (2) any such new circuits will be subject to the customer's existing term payment plan or term agreement for the Service to which they are added. Following the expiration of a customer's existing term agreement, Service will be provided on a month-to-month basis at the applicable Month-to-Month rates until the Service is discontinued. (N)
Effective November 30, 2023, unless specified to the contrary in their existing Service agreements, existing customers may not renew Term Payment Plans or term agreements for Service. In addition, no move, add, or change orders of any type will be accepted. (N)

E7. DEDICATED ACCESS SERVICES

E7.1 General (Cont'd)

E7.1.3 Service Configurations

C. SMARTRing[®] service (a.k.a. BellSouth Dedicated Ring) (Cont'd)

(C)

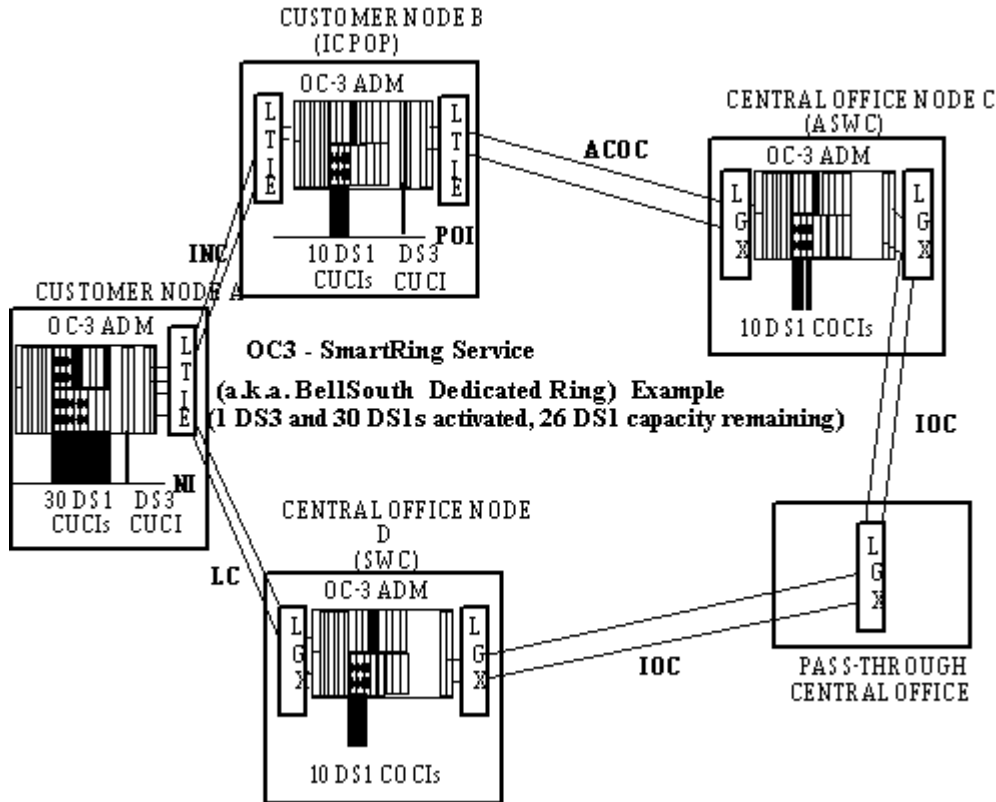

Example: SMARTRing[®] service (a.k.a. BellSouth Dedicated Ring) OC-3 capacity.

For this example the following rate elements are applicable:

(C)

- 2 Customer Nodes
- 2 Central Office Nodes
- 1 Local Channel
- 1 Internodal Channel
- 1 Alternate Central Office Channel
- 2 Interoffice Channels
- 2 DS3 Customer Channel Interfaces
- 40 DS1 Customer Channel Interfaces
- 20 DS1 Central Office Channel Interfaces

Note 1: Effective on or after December 1, 2021, neither new nor existing customers will be permitted to purchase new SMARTRing Service (Service). In addition, (A) Service Payment Plans greater than 12-months in length will no longer be available; and (B) requests to move, add, change, upgrade, or downgrade existing service arrangements will not be accepted, with the following exceptions: (1) existing customers will be permitted to modify their existing Service and will be able to add new circuits to their existing Service, but will not be permitted to add new nodes in any locations; and (2) any such new circuits will be subject to the customer's existing term payment plan or term agreement for the Service to which they are added. Following the expiration of a customer's existing term agreement, Service will be provided on a month-to-month basis at the applicable Month-to-Month rates until the Service is discontinued.

(N)

Effective November 30, 2023, unless specified to the contrary in their existing Service agreements, existing customers may not renew Term Payment Plans or term agreements for Service. In addition, no move, add, or change orders of any type will be accepted.

(N)

E7. DEDICATED ACCESS SERVICES

E7.1 General (Cont'd)

E7.1.3 Service Configurations (Cont'd)

C. SMARTRing[®] service (a.k.a. BellSouth Dedicated Ring) (Cont'd)

(C)

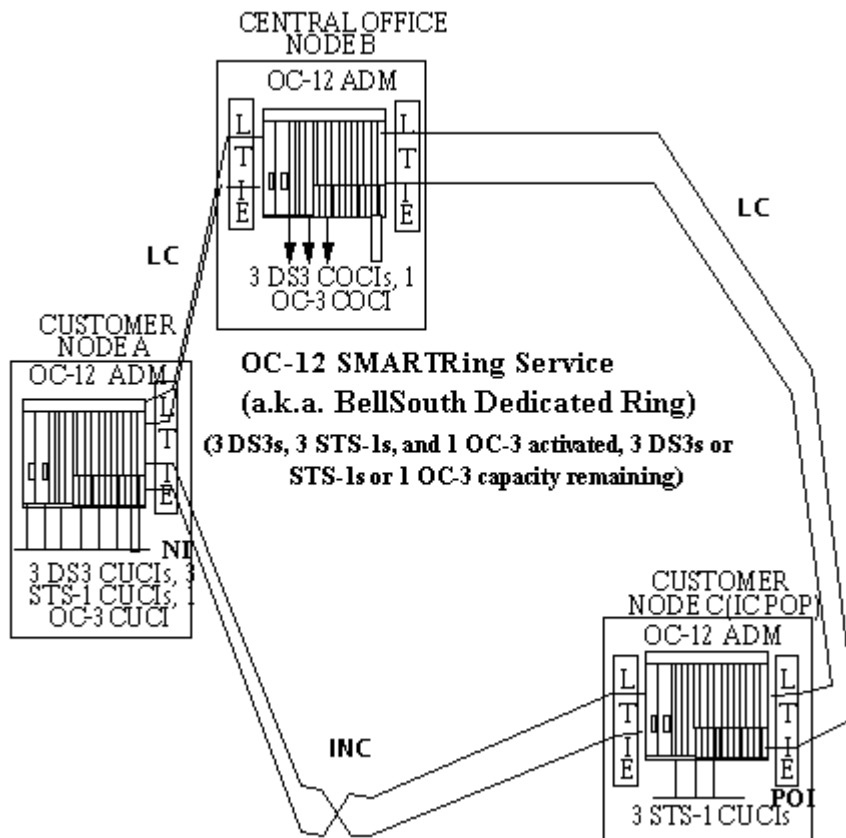

Example: SMARTRing[®] service (a.k.a. BellSouth Dedicated Ring) OC-12 capacity.

For this example the following rate elements are applicable:

(C)

- 2 Customer Nodes 1 Internodal Channel 6 STS 1 Customer Channel Interfaces
- 1 Central Office Nodes 3 DS3 Customer Channel Interfaces 1 OC 3 Customer Channel Interface
- 2 Local Channels 3 DS3 Central Office Channel Interfaces 1 OC 3 Central Office Channel Interface

Note 1: Effective on or after December 1, 2021, neither new nor existing customers will be permitted to purchase new SMARTRing Service (Service). In addition, (A) Service Payment Plans greater than 12-months in length will no longer be available; and (B) requests to move, add, change, upgrade, or downgrade existing service arrangements will not be accepted, with the following exceptions: (1) existing customers will be permitted to modify their existing Service and will be able to add new circuits to their existing Service, but will not be permitted to add new nodes in any locations; and (2) any such new circuits will be subject to the customer's existing term payment plan or term agreement for the Service to which they are added. Following the expiration of a customer's existing term agreement, Service will be provided on a month-to-month basis at the applicable Month-to-Month rates until the Service is discontinued.

(N)

Effective November 30, 2023, unless specified to the contrary in their existing Service agreements, existing customers may not renew Term Payment Plans or term agreements for Service. In addition, no move, add, or change orders of any type will be accepted.

(N)

E7. DEDICATED ACCESS SERVICES

E7.1 General (Cont'd)

E7.1.3 Service Configurations (Cont'd)

C. SMARTRing[®] service (a.k.a. BellSouth Dedicated Ring) (Cont'd)

(C)

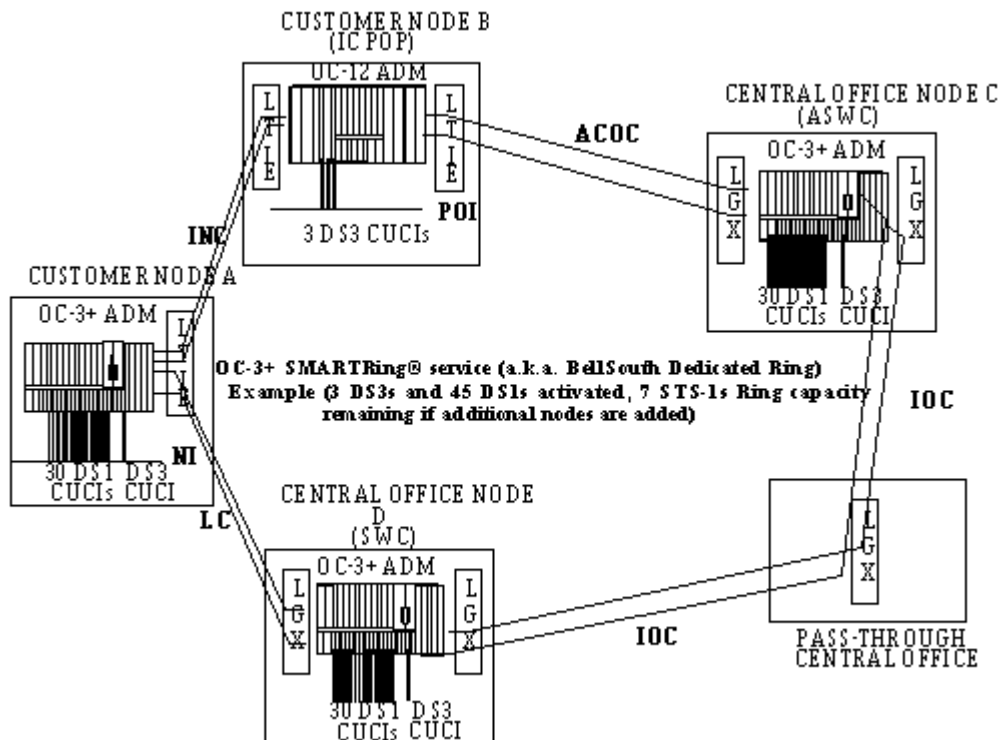

Example: SMARTRing[®] service (a.k.a. BellSouth Dedicated Ring) OC-3+ capacity.

For this example the following rate elements are applicable:

(C)

- 2 Customer Nodes 1 Alternate Central Office Channel 2 DS3 Central Office Channel Interfaces
- 2 Central Office Nodes 2 Interoffice Channels 30 DS1 Customer Channel Interfaces
- 1 Local Channel 4 DS3 Customer Channel Interfaces 60 DS1 Central Office Channel Interfaces
- 1 Internodal Channel

Note 1: Effective on or after December 1, 2021, neither new nor existing customers will be permitted to purchase new SMARTRing Service (Service). In addition, (A) Service Payment Plans greater than 12-months in length will no longer be available; and (B) requests to move, add, change, upgrade, or downgrade existing service arrangements will not be accepted, with the following exceptions: (1) existing customers will be permitted to modify their existing Service and will be able to add new circuits to their existing Service, but will not be permitted to add new nodes in any locations; and (2) any such new circuits will be subject to the customer's existing term payment plan or term agreement for the Service to which they are added. Following the expiration of a customer's existing term agreement, Service will be provided on a month-to-month basis at the applicable Month-to-Month rates until the Service is discontinued.

(N)

Effective November 30, 2023, unless specified to the contrary in their existing Service agreements, existing customers may not renew Term Payment Plans or term agreements for Service. In addition, no move, add, or change orders of any type will be accepted.

(N)

E7. DEDICATED ACCESS SERVICES

E7.1 General (Cont'd)

E7.1.3 Service Configurations (Cont'd)

C. SMARTRing[®] service (a.k.a. BellSouth Dedicated Ring) (Cont'd)

(C)

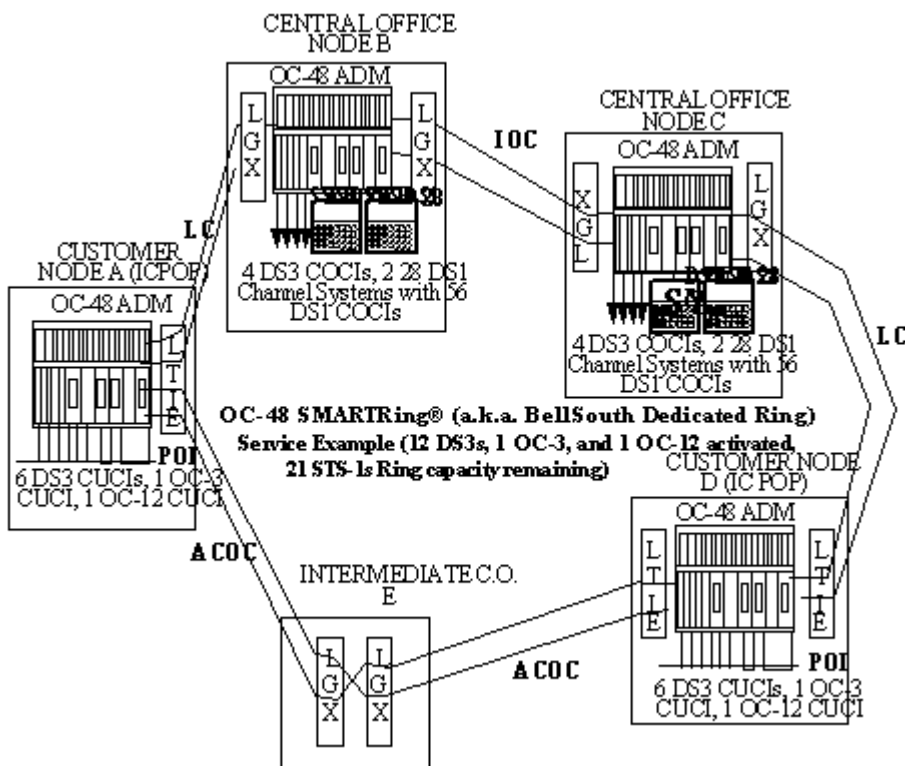

Example: SMARTRing[®] service (a.k.a. BellSouth Dedicated Ring) OC-48 capacity.

For this example the following rate elements are applicable:

(C)

- 2 Customer Nodes
- 2 Central Office Nodes
- 2 Local Channels
- 1 Interoffice Channel
- 2 Alternate Central Office Channels
- 12 DS3 Customer Channel Interfaces
- 8 DS3 Central Office Channel Interfaces
- 4 28 DS1 Channel Systems (DS3)
- 112 DS1 Central Office Channel Interfaces
- 2 OC 3 Customer Channel Interfaces
- 2 OC 12 Customer Channel Interfaces

Note 1: Effective on or after December 1, 2021, neither new nor existing customers will be permitted to purchase new SMARTRing Service (Service). In addition, (A) Service Payment Plans greater than 12-months in length will no longer be available; and (B) requests to move, add, change, upgrade, or downgrade existing service arrangements will not be accepted, with the following exceptions: (1) existing customers will be permitted to modify their existing Service and will be able to add new circuits to their existing Service, but will not be permitted to add new nodes in any locations; and (2) any such new circuits will be subject to the customer's existing term payment plan or term agreement for the Service to which they are added. Following the expiration of a customer's existing term agreement, Service will be provided on a month-to-month basis at the applicable Month-to-Month rates until the Service is discontinued.

(N)

Effective November 30, 2023, unless specified to the contrary in their existing Service agreements, existing customers may not renew Term Payment Plans or term agreements for Service. In addition, no move, add, or change orders of any type will be accepted.

(N)

E7. DEDICATED ACCESS SERVICES

E7.1 General (Cont'd)

E7.1.3 Service Configurations (Cont'd)

C. SMARTRing[®] service (a.k.a. BellSouth Dedicated Ring) (Cont'd)

(C)

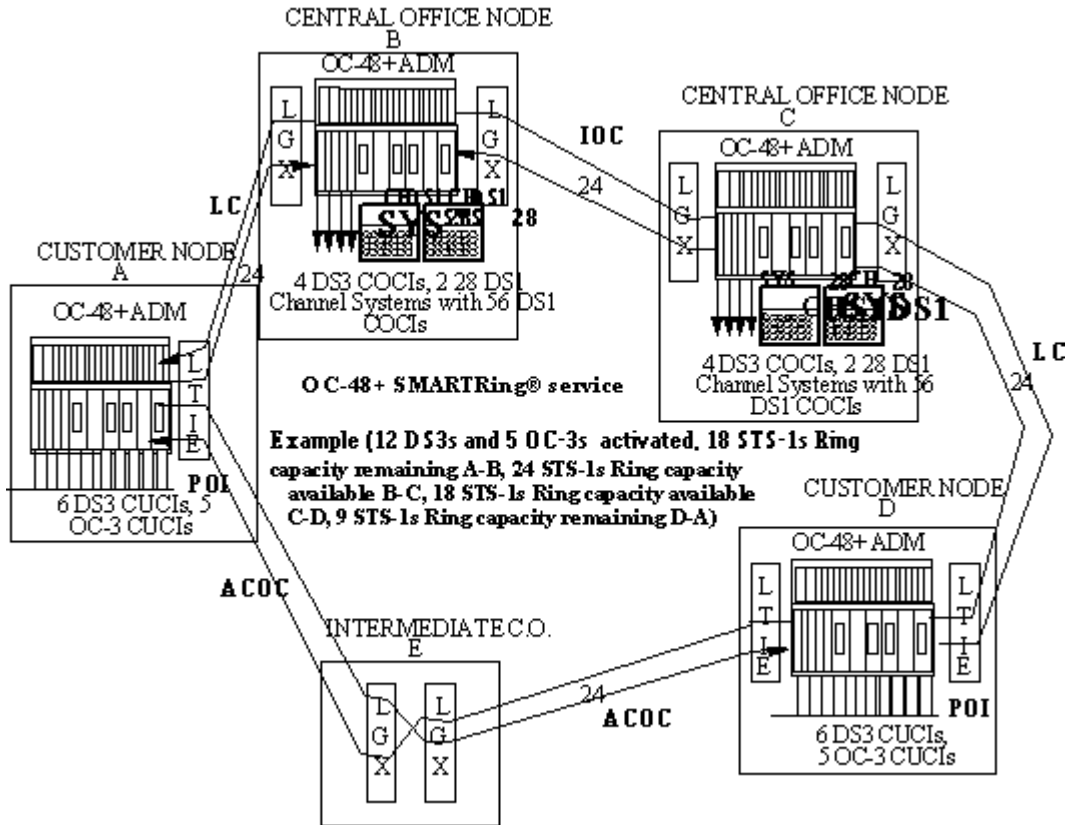

Example: SMARTRing[®] service (a.k.a. BellSouth Dedicated Ring) service OC-48+ capacity.

For this example the following rate elements are applicable:

(C)

- 2 Customer Nodes 2 Alternate Central Office Channels 4 28 DS1 Channel Systems (DS3)
- 2 Central Office Nodes 12 DS3 Customer Channel Interfaces 112 DS1 Central Office Channel Interfaces
- 2 Local Channels 8 DS3 Central Office Channel Interfaces 10 OC 3 Customer Channel Interfaces
- 1 Interoffice Channel

Note 1: Effective on or after December 1, 2021, neither new nor existing customers will be permitted to purchase new SMARTRing Service (Service). In addition, (A) Service Payment Plans greater than 12-months in length will no longer be available; and (B) requests to move, add, change, upgrade, or downgrade existing service arrangements will not be accepted, with the following exceptions: (1) existing customers will be permitted to modify their existing Service and will be able to add new circuits to their existing Service, but will not be permitted to add new nodes in any locations; and (2) any such new circuits will be subject to the customer's existing term payment plan or term agreement for the Service to which they are added. Following the expiration of a customer's existing term agreement, Service will be provided on a month-to-month basis at the applicable Month-to-Month rates until the Service is discontinued.

(N)

Effective November 30, 2023, unless specified to the contrary in their existing Service agreements, existing customers may not renew Term Payment Plans or term agreements for Service. In addition, no move, add, or change orders of any type will be accepted.

(N)

BELLSOUTH
TELECOMMUNICATIONS
FLORIDA
ISSUED: June 29, 2021
BY: Joe York, President -FL
Jacksonville, Florida

ACCESS SERVICES TARIFF

Second Revised Page 7
Cancels First Revised Page 7

EFFECTIVE: June 30, 2021

E7. DEDICATED ACCESS SERVICES**E7.1 General (Cont'd)****E7.1.4 Alternate Use**

Alternate Use occurs when a service is arranged by the Company so that the End User can select different types of transmission at different times. The End User may use a service in any privately beneficial manner. However, where technical or engineering changes are required to effectuate an alternate use, the Company will make such special arrangements available on an individual case basis.

The arrangement required to transfer the service from one operation to the other (i.e., the transfer relay and control leads) will be rated and provided on an individual case basis and filed in Section E12., Specialized Service or Arrangements. The End User will pay the stated tariff rates for the Access Service rate elements for the service ordered (i.e., Local Channels, Interoffice Channel (as applicable) and Optional Features and Functions (if any)).

E7.1.5 Special Facilities Routing

A customer may request that the facilities used to provide Dedicated Access Services be specially routed. The regulations, rates and charges or Special Facilities Routing (i.e., Avoidance, Diversity and Cable Only) are set forth in Section E11.

E7.1.6 Design Layout Report

At the request of the customer, the Company will provide the make-up of the facilities and services provided under this Tariff as Dedicated Access Services to aid the customer in designing its overall service. This information will be provided in the form of a Design Layout Report. The Design Layout Report will be provided to the customer at no charge, and will be reissued whenever these facilities are materially changed.

E7.1.7 Acceptance Testing

At no additional charge, the Company will, at the customer's request, cooperatively test, at the time of installation, the following parameters:

- A. For Voice Grade¹ (*a.k.a. BellSouth SPA DS0 VG*) services, acceptance tests will include tests for loss, 3-tone slope, DC continuity, operational signaling, C-notched noise and C-message noise when these parameters are applicable and specified in the order for service. Additionally, for Voice Grade¹ (*a.k.a. BellSouth SPA DS0 VG*) services, a balance (improved loss) test will be made if the customer has ordered the improved return loss optional feature. (C)
- B. For digital services (i.e., Digital Data¹ (*a.k.a. BellSouth SPA DS0 Digital Data*), and High Capacity (*a.k.a. BellSouth SPA High Capacity*)), acceptance tests will include tests for the parameters applicable to the service as specified in the order for service. (C)

Note 1: Effective June 30, 2021, this Service will no longer be available for purchase by new or existing customers. In addition, requests to move, add, change, or renew existing service arrangements will not be accepted. Following the expiration of a customer's existing term agreement, service will be provided on a month-to-month basis at the applicable Monthly rates until the service is discontinued. The Company currently plans to discontinue this service on or after June 30, 2024.

(N)
|
(N)

BELLSOUTH
TELECOMMUNICATIONS
FLORIDA
ISSUED: June 29, 2021
BY: Joe York, President -FL
Jacksonville, Florida

ACCESS SERVICES TARIFF

Fifth Revised Page 8
Cancels Fourth Revised Page 8

EFFECTIVE: June 30, 2021

E7. DEDICATED ACCESS SERVICES**E7.1 General (Cont'd)****E7.1.7 Acceptance Testing (Cont'd)**

- B. For digital services (i.e., Digital Data¹ (a.k.a. BellSouth SPA DS0 Digital Data), and High Capacity (a.k.a. BellSouth SPA High Capacity), acceptance tests will include tests for the parameters applicable to the service as specified in the order for service. (Cont'd) (C)
- In addition to the preceding tests, Additional Cooperative Acceptance Testing for Voice Grade¹ (a.k.a. BellSouth SPA DS0 VG) service to test other parameters, as described in E13.3.5.B., is available at the customer's request. All test results will be made available to the customer upon request. (C)
- C. If acceptance tests are not started within 30 minutes after the scheduled appointment time for such tests, as negotiated between the Company and the IC, additional charges may apply to the IC, as set forth in Section E13.

E7.1.8 Ordering Options and Conditions

The options and conditions for access orders are set forth in detail in Section E5. Also included in that section are other charges which may be associated with ordering Dedicated Access Services (e.g., Service Date Change Charges, Cancellation Charges, etc.).

E7.1.9 Jurisdictional Report Requirements

An IC or End User must order Dedicated Access Services for either interstate or intrastate use. Dedicated Access Services connecting to an interstate facility, either directly or through a customer provided switch, must be ordered as interstate Special Access (a.k.a. BellSouth SPA) service in accordance with the applicable rules and regulations of the BellSouth Telecommunications, Inc. Tariff F.C.C. No. 1.

E7.2 Service Description

For the purpose of ordering, there are *six* categories of Dedicated Access Services. These are:

1. Telegraph Grade¹ (a.k.a. BellSouth SPA Telegraph) (TG) (C)
2. Voice Grade¹ (a.k.a. BellSouth SPA DS0 VG) (VG) (C)
3. Digital Data Access¹ (a.k.a. BellSouth SPA DS0 Digital Data) service (DDAS) (C)
4. High Capacity (a.k.a. BellSouth SPA High Capacity) (HC) (C)
5. Self-Healing Rings (SMARTRing service (a.k.a. BellSouth Dedicated Ring) (C)
6. Derived Data Channel¹ (a.k.a. BellSouth SPA Derived Data Channel) service (C)

Each service consists of a basic channel to which a technical specifications package (predefined), channel interface(s) and, when desired, optional features and functions are added to construct the service desired. Each of the components of the service are described in this section. *Terms, conditions, and rates for Physical Collocation Cross-Connects and Virtual Access Collocation Cross-Connects are set forth in Section E13. of this Tariff for those services that are permitted to connect directly to a carrier's collocation space.*

Note 1: Effective June 30, 2021, this Service will no longer be available for purchase by new or existing customers. In addition, requests to move, add, change, or renew existing service arrangements will not be accepted. Following the expiration of a customer's existing term agreement, service will be provided on a month-to-month basis at the applicable Monthly rates until the service is discontinued. The Company currently plans to discontinue this service on or after June 30, 2024. (N)

BELLSOUTH
TELECOMMUNICATIONS
FLORIDA
ISSUED: June 29, 2021
BY: Joe York, President -FL
Jacksonville, Florida

ACCESS SERVICES TARIFF

Third Revised Page 9
Cancels Second Revised Page 9

EFFECTIVE: June 30, 2021

E7. DEDICATED ACCESS SERVICES**E7.2 Service Description (Cont'd)**

The channel description specifies the characteristics of the basic channel and indicates whether the channel is provided between customer designated premises or between a customer designated premises and a Company hub where bridging and/or channelization functions are performed.

Information pertaining to the technical specifications packages indicates the transmission parameters that are available with each package. This information is displayed in a matrix found in each service description (e.g., VG matrix in E7.2.3.B. following) with the transmission parameters listed down the left side and the packages listed across the top. Each package is identified by a code, e.g., VG1. The first two letters of the code indicate the category of Dedicated Access Services to which the parameters are applicable. These two-letter codes are shown preceding in parentheses following the category of Dedicated Access Services. The number "1" following the two-letter code indicates the technical specifications package for a service. A numeric or alpha-numeric designation following the two letter code indicates the specific predefined package. When appropriate, the Technical Reference which contains detailed specifications for the parameters is shown following the matrix.

Channel interfaces at each point of termination on a two-point service may be symmetrical or asymmetrical. On a multipoint service they may also be symmetrical or asymmetrical. However, communications can only be provided between points of termination with compatible channel interfaces. Only certain channel interfaces are compatible. These are set forth in a combination format.

Only certain channel interface combinations are available with the predefined technical specifications packages. These are delineated in the Technical References set forth herein.

The optional features and functions available with each type of Dedicated Access Services are described in this section. The optional features and functions information also indicates with which technical specifications packages they are available. Such information is displayed in a matrix with the optional feature or function listed down the left side and the technical specifications package listed across the top.

The Company will maintain existing transmission specifications on services installed prior to the effective date of this Tariff, except that the existing services with performance specifications exceeding the standard listed in this provision will be maintained at the performance levels specified in this Tariff.

All services installed after the effective date of this Tariff will conform to the transmission specification standards contained in this Tariff or in the following Technical References for such category of service:

Telegraph Grade ¹ (a.k.a. BellSouth SPA Telegraph)	TR-NPL-000336	(C)
Voice Grade ¹ (a.k.a. BellSouth SPA DSO VG)	TR-NPL-000335	(C)
Digital Data ¹ (a.k.a. BellSouth SPA DSO Digital Data)	TR-NPL-000341	(C)
For 2.4, 4.8,9.6 and 56.0 Kbps	BellCore PUB 62310	
For 19.2 Kbps	INC. BULLETIN CB-INC-100	
For 64.0 Kbps	AT&T PUB 62310	
High Capacity (a.k.a. BellSouth SPA High Capacity)	TA-TSY-000342 TR-NPL-000054	
(DELETED)		
Derived Data Channel ¹ (a.k.a. BellSouth SPA Derived Data Channel) Service	BellSouth TR-73548 BellSouth TR-73548, Addendum 1	(C)

Note 1: Effective June 30, 2021, this Service will no longer be available for purchase by new or existing customers. In addition, requests to move, add, change, or renew existing service arrangements will not be accepted. Following the expiration of a customer's existing term agreement, service will be provided on a month-to-month basis at the applicable Monthly rates until the service is discontinued. The Company currently plans to discontinue this service on or after June 30, 2024.

(N)
|
(N)

BELLSOUTH
 TELECOMMUNICATIONS
 FLORIDA
 ISSUED: June 29, 2021
 BY: Joe York, President -FL
 Jacksonville, Florida

ACCESS SERVICES TARIFF

Fourth Revised Page 10
 Cancels Third Revised Page 10

EFFECTIVE: June 30, 2021

E7. DEDICATED ACCESS SERVICES

E7.2 Service Description (Cont'd)

E7.2.1 Reserved for Future Use

E7.2.2 Telegraph Grade² (a.k.a. BellSouth SPA Telegraph) Service

(C)

A. Basic Channel Description

A Telegraph Grade (a.k.a. BellSouth SPA Telegraph) channel is an unconditioned channel capable of transmitting binary signals at rates of 0-75 baud or 0-150 baud. This channel is furnished for half-duplex or duplex operation. Telegraph Grade (a.k.a. BellSouth SPA Telegraph) channels are provided between customer designated premises or between a customer designated premises and a Company Hub. Telegraph Grade service is not available for additions, new installations or moves of service.

B. Technical Specifications Packages

Parameter	TG Matrix	
	1	2
Telegraph Distortion	X	X

The technical specifications are delineated in Technical Reference TR-NPL-000336.

C. Channel Interfaces

Compatible channel interfaces are set forth in Technical Reference TR-NPL-000336.

D. Optional Features and Functions

1. Telegraph Bridging (two-wire and four-wire)

The following table shows the technical specifications packages with which the optional features and functions are available.

Parameter	Available with Technical Specifications Package TG-	
	1	2
Telegraph Bridging	X	X

E7.2.3 Voice Grade (a.k.a. BellSouth SPA DS0 VG) Service^{1, 2}

(C)

A. Basic Channel Description

A Voice Grade (a.k.a. BellSouth SPA DS0 VG) channel is a channel which provides voice frequency transmission capability in the normal frequency range of 300 to 3000 Hz and may be terminated two-wire or four-wire. Voice Grade (a.k.a. BellSouth SPA DS0 VG) channels are provided between customer designated premises or between a customer designated premises and a Company Hub.

Voice Grade (a.k.a. BellSouth SPA DS0 VG) channels are classified as Voice Grade/Voice or Voice Grade/Data depending on the suitability of the technical specification package requested by the customer. Voice Grade (a.k.a. BellSouth SPA DS0 VG) technical specification packages 1, 2, 3, 4, 5, 7, 8, 9, 11 and 12 are suitable for Voice Grade/Voice. Technical specification packages 6 and 10 are suitable for Voice Grade/Data service.

Note 1: Effective September 30, 2017, Voice Grade (a.k.a. BellSouth SPA DS0 VG) service in the Kings Point, Florida Telephone Company wire center is no longer available.

Note 2: Effective June 30, 2021, this Service will no longer be available for purchase by new or existing customers. In addition, requests to move, add, change, or renew existing service arrangements will not be accepted. Following the expiration of a customer's existing term agreement, service will be provided on a month-to-month basis at the applicable Monthly rates until the service is discontinued. The Company currently plans to discontinue this service on or after June 30, 2024.

(N)
 |
 (N)

BELLSOUTH
 TELECOMMUNICATIONS
 FLORIDA
 ISSUED: June 29, 2021
 BY: Joe York, President -FL
 Jacksonville, Florida

ACCESS SERVICES TARIFF

Fourth Revised Page 11
 Cancels Third Revised Page 11

EFFECTIVE: June 30, 2021

E7. DEDICATED ACCESS SERVICES

E7.2 Service Description (Cont'd)

E7.2.3 Voice Grade (a.k.a. BellSouth SPA DS0 VG) Service^{2,3} (Cont'd)

(C)

B. Technical Specifications Packages

Parameter	VG Matrix												
	1	2	3	4	5	6	7	8	9	10	11	12	
Attenuation Distortion	X	X	X	X	X	X	X	X	X	X	X	X	X
C-Message Noise	X	X	X	X	X	X	X	X	X	X	X	X	X
Echo Control	X	X	X		X		X	X			X	X	
Envelope Delay													
Distortion						X	X	X	X	X	X	X	X
Frequency Shift						X	X	X	X	X	X	X	X
Impulse Noise					X	X	X	X	X	X	X	X	X
Intermodulation													
Distortion						X	X	X	X	X	X	X	X
Loss Deviation	X	X	X	X	X	X	X	X	X	X	X	X	X
Phase Jitter						X	X	X	X	X	X	X	X
Signal-to-C													
Message Noise				X									
Signal-to-C													
Notch Noise					X	X	X	X	X	X	X	X	X

The technical specifications for these parameters are delineated in Technical Reference TR-NPL-000335 and associated Addendum.

C. Channel Interfaces¹

The following channel interfaces for Voice Grade (a.k.a. BellSouth SPA DS0 VG) service do not require signaling capability: DA, DB, DD, DE, DS, NO, PR and TF.

- Note 1:** Channel Interface Codes are found in E7.3.1 following.
- Note 2:** Effective September 30, 2017, Voice Grade (a.k.a. BellSouth SPA DSO VG) service in the Kings Point, Florida Telephone Company wire center is no longer available.
- Note 3:** Effective June 30, 2021, this Service will no longer be available for purchase by new or existing customers. In addition, requests to move, add, change, or renew existing service arrangements will not be accepted. Following the expiration of a customer's existing term agreement, service will be provided on a month-to-month basis at the applicable Monthly rates until the service is discontinued. The Company currently plans to discontinue this service on or after June 30, 2024.

(N)
 |
 (N)

BELLSOUTH
TELECOMMUNICATIONS
FLORIDA
ISSUED: June 29, 2021
BY: Joe York, President -FL
Jacksonville, Florida

ACCESS SERVICES TARIFF

Fourth Revised Page 12
Cancels Third Revised Page 12

EFFECTIVE: June 30, 2021

E7. DEDICATED ACCESS SERVICES**E7.2 Service Description (Cont'd)****E7.2.3 Voice Grade (a.k.a. BellSouth SPA DS0 VG) Service^{5, 6} (Cont'd)**

(C)

C. Channel Interfaces¹(Cont'd)

The following channel interfaces for Voice Grade (a.k.a. BellSouth SPA DS0 VG) service require signaling capability: AB, AC, CT, DX, EA, EB, EC, EX, GO, GS, LA, LB, LC, LO, LR, LS, RV and SF.

Compatible channel interfaces are set forth in Technical Reference TR-NPL-000054 and Associated Addendum.

D. Optional Features and Functions

1. Central Office Bridging Capability

- a. Voice Bridging² (two-wire and four-wire)
- b. Data Bridging³ (two-wire and four-wire)
- c. Telephoto Bridging⁴ (two-wire and four-wire)
- d. Dataphone[®] Select-A-Station Bridging with sequential arrangement ports or addressable arrangement ports
- e. Telemetry and Alarm Bridging
 - Split Band, Active Bridging

2. Conditioning

Conditioning provides more specific transmission characteristics for Voice Grade (a.k.a. BellSouth SPA DS0 VG) services. C-Type conditioning controls attenuation distortion and envelope delay distortion. Sealing Current helps maintain continuity on dry metallic⁶ loops.

(C)

In addition, a customer may desire that either the attenuation distortion or the envelope delay distortion, or both, be improved to more stringent specifications than those provided for C-Type conditioning. In such cases the customer has the option of ordering Improved Attenuation Distortion and/or Improved Envelope Delay Distortion.

For two-point services, the parameters apply to each service. For multipoint services, the parameters apply to each mid link or end link. C-Type conditioning and D-Conditioning may be combined on the same service.

a. C-Type Conditioning

C-Type Conditioning is provided for the additional control of attenuation distortion and envelope delay distortion on data services. The attenuation distortion and envelope delay distortion specifications for C-Type Conditioning are:

Note 1: Channel Interface Codes are found in E7.3.1 following.

Note 2: Voice Bridging is intended for use with VG2, 5, and 12, however, it may be used on VG6 and VG10 at a customer's request.

Note 3: Data Bridging is intended for use with VG6 and VG10, however, it may be used on VG2, 5, and 12 at a customer's request.

Note 4: Telephoto Bridging is intended for use on VG-11.

Note 5: Effective September 30, 2017, Voice Grade (a.k.a. BellSouth SPA DSO VG) service in the Kings Point, Florida Telephone Company wire center is no longer available.

Note 6: Effective June 30, 2021, this Service will no longer be available for purchase by new or existing customers. In addition, requests to move, add, change, or renew existing service arrangements will not be accepted. Following the expiration of a customer's existing term agreement, service will be provided on a month-to-month basis at the applicable Monthly rates until the service is discontinued. The Company currently plans to discontinue this service on or after June 30, 2024.

(N)

(N)

BELLSOUTH
 TELECOMMUNICATIONS
 FLORIDA
 ISSUED: June 29, 2021
 BY: Joe York, President -FL
 Jacksonville, Florida

ACCESS SERVICES TARIFF

Fourth Revised Page 13
 Cancels Third Revised Page 13

EFFECTIVE: June 30, 2021

E7. DEDICATED ACCESS SERVICES

E7.2 Service Description (Cont'd)

E7.2.3 Voice Grade (a.k.a. BellSouth SPA DS0 VG) Service^{1, 2} (Cont'd)

(C)

D. Optional Features and Functions (Cont'd)

2. Conditioning (Cont'd)

a. C-Type Conditioning (Cont'd)

Attenuation Distortion (Frequency Response) Relative to 1004 Hz

Frequency Range (Hz)	Variation (dB)
504 - 2804	-1.0 to + 3.0
304 - 3004	- 2.0 to + 6.0

Envelope Delay Distortion

Frequency Range (Hz)	Variation (micro-seconds)
1004 - 2604	Less Than 501
604 - 2604	Less Than 1501
504 - 2804	Less Than 3001

b. Improved Attenuation Distortion

Improved attenuation distortion is provided for additional control of attenuation distortion. The improved attenuation distortion specifications are:

Attenuation Distortion (Frequency Response) Relative to 1004 Hz

Frequency Range (Hz)	Variation (dB)
404-2804	-1.0 to +2.0
304-3004	-1.0 to +3.0
3004-3204	-2.0 to +6.0

c. Improved Envelope Delay Distortion

Improved envelope delay distortion is provided for additional control of envelope distortion. The improved envelope delay distortion specifications are:

Envelope Delay Distortion

Frequency Range (Hz)	Variation (micro-seconds)
1001-2604	Less Than 101
604-2604	Less Than 301
504-2804	Less Than 3001

Note 1: Effective September 30, 2017, Voice Grade (a.k.a. BellSouth SPA DSO VG) service in the Kings Point, Florida Telephone Company wire center is no longer available.

Note 2: Effective June 30, 2021, this Service will no longer be available for purchase by new or existing customers. In addition, requests to move, add, change, or renew existing service arrangements will not be accepted. Following the expiration of a customer's existing term agreement, service will be provided on a month-to-month basis at the applicable Monthly rates until the service is discontinued. The Company currently plans to discontinue this service on or after June 30, 2024.

(N)
 |
 (N)

BELLSOUTH
TELECOMMUNICATIONS
FLORIDA
ISSUED: June 29, 2021
BY: Joe York, President -FL
Jacksonville, Florida

ACCESS SERVICES TARIFF

Fourth Revised Page 14
Cancels Third Revised Page 14

EFFECTIVE: June 30, 2021

E7. DEDICATED ACCESS SERVICES**E7.2 Service Description (Cont'd)****E7.2.3 Voice Grade (a.k.a. BellSouth SPA DS0 VG) Service^{1,2} (Cont'd)**

(C)

D. Optional Features and Functions (Cont'd)

2. Conditioning (Cont'd)

d. Sealing Current Conditioning

Sealing Current Conditioning is provided to help maintain continuity on dry metallic² loops. It is usually associated with four-wire DA or NO type channel interfaces.

(C)

3. Customer Specified Premises Receive Level

This option allows the customer to specify the receive level at the Point of Termination. The level must be within a specific range of effective four-wire transmission. The ranges are delineated in Technical Reference TR-NPL-000335.

4. Echo Control

a. Improved Return Loss

On Effective Two-Wire Transmission at Two-Wire Point of Termination: Provides for more stringent Echo Control specifications. In order for this option to be applicable, the transmission path must be four-wire at one POT and two-wire at the other POT. Placement of Company equipment may be required at the customer's premises with the two-wire POT. The Improved Return Loss parameters are delineated in Technical Reference TR-NPL-000335.

b. ELEPL 2 (Equal Level Echo Path Loss)

Specified at the Four-Wire Point of Termination and provides for more stringent Echo Control. In order for this option to be applicable, the interface must be two-wire at one Point of Termination (POT) and four-wire at the other POT. The ELEPL 2 parameters are delineated in Technical Reference TR-NPL-000335.

5. D-Conditioning

D-Conditioning provides transmission characteristics suitable for data communications. Specifically, D-Conditioning provides for the control of Signal to C-Notched Noise Ratio and intermodulation distortion. It is available for two-point services or multipoint services. This option is available for use with Technical Specification Packages VG6, VG7 and VG10 on Two-Point Multipoint Services. (However, it is not recommended for use with Multipoint.)

D-Conditioning transmission characteristics are described in Technical Reference TR-NPL-000335 under the name Data Capability.

The signal to C-Notched Noise Ratio and intermodulation distortion parameters for D-Conditioning are:

- Signal to C-Notched Noise Ratio is equal to or greater than 32dB

- Intermodulation distortion:

- Signal to second order modulation products (R2) is equal to or greater than 38dB

- Signal to third order modulation products (R3) is equal to or greater than 42dB

Note 1: Effective September 30, 2017, Voice Grade (a.k.a. BellSouth SPA DSO VG) service in the Kings Point, Florida Telephone Company wire center is no longer available.

Note 2: Effective June 30, 2021, this Service will no longer be available for purchase by new or existing customers. In addition, requests to move, add, change, or renew existing service arrangements will not be accepted. Following the expiration of a customer's existing term agreement, service will be provided on a month-to-month basis at the applicable Monthly rates until the service is discontinued. The Company currently plans to discontinue this service on or after June 30, 2024.

(N)

(N)

BELLSOUTH
 TELECOMMUNICATIONS
 FLORIDA
 ISSUED: June 29, 2021
 BY: Joe York, President -FL
 Jacksonville, Florida

ACCESS SERVICES TARIFF

Fourth Revised Page 15
 Cancels Third Revised Page 15

EFFECTIVE: June 30, 2021

E7. DEDICATED ACCESS SERVICES

E7.2 Service Description (Cont'd)

E7.2.3 Voice Grade (a.k.a. BellSouth SPA DS0 VG) Service^{1,2} (Cont'd)

(C)

D. Optional Features and Functions (Cont'd)

5. D-Conditioning (Cont'd)

When a service equipped with D-Conditioning and is used for voice communications, the quality of the voice transmission may not be satisfactory.

6. Telephoto Conditioning

Telephoto Conditioning provides transmission characteristics suitable for telephotographic communications. Specifically, Telephoto Conditioning is provided for the control of attenuation distortion and envelope delay distortion parameters for Telephoto Conditioning are:

Attenuation Distortion

(2204 Hz Reference)

Frequency Variation

Range (Hz) Variation (dB)

304 - 3204 - 1.0 to + 2.5

504 - 3004 - 0.5 to + 1.5

Envelope Delay Distortion

Frequency Variation

Range (Hz) Variation (mcs)

1004 - 2604 Less Than 111

804 - 2804 Less Than 181

7. Signaling Capability

Signaling Capability provides for the process by which one customer premises alerts another customer premises on the same service with which it wishes to communicate.

8. Improved Termination

The Improved Termination option provides a fixed 600 ohm impedance, a variable level range and simplex reversal, when applicable, at the point of termination. Company equipment is required at the customer's premises when this option is ordered. The Improved Termination parameters are delineated in Technical Reference TR-NPL-000335.

9. Simplex Reversal

The Simplex Reversal option physically turns over the simplex DC path presented at the four-wire point of termination when LO, LS, GO, GS, & DX signaling is provided at the point of termination.

10. FlexServ Service (a.k.a. BellSouth SPA Customer Reconfiguration)

FlexServ service (a.k.a. BellSouth SPA Customer Reconfiguration) provides the customer the ability to monitor and reconfigure Voice Grade (a.k.a. BellSouth SPA DS0 VG) service provided by the Company. FlexServ service (a.k.a. BellSouth SPA Customer Reconfiguration) is described in E7.4.12 following. Charges for this feature are contained in E7.5.16. following.

Note 1: Effective September 30, 2017, Voice Grade (a.k.a. BellSouth SPA DSO VG) service in the Kings Point, Florida Telephone Company wire center is no longer available.

Note 2: Effective June 30, 2021, this Service will no longer be available for purchase by new or existing customers. In addition, requests to move, add, change, or renew existing service arrangements will not be accepted. Following the expiration of a customer's existing term agreement, service will be provided on a month-to-month basis at the applicable Monthly rates until the service is discontinued. The Company currently plans to discontinue this service on or after June 30, 2024.

(N)
 |
 (N)

BELLSOUTH
 TELECOMMUNICATIONS
 FLORIDA
 ISSUED: June 29, 2021
 BY: Joe York, President -FL
 Jacksonville, Florida

ACCESS SERVICES TARIFF

Fourth Revised Page 16
 Cancels Third Revised Page 16

EFFECTIVE: June 30, 2021

E7. DEDICATED ACCESS SERVICES

E7.2 Service Description (Cont'd)

E7.2.3 Voice Grade (a.k.a. BellSouth SPA DS0 VG) Service^{1,2} (Cont'd)

(C)

D. Optional Features and Functions (Cont'd)

The following table shows the technical specifications packages with which the optional features and functions are available.

	Available with Technical Specifications Package VG-											
	1	2	3	4	5	6	7	8	9	10	11	12
C-Type Conditioning					X	X	X	X	X	X		
Improved Attenuation												
Distortion					X	X	X	X	X	X		
Improved Envelope												
Delay Distortion					X	X	X	X	X	X		
Sealing Current												
Conditioning							X					
D-Conditioning							X	X		X		
Central Office												
Bridging		X			X	X				X	X	X
Customer Specified												
Premises Receive												
Level		X	X				X	X	X			
Echo Control												
Improved Return												
Loss		X	X				X					
ELEPL2	X	X	X		X		X					
FlexServ Service (a.k.a. BellSouth SPA Customer Reconfiguration)	X	X	X	X	X	X	X	X	X	X	X	X
Improved Termination	X	X	X	X	X	X	X	X	X	X	X	X
Simplex Reversal	X	X	X				X	X	X			
Signaling Capability	X	X	X				X	X	X			
Telephoto												
Conditioning											X	

Note 1: Effective September 30, 2017, Voice Grade (a.k.a. BellSouth SPA DSO VG) service in the Kings Point, Florida Telephone Company wire center is no longer available.

Note 2: Effective June 30, 2021, this Service will no longer be available for purchase by new or existing customers. In addition, requests to move, add, change, or renew existing service arrangements will not be accepted. Following the expiration of a customer's existing term agreement, service will be provided on a month-to-month basis at the applicable Monthly rates until the service is discontinued. The Company currently plans to discontinue this service on or after June 30, 2024.

(N)

(N)

BELLSOUTH
TELECOMMUNICATIONS
FLORIDA

ACCESS SERVICES TARIFF

Fourth Revised Page 17
Cancels Third Revised Page 17

ISSUED: June 29, 2021
BY: Joe York, President -FL
Jacksonville, Florida

EFFECTIVE: June 30, 2021

E7. DEDICATED ACCESS SERVICES

E7.2 Service Description (Cont'd)

E7.2.3 Voice Grade (a.k.a. BellSouth SPA DS0 VG) Service^{1, 2} (Cont'd)

(C)

E. Four-Wire/Two-Wire Conversions

When a customer requests that an effective four-wire channel be terminated with a two-wire channel interface at the customer designated premises, a four-wire to two-wire conversion of the four-wire local channel is required. The rate for the conversion is included as part of the basic Local Channel rate.

E7.2.4 Reserved for Future Use

E7.2.5 Digital Data Access² (a.k.a. BellSouth SPA DS0 Digital Data) Service

(C)

A. Basic Channel Description

A Digital Data (a.k.a. BellSouth SPA DS0 Digital Data) channel is a channel for four-wire transmission of synchronous serial data at the rate of 2.4, 4.8, 9.6, 19.2, 56, or 64 Kbps. The actual bit rate is a function of the channel interface and channel selected by the customer. The channel provides a synchronous service with timing provided by the Company through the Company's facilities to the customer in the received bit stream. Digital Data (a.k.a. BellSouth SPA DS0 Digital Data) channels are only available via Company designated Digital Data (a.k.a. BellSouth SPA DS0 Digital Data) Hubs and are provided between customer designated premises or between a customer designated premises and a Company Digital Data (a.k.a. BellSouth SPA DS0 Digital Data) Hub.

A Hub Termination Charge applies per Digital Data (a.k.a. BellSouth SPA DS0 Digital Data) Local Channel. This rate element covers the Hub functions (e.g., Timing, Testing) for the service.

Secondary Channel Capability (SCC) is a derived companion digital transmission path that is independent of the primary data path and operates at a substantially lower bit rate. This derived channel allows the customer to perform network management functions during the normal operation of the network. This diagnostics channel utilizes a portion of a customer's previously unavailable data bit stream allowing for the ability to remotely control and test the network and peripheral devices without taking the network out of service. Special customer equipment is necessary to utilize the benefits of the Secondary Channel. Customers not wishing to utilize this capability will not be impacted. Due to transmission equipment restrictions. Secondary Channel cannot be provided on 56 Kbps circuits that require the installation of loop repeater equipment for provision of service. Secondary Channel Capability, also, cannot be provided on 64 Kbps circuits, since all of the available bit stream will be used by the customer.

The customer may provide the Channel Service Unit-type equipment or other Network Channel Terminating Equipment associated with the Digital Data (a.k.a. BellSouth SPA DS0 Digital Data) channel at the customer premises. The interim program for interconnection of such equipment is set forth in Technical Reference PUB AS No. 1.

Note 1: Effective September 30, 2017, Voice Grade (a.k.a. BellSouth SPA DSO VG) service in the Kings Point, Florida Telephone Company wire center is no longer available.

Note 2: Effective June 30, 2021, this Service will no longer be available for purchase by new or existing customers. In addition, requests to move, add, change, or renew existing service arrangements will not be accepted. Following the expiration of a customer's existing term agreement, service will be provided on a month-to-month basis at the applicable Monthly rates until the service is discontinued. The Company currently plans to discontinue this service on or after June 30, 2024.

(N)

(N)

BELLSOUTH
 TELECOMMUNICATIONS
 FLORIDA
 ISSUED: June 29, 2021
 BY: Joe York, President -FL
 Jacksonville, Florida

ACCESS SERVICES TARIFF

Second Revised Page 18
 Cancels First Revised Page 18

EFFECTIVE: June 30, 2021

E7. DEDICATED ACCESS SERVICES

E7.2 Service Description (Cont'd)

E7.2.5 Digital Data Access³ (a.k.a. BellSouth SPA DS0 Digital Data) Service (Cont'd)

(C)

B. Technical Specifications Packages

Parameter	DA Matrix					
	1	2	3	4	5	6
Error-Free Seconds	X	X	X	X	X	X

The Company will provide a channel capable of meeting a monthly average performance equal to or greater than 99.875 percent error-free seconds¹ while the channel is in service, if it is measured through a CSU equivalent which is designed, manufactured, and maintained to conform with the interconnection specifications contained in Technical Reference PUB 62310.

Interface options and service objectives are as specified in Technical Reference TR-NPL-000341.

C. Channel Interfaces

The following channel interfaces (CIs) define the bit rates that are available for a Digital Data (a.k.a. BellSouth SPA DS0 Digital Data) channel:

CI	Bit Rate
DU-24(S) ²	2.4 Kbps
DU-48(S) ²	4.8 Kbps
DU-96(S) ²	9.6 Kbps
DU-19(S) ²	19.2 Kbps
DU-56(S) ²	56.0 Kbps
DU-64	64.0 Kbps

Compatible channel interfaces are set forth in Technical Reference TR-NPL-000341.

D. Optional Features and Functions

1. Central Office Bridging Capability
2. Secondary Channel Capability
3. FlexServ[®] Service (a.k.a. BellSouth SPA Customer Reconfiguration)

FlexServ[®] service (a.k.a. BellSouth SPA Customer Reconfiguration) provides the customer the ability to monitor and reconfigure Digital Data Access (a.k.a. BellSouth SPA DS0 Digital Data) service provided by the Company. FlexServ[®] service (a.k.a. BellSouth SPA Customer Reconfiguration) is described in E7.4.12 following. Charges for this feature are contained in E7.5.16. following.

Note 1: This channel performance does not apply when the Data Over Voice Channel option is used.

Note 2: (S) is an additional BellSouth designation for use when the optional Secondary Channel feature is required.

Note 3: Effective June 30, 2021, this Service will no longer be available for purchase by new or existing customers. In addition, requests to move, add, change, or renew existing service arrangements will not be accepted. Following the expiration of a customer's existing term agreement, service will be provided on a month-to-month basis at the applicable Monthly rates until the service is discontinued. The Company currently plans to discontinue this service on or after June 30, 2024.

(N)
 |
 (N)

BELLSOUTH
 TELECOMMUNICATIONS
 FLORIDA
 ISSUED: June 29, 2021
 BY: Joe York, President -FL
 Jacksonville, Florida

ACCESS SERVICES TARIFF

Third Revised Page 19
 Cancels Second Revised Page 19

EFFECTIVE: June 30, 2021

E7. DEDICATED ACCESS SERVICES

E7.2 Service Description (Cont'd)

E7.2.5 Digital Data Access¹ (a.k.a. BellSouth SPA DS0 Digital Data) Service (Cont'd)

(C)

- D. Optional Features and Functions (Cont'd)
- 4.

The following table shows the technical specifications packages with which the optional features and functions are available.

	Available with Technical Specifications Package DA-					
	1	2	3	4	5	6
Central Office Bridging Capability	X	X	X	X	X	
Secondary Channel Capability	X	X	X	X	X	
FlexServ [®] Service (a.k.a. BellSouth SPA Customer Reconfiguration)	X	X	X	X	X	X

Note 1: Effective June 30, 2021, this Service will no longer be available for purchase by new or existing customers. In addition, requests to move, add, change, or renew existing service arrangements will not be accepted. Following the expiration of a customer's existing term agreement, service will be provided on a month-to-month basis at the applicable Monthly rates until the service is discontinued. The Company currently plans to discontinue this service on or after June 30, 2024.

(N)
 |
 (N)

BELLSOUTH
 TELECOMMUNICATIONS
 FLORIDA
 ISSUED: June 29, 2021
 BY: Joe York, President -FL
 Jacksonville, Florida

ACCESS SERVICES TARIFF

Second Revised Page 20
 Cancels First Revised Page 20

EFFECTIVE: June 30, 2021

E7. DEDICATED ACCESS SERVICES

E7.2 Service Description (Cont'd)

E7.2.6 High Capacity (a.k.a. BellSouth SPA High Capacity) Service

A. Basic Channel Description

A High Capacity (*a.k.a. BellSouth SPA High Capacity*) channel is a channel for the transmission of nominal 64.0 Kbps^{1, 2} or 1.544, 3.152, 6.312, or 44.736 Mbps isochronous serial data. The actual bit rate is a function of the channel interface selected by the customer. High Capacity (*a.k.a. BellSouth SPA High Capacity*) channels are provided between customer designated premises or between a customer designated premises and a Company Hub. (C)

The customer may provide the Network Channel Terminating Equipment associated with the High Capacity (*a.k.a. BellSouth SPA High Capacity*) channel at the customer's premises. The interim program for interconnection of such equipment is set forth in Technical Reference PUB AS No. 1.

B. Technical Specifications Packages

Parameters	HC Matrix			
	0	1	1C	2 3
Error-Free Seconds		X		

A channel with technical specifications package HC1 will be capable of an error-free second performance of 98.75 percent over a continuous 24 hour period as measured at the 1.544 Mbps rate through a CSU equivalent which is designed to conform with the interconnection specifications contained in Technical Reference PUB 62411.

Further technical specifications are delineated in Technical Reference TA-TSY-000342.

C. Channel Interfaces

The following channel interfaces (CIs) define the bit rates that are available for a High Capacity (*a.k.a. BellSouth SPA High Capacity*) channel:

CI	Bit Rate
DS-15 ²	1.544 Mbps (DS1)
DS-31	3.152 Mbps (DS1C)
DS-44	44.736 Mbps (DS3)
DS-63	6.312 Mbps (DS2)

Compatible channel interfaces are set forth in Technical Reference TR-TSY-000342.

Note 1: Available only as a cross connect (through connection) of two 2.4, 4.8, 9.6, 19.2, 56.0 or 64.0 Kbps channels of two 1.544 Mbps facilities to a Digital Data (*a.k.a. BellSouth SPA DSO Digital Data*) Hub(s). The customer must provide system and channel assignment data.

Note 2: Effective June 30, 2021, 64.0 Kbps will no longer be available for purchase by new or existing customers. In addition, requests to move, add, change, or renew existing service arrangements will not be accepted. Following the expiration of a customer's existing term agreement, service will be provided on a month-to-month basis at the applicable Monthly rates until the service is discontinued. The Company currently plans to discontinue this service on or after June 30, 2024. (N)

BELLSOUTH
TELECOMMUNICATIONS
FLORIDA
ISSUED: June 29, 2021
BY: Joe York, President -FL
Jacksonville, Florida

ACCESS SERVICES TARIFF

Third Revised Page 21
Cancels Second Revised Page 21

EFFECTIVE: June 30, 2021

E7. DEDICATED ACCESS SERVICES**E7.2 Service Description (Cont'd)****E7.2.6 High Capacity (a.k.a. BellSouth SPA High Capacity) Service (Cont'd)**

D. Optional Features and Functions

1.

2. Channelization

a. DS3 to DS1

An arrangement that channelizes a 44.736 Mbps channel to 28 DS1 channels.

b. DS2 to DS1

An arrangement that channelizes a 6.312 Mbps channel to four DS1 channels.

c. DS1C to DS1

An arrangement that channelizes a 3.152 Mbps channel to two DS1 channels

d. DS1 Basic Channelization System

An arrangement that channelizes a 1.544 Mbps channel to a maximum of twenty four 64 Kbps channels. A channel of this DS1 to the Hub can also be used for a Digital Data service. A DS1 Basic Channelization System requires a Central Office Channel Interface for each channel of lesser capacity.

e. DS0 Basic Channelization System¹

An arrangement that channelizes a 64.0 Kbps channel to a subspeeds of up to twenty 2.4 Kbps, ten 4.8 Kbps, or five 9.6 Kbps channels. A DS0 Basic Channelization System requires a Central Office Channel Interface for each channel of lesser capacity.

(C)

3. Channel Interface

a. DS1 Level Central Office Channel Interface

An arrangement for the connection of DS1 (1.544 Mbps) channels of higher order DS3 (44.736 Mbps) services, in Company central office locations.

b. DS1 Level Customer Channel Interface

An arrangement for the connection of DS1 (1.544 Mbps) channels to higher order DS3 (44.736 Mbps) services, at customer locations.

c. DS0 Level Central Office Channel Interface¹

An arrangement for the connection of VG/DS0 (2.4 - 64.0 Kbps) channels to higher order DS1 (1.544 Mbps) services, in Company central office locations.

(C)

Note 1: Effective June 30, 2021, this Service will no longer be available for purchase by new or existing customers. In addition, requests to move, add, change, or renew existing service arrangements will not be accepted. Following the expiration of a customer's existing term agreement, service will be provided on a month-to-month basis at the applicable Monthly rates until the service is discontinued. The Company currently plans to discontinue this service on or after June 30, 2024.

(N)

(N)

E7. DEDICATED ACCESS SERVICES

E7.2 Service Description (Cont'd)

E7.2.6 High Capacity (a.k.a. BellSouth SPA High Capacity) Service (Cont'd)

D. Optional Features and Functions (Cont'd)

3. Channel Interface (Cont'd)

d. Subrate Level Central Office Channel Interface²

An arrangement for the connection of subrate (2.4 - 9.6 Kbps) channels to higher order DS0 (64.0 Kbps) services, in Company central office locations.

(C)

4. Clear Channel Capability

a. Clear Channel Capability (CCC) is an arrangement that alters a DS1/1.544 Mbps signal with unconstrained information bits, to meet pulse density requirements outlined in TR-NPL-000054 and TA-TSY-000342. This will allow a customer to transport an all zero octet over a DS1/1.544 Mbps High Capacity (a.k.a. **BellSouth SPA DS1**) channel, providing an available combined maximum 1.536 Mbps data rate. This arrangement requires the customer signal at the channel interface to conform to Bipolar with 8 Zero Substitution (B8ZS) line code as described in TR-NPL-000054 and TA-TSY-000342.

b. CCC is provided on DS1/1.544 Mbps High Capacity (a.k.a. **BellSouth SPA DS1**) channels between two customer designated premises, or between a customer designated premises and a Company Hub location, and is subject to the availability of facilities. This optional feature may be ordered at the same time the DS1/1.544 Mbps High Capacity (a.k.a. **BellSouth SPA DS1**) channel is ordered, or it may be ordered as an additional feature of an existing channel.

c. When providing CCC via a DS3/44.736 Mbps High Capacity (a.k.a. **BellSouth SPA DS3**) channel, that DS3 channel must be designated, in Company records, as having Clear Channel Capability prior to the provisioning of a DS1/1.544 Mbps High Capacity (a.k.a. **BellSouth SPA DS1**) channel with CCC. Customers must agree to out-of-service periods required to add this feature to; 1) an existing DS1/1.544 Mbps High Capacity (a.k.a. **BellSouth SPA DS3**) channel or 2) a DS3/44.736 Mbps High Capacity (a.k.a. **BellSouth SPA DS3**) channel which transports a DS1/1.544 Mbps High Capacity (a.k.a. **BellSouth SPA DS1**) channel, to be optioned for B8ZS.

5. FlexServ[®] Service (a.k.a. **BellSouth SPA Customer Reconfiguration**)

FlexServ[®] service (a.k.a. **BellSouth SPA Customer Reconfiguration**) provides the customer the ability to monitor and reconfigure High Capacity (a.k.a. **BellSouth SPA High Capacity**) service provided by the Company. FlexServ[®] service (a.k.a. **BellSouth SPA Customer Reconfiguration**) is described in E7.4.12 following. Charges for this feature are contained in E7.5.16. following.

The following table shows the technical specifications packages with which the optional features and functions are available.

Available With Technical Specifications Package HC-0 1 1C 2 3

Channelization:				
DS3 to DS1				X
DS2 to DS1			X	
DS1C to DS1		X		
DS1 Basic Channelization System	X			
DS0 Basic Channelization System ^{1,2}	X			
Clear Channel Capability		X		
FlexServ [®] Service (a.k.a. BellSouth SPA Customer Reconfiguration)	X	X		

(C)

Note 1: Available only on 64 Kbps DDAS (a.k.a. **BellSouth SPA DS0 Digital Data**) service or on a DS1 (1.544 Mbps) channel with Clear Channel Capability to a Company Hub.

Note 2: Effective June 30, 2021, this Service will no longer be available for purchase by new or existing customers. In addition, requests to move, add, change, or renew existing service arrangements will not be accepted. Following the expiration of a customer's existing term agreement, service will be provided on a month-to-month basis at the applicable Monthly rates until the service is discontinued. The Company currently plans to discontinue this service on or after June 30, 2024.

(N)
 |
 (N)

BELLSOUTH
TELECOMMUNICATIONS
FLORIDA

ACCESS SERVICES TARIFF

Third Revised Page 23
Cancels Second Revised Page 23

ISSUED: November 30, 2021
BY: Joe York, President -FL
Jacksonville, Florida

EFFECTIVE: December 1, 2021

E7. DEDICATED ACCESS SERVICES

E7.2 Service Description (Cont'd)

E7.2.7 Reserved for Future Use

E7.2.8 Reserved for Future Use

E7.2.9 Reserved for Future Use

E7.2.10 Reserved for Future Use

E7.2.11 Reserved for Future Use

E7.2.12 SMARTPath[®] Service (a.k.a. BellSouth SPA Shared Ring)

A. Service Description

SMARTPath[®] service (a.k.a. BellSouth SPA Shared Ring) is a shared high capacity network service capable of providing a 1.544 Mbps transport link with high performance and reliability parameters and a level of redundancy/diversity designed to limit a single event from interrupting service. This service is available only in those locations within specified SMARTPath[®] service (a.k.a. BellSouth SPA Shared Ring) Areas which the Company determines can be incorporated into the SMARTPath[®] service (a.k.a. BellSouth SPA Shared Ring) network enabling the Company to provide the specified level of performance and reliability. For locations where a customer requests SMARTPath[®] service (a.k.a. BellSouth SPA Shared Ring) and facilities are not available, special construction charges will apply as set forth in Section E14. following. SMARTPath[®] service (a.k.a. BellSouth SPA Shared Ring) Areas are identified in the NATIONAL EXCHANGE CARRIER (NECA) TARIFF F.C.C. No.4.

SMARTPath[®] service (a.k.a. BellSouth SPA Shared Ring) provides a transport link between a customer designated premises where the network is accessed and (1) another customer designated premises, in the same SMARTPath[®] service (a.k.a. BellSouth SPA Shared Ring) Area or (2) a serving wire center in the same SMARTPath[®] service (a.k.a. BellSouth SPA Shared Ring) Area for connection to (a) DS1 Basic Channelization, FlexServ[®] service (a.k.a. BellSouth SPA Customer Reconfiguration), SmartRing[®] service (a.k.a. BellSouth Dedicated Ring), or DS3 service as provided in Section E7. of this Tariff, BellSouth Virtual Expanded Interconnection Services under Section E20. of this Tariff, or (b) a SMARTPath[®] service (a.k.a. BellSouth SPA Shared Ring) Area Junction of another SMARTPath[®] service (a.k.a. BellSouth SPA Shared Ring) area in the same Metropolitan Area.

(C)

Note 1: Effective on or after December 1, 2021, neither new nor existing customers will be permitted to purchase new SMARTRing Service (Service). In addition, (A) Service Payment Plans greater than 12-months in length will no longer be available; and (B) requests to move, add, change, upgrade, or downgrade existing service arrangements will not be accepted, with the following exceptions: (1) existing customers will be permitted to modify their existing Service and will be able to add new circuits to their existing Service, but will not be permitted to add new nodes in any locations; and (2) any such new circuits will be subject to the customer's existing term payment plan or term agreement for the Service to which they are added. Following the expiration of a customer's existing term agreement, Service will be provided on a month-to-month basis at the applicable Month-to-Month rates until the Service is discontinued.

(N)

Effective November 30, 2023, unless specified to the contrary in their existing Service agreements, existing customers may not renew Term Payment Plans or term agreements for Service. In addition, no move, add, or change orders of any type will be accepted.

(N)

BELLSOUTH
TELECOMMUNICATIONS, INC.
FLORIDA

ACCESS SERVICES TARIFF

Third Revised Page 24
Cancels Second Revised Page 24

ISSUED: December 22, 1998
BY: Joseph P. Lacher, President -FL
Miami, Florida

EFFECTIVE: January 6, 1999

E7. DEDICATED ACCESS SERVICES

E7.2 Service Description (Cont'd)

E7.2.12 SMARTPath® Service (a.k.a. BellSouth SPA Shared Ring) (Cont'd)

A. Service Description (Cont'd)

The technical specifications and standard network interfaces for SMARTPath® service (a.k.a. BellSouth SPA Shared Ring) are contained in BellSouth Telecommunications, Inc. Technical Reference Publication 73575. This publication is available from BellSouth Services Documentation Operations, North W5A1, 3535 Colonnade Parkway, Birmingham, Alabama 35243.

DS1s carried over Synchronous Optical Network (SONET) transport systems can incur phase transients as a result of pointer adjustments. In some instances timing problems could surface in customer's equipment with Stratum 3 or better clocks. This may result in the customer's clock disqualifying its synchronization reference, generating an alarm and/or selecting an alternate reference or entering holdover. To insure proper operation, channelized DS1 circuits must comply with Bellcore Technical Advisory, TA-NWT-000436, Digital Synchronization Network Plan, and ANSI T1.101-1994. When timing is taken from a Company transported DS1, the customer's equipment must be capable of accommodating SONET pointer adjustments.

B. Performance Objectives

ANSI T1.403-1989 Extended SuperFrame Format (ESF) is required on all circuits in order to assure performance objectives. The performance objectives for SMARTPath® service (a.k.a. BellSouth SPA Shared Ring) are as follows:

1. Meet or exceed 99.99 percent Circuit Availability on a monthly basis. This objective applies except where a customer's equipment is disconnected and/or inoperative.
2. Meet or exceed 99.95 percent Error Free Seconds on a monthly basis.
3. Meet or exceed .009 percent Severely Errored Seconds on a monthly basis.

C. Performance Guarantee

The performance guarantee for SMARTPath® service (a.k.a. BellSouth SPA Shared Ring) is as follows:

1. Service Continuity - in the event of primary facility failure, service is guaranteed to switch to an alternate facility path in sixty (60) seconds or less. Failure to meet this guarantee will result in a credit as described in E2.4.4.B.7. preceding, where the trouble is in the network.

(M)

Material previously appearing on this page now appears on page(s) 24.1 of this section.

® Registered Service Mark of BellSouth Corporation

BELLSOUTH
TELECOMMUNICATIONS
FLORIDA
ISSUED: October 10, 2014
BY: Joe York, President -FL
Jacksonville, Florida

ACCESS SERVICES TARIFF

Second Revised Page 24.1
Cancels First Revised Page 24.1

EFFECTIVE: October 11, 2014

E7. DEDICATED ACCESS SERVICES

E7.2 Service Description (Cont'd)

E7.2.13 Reserved for Future Use

(T)

E7.2.14 Reserved for Future Use

(T)

BELLSOUTH
TELECOMMUNICATIONS, INC.
FLORIDA

ACCESS SERVICES TARIFF

Third Revised Page 25
Cancels Second Revised Page 25

ISSUED: November 30, 2001
BY: Joseph P. Lacher, President -FL
Miami, Florida

EFFECTIVE: December 30, 2001

E7. DEDICATED ACCESS SERVICES

E7.2 Service Description (Cont'd)

E7.2.14 (DELETED)

(D)

BELLSOUTH
 TELECOMMUNICATIONS
 FLORIDA
 ISSUED: June 29, 2021
 BY: Joe York, President -FL
 Jacksonville, Florida

ACCESS SERVICES TARIFF

Third Revised Page 26
 Cancels Second Revised Page 26

EFFECTIVE: June 30, 2021

E7. DEDICATED ACCESS SERVICES

E7.2 Service Description (Cont'd)

E7.2.14 (DELETED)

E7.2.15 Derived Data Channel¹ (a.k.a. BellSouth SPA Derived Data Channel) Service

A. Basic Service Description

Derived Data Channel (a.k.a. BellSouth SPA Derived Data Channel) service (DDCS) provides full-duplex asynchronous or synchronous data transmission utilizing data over voice and subrate¹ multiplexing technology. DDCS (a.k.a. BellSouth SPA Derived Data Channel) provides simultaneous data and voice transmissions over the customer's existing two-wire local exchange facility. A derived data channel is provided between the customer's premises and the customer's serving wire center. (C)

At the customer's serving wire center the data/voice terminating equipment provides subrate¹ multiplexing into a standard DS0-B interface for a group composed of a maximum of twenty derived data channels. The customer's derived data channel must be associated with a DS0-B interface. This association requires coordination between the subscriber of the derived data channel and the subscriber of the DS0-B interface. An interoffice channel is provided for interconnection of the subrate¹ multiplexed DS0-B interface to the serving wire center of a customer designated premises. (C)

DDCS (a.k.a. BellSouth SPA Derived Data Channel) is provided subject to the availability of appropriate network facilities and equipment and subject to the transmission limitations of the facilities and equipment used by the Company. (C)

The customer will be responsible for selecting his own Customer Premises Equipment (CPE). CPE must be compatible with the Company provided terminating equipment at the serving wire center.

B. Channel Interfaces

The following channel interface (CI) is available for DDCS (a.k.a. BellSouth SPA Derived Data Channel).

CI	Bit Rate	
2DV5.BA	2.4 Kbps, Digital Data Over Voice ¹	(C)

Note 1: Effective June 30, 2021, this Service will no longer be available for purchase by new or existing customers. In addition, requests to move, add, change, or renew existing service arrangements will not be accepted. Following the expiration of a customer's existing term agreement, service will be provided on a month-to-month basis at the applicable Monthly rates until the service is discontinued. The Company currently plans to discontinue this service on or after June 30, 2024. (N)

E7. DEDICATED ACCESS SERVICES**E7.2 Service Description (Cont'd)****E7.2.15 Derived Data Channel⁽²⁾ (a.k.a. BellSouth SPA Derived Data Channel) Service (Cont'd)**

B. Channel Interfaces (Cont'd)

The following channel interface (CI) is available for DDCS (a.k.a. BellSouth SPA Derived Data Channel). (Cont'd)

Compatible channel interface specifications are contained in BellSouth Technical Reference Publication 73548 for data/voice multiplexing equipment and BellSouth Technical Reference 73548, Addendum 1, for the DS0-B interface. These publications are available from the Information Exchange Manager, BellSouth Telecommunications, Inc., Documentations Operations, North W5A1, 3535 Colonnade Parkway, Birmingham, Alabama 35243.

E7.2.16 SMARTRing[®] service (a.k.a. BellSouth Dedicated Ring)

A. Self-healing Multi-nodal Alternate Route Topology Ring

1. SMARTRing[®] service (a.k.a. BellSouth Dedicated Ring) is a dedicated, high capacity, network designed to provide increased reliability and functionality via a self-healing ring topology between multiple customer designated locations and Telephone Company Central Offices where facilities can be made available as determined by the Company. This network consists of fiber routed through local, alternate central office, internodal and/or interoffice channel facilities that transmit DS1, DS3, STS-1, OC-3, OC-12, **OC-48** and/or **1000 Mbps** channel services simultaneously over primary and alternate paths between customer designated locations and Telephone Company Central Offices. This ring topology will continually monitor DS1, DS3, STS-1, OC-3, OC-12, **OC-48** and/or **1000 Mbps** service quality, detect any failure within the system, and automatically self-heal around a point of failure to ensure the flow of DS1, DS3, STS-1, OC-3, OC-12, **OC-48** and/or **1000 Mbps services** between locations within the network.
2. SMARTRing[®] service (a.k.a. BellSouth Dedicated Ring) is available at OC-1, OC-3, OC-3+ OC-12, OC-48, OC-48+, **OC-192** and **OC-192+** capacities.
3. OC-1 SMARTRing[®] service (a.k.a. BellSouth Dedicated Ring) is available only in Overlay Ring Arrangements riding the customer's host OC-12, OC-48, or OC-48+ SMARTRing[®] service (a.k.a. BellSouth Dedicated Ring). The OC-1 SMARTRing[®] service (a.k.a. BellSouth Dedicated Ring) shares the transport of its host SMARTRing[®] service (a.k.a. BellSouth Dedicated Ring). OC-1 SMARTRing[®] service (a.k.a. BellSouth Dedicated Ring) provides an equivalent capacity of 28 DS1s or one STS-1. When an OC-1 SMARTRing[®] service (a.k.a. BellSouth Dedicated Ring) overlays an OC-12, OC-48, or OC-48+ SMARTRing[®] service (a.k.a. BellSouth Dedicated Ring), an OC-1 channel interface is required.
4. OC-3 SMARTRing[®] service (a.k.a. BellSouth Dedicated Ring) is available as an individual service or in an Overlay Ring Arrangement riding the customer's host OC-12, OC-48, OC-48+, **OC-192** or **OC-192+** SMARTRing[®] service (a.k.a. BellSouth Dedicated Ring). OC-3 SMARTRing[®] service (a.k.a. BellSouth Dedicated Ring) provides an equivalent capacity of 3 DS3s, or any combination thereof not to exceed an OC-3 capacity. Channel Interface Reallocation allows the customer to reallocate STS-1, DS3 and/or DS1 capacities to OC-3 nodes subsequent to the initial configuration of an OC03 ring.
5. OC-3+ SMARTRing^{®(1)} service (a.k.a. BellSouth Dedicated Ring) is available as an individual service, or in combination with OC-12 SMARTRing[®] service (a.k.a. BellSouth Dedicated Ring), or in an Overlay Ring Arrangement riding the customer's host OC-48, **OC-192** or **OC-192+** SMARTRing[®] service (a.k.a. BellSouth Dedicated Ring). OC-3+ SMARTRing[®] service (a.k.a. BellSouth Dedicated Ring) provides an equivalent OC-3 capacity, not to exceed 3 DS3s at each node, with a maximum ring capacity of 12 DS3s, not to exceed an OC-12 ring capacity.
6. When a customer orders OC-3+ SMARTRing[®] service (a.k.a. BellSouth Dedicated Ring) in combination with OC-12 SMARTRing[®] service (a.k.a. BellSouth Dedicated Ring), capacity and channel interface availability at each Customer Node and Central Office Node location is determined by the size node ordered by the customer.
7. OC-12 SMARTRing[®] service (a.k.a. BellSouth Dedicated Ring) is available as an individual service, or in combination with OC-3+ SMARTRing[®] service (a.k.a. BellSouth Dedicated Ring), or in an Overlay Ring Arrangement riding the customer's host OC-48, **OC-48+**, **OC-192** or **OC-192+** SMARTRing[®] service (a.k.a. BellSouth Dedicated Ring). OC-12 SMARTRing[®] service (a.k.a. BellSouth Dedicated Ring) provides an equivalent capacity of 12 DS3s.
8. OC-48 SMARTRing[®] service (a.k.a. BellSouth Dedicated Ring) is available as an individual service, **or in an Overlay Ring Arrangement riding the customer's host OC-192 or OC-192+ SMARTRing[®] service (a.k.a. BellSouth Dedicated Ring)**, or with overlaying rings in capacities of OC-1, OC-3, OC-3+ and/or OC-12. OC-48 SMARTRing[®] service (a.k.a. BellSouth Dedicated Ring) provides an equivalent capacity of 48 DS3s.

(1) Effective July 10, 2015, the Company will accept only disconnect order for OC-3+ SMARTRing service (a.k.a. BellSouth SPA Dedicated Ring), including orders associated with existing service. Move, add or change orders will no longer be accepted.

(2) Effective June 30, 2021, this Service will no longer be available for purchase by new or existing customers. In addition, requests to move, add, change, or renew existing service arrangements will not be accepted. Following the expiration of a customer's existing term agreement, service will be provided on a month-to-month basis at the applicable Monthly rates until the service is discontinued. The Company currently plans to discontinue this service on or after June 30, 2024.

(C)

(M)

(M)

(N)

(N)

BELLSOUTH
TELECOMMUNICATIONS
FLORIDA
ISSUED: June 29, 2021
BY: Joe York, President -FL
Jacksonville, Florida

ACCESS SERVICES TARIFF

First Revised Page 27.0.1
Cancels Original Page 27.0.1

EFFECTIVE: June 30, 2021

E7. DEDICATED ACCESS SERVICES**E7.2 Service Description (Cont'd)****E7.2.16 SMARTRing® service (a.k.a. BellSouth Dedicated Ring) (Cont'd)**

9. OC 48+ SMARTRing® service (a.k.a. BellSouth Dedicated Ring) is available as an individual bi directional service, or in an Overlay Ring Arrangement riding the customer's host OC-192 SMARTRing® service (a.k.a. BellSouth Dedicated Ring), or with overlaying rings in capacities of OC 1, and/or OC 3. It provides equivalent capacity of 24 DS3s between consecutive node locations on the ring. The maximum capacity of the OC 48+ SMARTRing® service (a.k.a. BellSouth Dedicated Ring) is determined by the number of Customer and Central Office nodes on the ring.
10. OC-192 SMARTRing® service (a.k.a. BellSouth Dedicated Ring) is available as an individual service, or with overlaying rings in capacities of OC-3, OC-3+, OC-12, OC-48 and /or OC-48+. OC-192 SMARTRing® service (a.k.a. BellSouth Dedicated Ring) provides an equivalent capacity of 192 DS3s.
11. OC-192+ SMARTRing® service (a.k.a. BellSouth Dedicated Ring) is available as an individual bi-directional service, or with overlaying rings in capacities of OC-3, OC-3+, OC-12 and /or OC-48. It provides equivalent capacity of 96 DS3s between consecutive node locations on the ring. The maximum capacity of the OC-192+ SMARTRing® service (a.k.a. BellSouth Dedicated Ring) is determined by the number of Customer and Central Office nodes on the ring.

(M)

(M)

BELLSOUTH
TELECOMMUNICATIONS
FLORIDA

ACCESS SERVICES TARIFF

Fifth Revised Page 27.1
Cancels Fourth Revised Page 27.1

ISSUED: November 30, 2021
BY: Joe York, President -FL
Jacksonville, Florida

EFFECTIVE: December 1, 2021

E7. DEDICATED ACCESS SERVICES**E7.2 Service Description (Cont'd)****E7.2.16 SMARTRing⁷ service (a.k.a. BellSouth Dedicated Ring) (Cont'd)**

(C)

A. Self-healing Multi-nodal Alternate Route Topology Ring (Cont'd)

12. SMARTRing service (a.k.a. BellSouth Dedicated Ring) Channel Interfaces are available as follows:

Channel Interfaces	Nodes							
	OC-1	OC-3	OC-3+	OC-12	OC-48	OC-48+	OC-192	OC-192+
DS1	Yes	Yes	Yes	No ¹	No ¹	No ¹	No ¹	No ¹
DS3	No	Yes	Yes	Yes	Yes	Yes	Yes	Yes
STS-1	Yes	Yes	Yes	Yes	Yes	Yes	Yes	Yes
OC-1 ²	No	No	No	Yes	Yes	Yes	Yes	Yes
OC-3	No	No	No	Yes	Yes	Yes	Yes	Yes
OC-12	No	No	No	No	Yes	Yes	Yes	Yes
28 DS1 Channel System (DS3)	No	Yes	Yes	Yes	Yes	Yes	Yes	Yes
28 DS1 Channel System (STS-1)	No	Yes	Yes	Yes	Yes	Yes	Yes	Yes
1000 Mbps	No	No	No	No	Yes ³	Yes ³	Yes	Yes
100 Mbps BellSouth Metro Ethernet ⁶ Backbone ⁴	No	No	No	Yes	Yes	Yes	Yes	Yes
1000 Mbps BellSouth Metro Ethernet ⁶ Backbone	No	No	No	No	Yes	Yes	Yes	Yes
Fractional 1000 Mbps at 150 Mbps, 300 Mbps or 450 Mbps BellSouth Metro Ethernet ⁶ Backbone ⁵	No	Yes	Yes	Yes	Yes	Yes	Yes	Yes
Fractional 1000 Mbps at 600 Mbps BellSouth Metro Ethernet ⁶ Backbone ⁵	No	No	No	No	Yes	Yes	Yes	Yes

Note 1: DS1 interfaces are available via OC-1, OC-3, and OC-3+ Overlay Ring Arrangements or 28 DS1 Channel Systems only.

Note 2: OC-1 interfaces are only available for use with OC-1 Overlay Ring Arrangements.

Note 3: 1000 Mbps interfaces are only available for rings installed after October 30, 2003. 1000 Mbps transport channel interfaces do not contain any monitoring capability above the physical layer.

Note 4: 100 Mbps BellSouth Metro Ethernet Backbone interfaces are further defined regarding the number of STS-1s utilized in conjunction with the interface.

Note 5: Interfaces are available based on equipment capability.

Note 6: Effective on or after August 22, 2021, this Service will no longer be available for purchase by new or existing customers. In addition, requests to move, add, change, or renew existing service arrangements will not be accepted. Following the expiration of a customer's existing term agreement, service will be provided on a month-to-month basis at the applicable Monthly rates until the service is discontinued. The Company currently plans to discontinue this service on or after March 31, 2023.

Note 7: Effective on or after December 1, 2021, neither new nor existing customers will be permitted to purchase new SMARTRing Service (Service). In addition, (A) Service Payment Plans greater than 12-months in length will no longer be available; and (B) requests to move, add, change, upgrade, or downgrade existing service arrangements will not be accepted, with the following exceptions: (1) existing customers will be permitted to modify their existing Service and will be able to add new circuits to their existing Service, but will not be permitted to add new nodes in any locations; and (2) any such new circuits will be subject to the customer's existing term payment plan or term agreement for the Service to which they are added. Following the expiration of a customer's existing term agreement, Service will be provided on a month-to-month basis at the applicable Month-to-Month rates until the Service is discontinued.

(N)

Effective November 30, 2023, unless specified to the contrary in their existing Service agreements, existing customers may not renew Term Payment Plans or term agreements for Service. In addition, no move, add, or change orders of any type will be accepted.

(N)

BELLSOUTH
TELECOMMUNICATIONS
FLORIDA

ACCESS SERVICES TARIFF

First Revised Page 27.1.0.1
Cancels Original Page 27.1.0.1

ISSUED: November 30, 2021
BY: Joe York, President -FL
Jacksonville, Florida

EFFECTIVE: December 1, 2021

E7. DEDICATED ACCESS SERVICES

E7.2 Service Description (Cont'd)

E7.2.16 SMARTRing¹ service (a.k.a. BellSouth Dedicated Ring) (Cont'd)

(C)

A. Self-healing Multi-nodal Alternate Route Topology Ring (Cont'd)

13. SMARTRing service (a.k.a. BellSouth Dedicated Ring) Overlay Ring Arrangements are available as follows:

Overlaying SMARTRing service (a.k.a. BellSouth Dedicated Ring)	Host SMARTRing service (a.k.a. BellSouth Dedicated Ring)				
	OC-12	OC-48	OC-48+	OC-192	OC-192+
OC-1	X	X	X	X	X
OC-3	X	X	X	X	X
OC-3+		X	X	X	X
OC-12		X	X	X	X
OC-48				X	X
OC-48+					X

14. SMARTRing service (a.k.a. BellSouth Dedicated Ring) is connectible at Telephone Company Central Offices to any 44.736 Mbps and/or 1.544 Mbps services as provided in Section E7. of this Tariff. Rates and charges for such other services are as set forth in the applicable sections of this tariff for such other services.

15. Shared Network Arrangements will not be provided with SMARTRing service (a.k.a. BellSouth Dedicated Ring) at the ring level. Shared Network Arrangements as defined in E2.6 preceding apply to DS1 channel interfaces only.

The customer must provide suitable floor space, controlled environment, and source of non-switched suitable power to support this service.

16. Where the customer provides two separate entrance facility cable routes for SMARTRing service (a.k.a. BellSouth Dedicated Ring), the primary and alternate entrance facilities will be separate and will enter the customer node over such different routes. When the customer requests a connection at a Customer Node via two local channels and Telephone Company facilities do not exist for the second Local Channel, the Telephone Company may provide an equivalent second Local Channel via an existing alternate route. When facilities become available for the second Local Channel, the Telephone Company may rearrange the alternate route at any time.

Note 1: Effective on or after December 1, 2021, neither new nor existing customers will be permitted to purchase new SMARTRing Service (Service). In addition, (A) Service Payment Plans greater than 12-months in length will no longer be available; and (B) requests to move, add, change, upgrade, or downgrade existing service arrangements will not be accepted, with the following exceptions: (1) existing customers will be permitted to modify their existing Service and will be able to add new circuits to their existing Service, but will not be permitted to add new nodes in any locations; and (2) any such new circuits will be subject to the customer's existing term payment plan or term agreement for the Service to which they are added. Following the expiration of a customer's existing term agreement, Service will be provided on a month-to-month basis at the applicable Month-to-Month rates until the Service is discontinued.

(N)

Effective November 30, 2023, unless specified to the contrary in their existing Service agreements, existing customers may not renew Term Payment Plans or term agreements for Service. In addition, no move, add, or change orders of any type will be accepted.

(N)

BELLSOUTH
 TELECOMMUNICATIONS
 FLORIDA
 ISSUED: November 30, 2021
 BY: Joe York, President -FL
 Jacksonville, Florida

ACCESS SERVICES TARIFF

Second Revised Page 27.1.1
 Cancels First Revised Page 27.1.1

EFFECTIVE: December 1, 2021

E7. DEDICATED ACCESS SERVICES

E7.2 Service Description (Cont'd)

E7.2.16 SMARTRing' service (a.k.a. BellSouth Dedicated Ring) (Cont'd)

(C)

A. Self-healing Multi-nodal Alternate Route Topology Ring (Cont'd)

17. When the distance between nodes on a SMARTRing service (a.k.a. BellSouth SPA Dedicated Ring) is such that optical signal regeneration is required, then regeneration equipment will be provided at no additional charge to the customer to assure proper operation of the service. In some cases regeneration will be provided via SONET Add/Drop equipment called a Regeneration Node. A Regeneration Node does not contain the capability to add or drop services. Accordingly, FlexServ service (a.k.a. BellSouth SPA Customer Reconfiguration) Customer Network Management may not be ordered with a Regeneration Node, however, a customer may monitor a Regeneration Node via the FlexServ service (a.k.a. BellSouth SPA Customer Reconfiguration) Customer Network Management Surveillance option when a customer has established surveillance for a ring. Regeneration Node Surveillance is provided as a part of the charges associated with the customer's ring level FlexServ service (a.k.a. BellSouth SPA Customer Reconfiguration) Customer Network Management Surveillance. Regeneration Node and Regeneration Node Surveillance, as applicable, will appear on a customer's records as non-rated USOC(s), as follows:

Regeneration Node, all ring capacities, non-rated	SHNRD
Regeneration Node Surveillance, all ring capacities, non-rated	SHNRS

18. Effective February 16, 2007, Shared Node Interconnection is available, based on equipment capability, whereby two SMARTRing service arrangements belonging to the same customer may share a node in a central office that is common to both rings. Shared Node Interconnection capability is available based on equipment capability. With Shared Node Interconnection, one of the rings (i.e., the larger capacity ring) is considered the Primary Ring and the other ring is considered the Secondary Ring. Primary Rings may be an OC-12, OC-48 or an OC-192 ring. A Secondary Ring is always a lower capacity ring than that of the Primary Ring. The various Shared Node Interconnection service arrangements that are available are as follows:

<u>Shared Node Interconnection Primary Ring Capacity</u>	<u>Shared Node Interconnection Secondary Ring Capacity Available For Use With Primary Rings</u>			
	OC-3	OC-12	OC-48	OC-48+
OC-12	X			
OC-48	X	X		
OC-192	X	X	X	X

With Shared Node Interconnection, the Primary Ring shall have a Central Office Node and the Secondary Ring shall have a Shared Node Interconnection Central Office Node in the central office associated with the ring interconnection. For the Secondary Ring, a Shared Node Interconnection Central Office Node is considered toward meeting the three node minimum requirement for the Secondary Ring. This shared node will utilize capacity of the Primary Ring node, based on the size of the Secondary Ring, and will count toward the capacity the customer has available at the location. Should the customer require more capacity at a shared node central office location than is available on the Primary Ring node, then additional billable service components will be required.

Only one Shared Node Interconnection arrangement is available for an individual Central Office Node on a Primary Ring.

Reconfiguration is not allowed at central office nodes that are configured for Shared Node Interconnection.

Note 1: Effective on or after December 1, 2021, neither new nor existing customers will be permitted to purchase new SMARTRing Service (Service). In addition, (A) Service Payment Plans greater than 12-months in length will no longer be available; and (B) requests to move, add, change, upgrade, or downgrade existing service arrangements will not be accepted, with the following exceptions: (1) existing customers will be permitted to modify their existing Service and will be able to add new circuits to their existing Service, but will not be permitted to add new nodes in any locations; and (2) any such new circuits will be subject to the customer's existing term payment plan or term agreement for the Service to which they are added. Following the expiration of a customer's existing term agreement, Service will be provided on a month-to-month basis at the applicable Month-to-Month rates until the Service is discontinued.

(N)

Effective November 30, 2023, unless specified to the contrary in their existing Service agreements, existing customers may not renew Term Payment Plans or term agreements for Service. In addition, no move, add, or change orders of any type will be accepted.

(N)

BELLSOUTH
TELECOMMUNICATIONS
FLORIDA

ACCESS SERVICES TARIFF

Second Revised Page 27.2
Cancels First Revised Page 27.2

ISSUED: November 30, 2021
BY: Joe York, President -FL
Jacksonville, Florida

EFFECTIVE: December 1, 2021

E7. DEDICATED ACCESS SERVICES

E7.2 Service Description (Cont'd)

E7.2.16 SMARTRing¹ service (a.k.a. BellSouth Dedicated Ring) (Cont'd)

(C)

B. Technical Specifications Packages

1. The compatibility requirements, technical specifications, and generic requirements for SMARTRing service (a.k.a. Bellsouth Dedicated Ring) terminated at the customers designated locations are referenced in Technical Reference ANSI T1.404-1994, ANSI T1.403-1989 and ANSI T1.105-1991.
2. DS3 interface combinations and technical specifications are referenced in Bellcore TR-INS-000342.
3. DS1 interface combinations and technical specifications are referenced in Bellcore TR-NPL-000054.
4. STS-1, OC-1, OC-3, and OC-12 interface combinations and technical specifications are referenced in BellSouth Telecommunications, Inc. Technical Reference TR-73582.
5. These self-healing multi-nodal DS3 high capacity (a.k.a. BellSouth SPA DS3) service channels have a long term performance objective of 99.5 percent error-free seconds and a severely errored second (SES) objective of less than 0.009 percent SES when the circuit is available. Self-healing multi-nodal DS1 high capacity (a.k.a. BellSouth SPA DS1) service channels have a long term performance objective of 99.95 percent error-free seconds.

E7.2.17 Reserved for Future Use

Note 1: Effective on or after December 1, 2021, neither new nor existing customers will be permitted to purchase new SMARTRing Service (Service). In addition, (A) Service Payment Plans greater than 12-months in length will no longer be available; and (B) requests to move, add, change, upgrade, or downgrade existing service arrangements will not be accepted, with the following exceptions: (1) existing customers will be permitted to modify their existing Service and will be able to add new circuits to their existing Service, but will not be permitted to add new nodes in any locations; and (2) any such new circuits will be subject to the customer's existing term payment plan or term agreement for the Service to which they are added. Following the expiration of a customer's existing term agreement, Service will be provided on a month-to-month basis at the applicable Month-to-Month rates until the Service is discontinued.

(N)

Effective November 30, 2023, unless specified to the contrary in their existing Service agreements, existing customers may not renew Term Payment Plans or term agreements for Service. In addition, no move, add, or change orders of any type will be accepted.

(N)

BELLSOUTH
TELECOMMUNICATIONS
FLORIDA

ACCESS SERVICES TARIFF

Fourth Revised Page 27.3
Cancels Third Revised Page 27.3

ISSUED: August 20, 2021
BY: Joe York, President -FL
Jacksonville, Florida

EFFECTIVE: August 22, 2021

E7. SPECIAL ACCESS (A.K.A. BELLSOUTH SPA) SERVICE

E7.2 Service Descriptions (Cont'd)

E7.2.18 BellSouth Metro Ethernet Service²

(C)

- A. BellSouth Metro Ethernet service is a high-speed packet transport that is based on Ethernet transmission parameters. BellSouth Metro Ethernet service provides various transport capabilities that range from 2 Mbps through 1 Gbps with capabilities for basic, premium, and virtual arrangements that may be used to meet individual customer needs.
- B. BellSouth Metro Ethernet service signals meet IEEE 802.3, 802.3u, or 802.3z standards. BellSouth Metro Ethernet service also uses 802.1Q VLAN tagging and stacking for certain service configurations contained herein. Technical requirements for interfaces with customer premises equipment (CPE) are contained in ANSI/IEEE 802.3-2002 Specifications.
- C. BellSouth Metro Ethernet service interface specifications are set forth in BellSouth Technical Reference TR-73632. Technical limitations associated with provisioning 2 Mbps, 4 Mbps and 8 Mbps BellSouth Metro Ethernet Connections based upon distance from the customer's premises to serving wire center and equipment configurations exist and are also set forth in TR-73632.
- D. The rates and charges set forth in E7.5.22 following for BellSouth Metro Ethernet service provide for the furnishing of service in certain metropolitan areas where suitable Company facilities are available. In locations where BellSouth Metro Ethernet service is not available, special construction charges may apply.
- E. A LAN (local area network) is a communications network spanning a limited geographical area. A LAN connects computers and other peripheral equipment for data communications purposes within a building or campus environment.
- F. A VLAN (virtual local area network) is a logical grouping of Metro Ethernet connections that allows data transmission between such connections to occur as if all connections are on the same physical LAN.
- G. Metro Ethernet is a service where Local Area Networks (LANs) send bi-directional Ethernet traffic to other LANs on an Ethernet Wide Area Network (WAN). Ethernet is one of the most widely deployed LAN/WAN standards. BellSouth Metro Ethernet service supports IEEE Standard 802.3, 802.3u and 802.3z transmission standards.
- H. A Metro Ethernet Customer Network is defined as the set of interconnected Metro Ethernet connections assigned to the same VLAN within the BellSouth core network. Premium Connections that include the Q-Forwarding optional feature described in O. following and Virtual Connections that include the VLAN Aggregation optional feature described in P. following may be part of more than one Metro Ethernet Customer Network.
- I. A Basic BellSouth Metro Ethernet service Connection provides 2 Mbps, 4 Mbps, 8 Mbps, 10 Mbps, 100 Mbps and 1 Gbps Ethernet capabilities that are a part of a BellSouth Metro Ethernet service network within a metropolitan area. Basic BellSouth Metro Ethernet service is a best effort service with service capabilities that are affected by overall traffic on the Basic BellSouth Metro Ethernet service network and is suitable for data transmission only.

A Basic BellSouth Metro Ethernet service connection operating at any of these speeds is capable of interconnecting with other Basic BellSouth Metro Ethernet service Connections that are operating at any of these speeds in the same metropolitan area.

A Basic BellSouth Metro Ethernet service connection provides data channel transport that connects customer premises¹ that are 10 miles or less in distance from the BellSouth Metro Ethernet service wire center associated with the Basic BellSouth Metro Ethernet service Connection. Customer locations¹ greater than 10 miles from the Basic BellSouth Metro Ethernet service wire center also require BellSouth Metro Ethernet service Additional Mileage charges.

Note 1: And as alternatively set forth in E7.4.32.A.5. *and 6.* Following

Note 2: Effective on or after August 22, 2021, this Service will no longer be available for purchase by new or existing customers. In addition, requests to move, add, change, or renew existing service arrangements will not be accepted. Following the expiration of a customer's existing term agreement, service will be provided on a month-to-month basis at the applicable Monthly rates until the service is discontinued. The Company currently plans to discontinue this service on or after March 31, 2023.

(N)

(N)

BELLSOUTH
TELECOMMUNICATIONS
FLORIDA

ACCESS SERVICES TARIFF

Fourth Revised Page 27.3.1
Cancels Third Revised Page 27.3.1

ISSUED: August 20, 2021
BY: Joe York, President -FL
Jacksonville, Florida

EFFECTIVE: August 22, 2021

E7. SPECIAL ACCESS (A.K.A. BELLSOUTH SPA) SERVICE

E7.2 Service Descriptions (Cont'd)

E7.2.18 BellSouth Metro Ethernet Service (Cont'd)³

(C)

- J.** A Premium BellSouth Metro Ethernet service Connection provides 2 Mbps, 4 Mbps, 8 Mbps, 10 Mbps, 20 Mbps, 50 Mbps, 100 Mbps, 250 Mbps, 500 Mbps and 900 Mbps Ethernet capabilities that are a part of a BellSouth Metro Ethernet service network within a metropolitan area. Premium BellSouth Metro Ethernet service provides the ability to order Ethernet Service with improved service characteristics to meet customer needs regarding the assurance of bandwidth availability.

Premium BellSouth Metro Ethernet service provides customer capabilities to assure service characteristics via ordering a Committed Bandwidth (CBW). A CBW is the minimum bandwidth across the BellSouth Metro Ethernet service network within a metropolitan area between a customer's Premium BellSouth Metro Ethernet service locations.

Premium BellSouth Metro Ethernet service Connections are available with "Fixed" and "Burst" capabilities unless specified otherwise¹. With the Fixed arrangement, Premium BellSouth Metro Ethernet service Connections will have the bandwidth ordered (e.g., 10 Mbps) available across the BellSouth Metro Ethernet service network. With the Burst arrangement, Premium BellSouth Metro Ethernet service Connections will have the ability to send burst of data above their CBW rate, if network capacity *and facilities are* available. For example, a 10 Mbps, a 20 Mbps and a 50 Mbps Connection may Burst up to 100 Mbps, while a 100 Mbps, a 250 Mbps and a 500 Mbps Connection may Burst up to 1 Gbps.

A Premium BellSouth Metro Ethernet service Connection operating at any of these speeds is capable of interconnecting with other Premium BellSouth Metro Ethernet service Connections that are operating at any of these speeds in the same metropolitan area.

A Premium BellSouth Metro Ethernet service Connection provides data channel transport that connects customer premises² that are 10 miles or less in distance from the BellSouth Metro Ethernet service wire center associated with the Premium BellSouth Metro Ethernet service Connection. Customer locations² greater than 10 miles from the Premium BellSouth Metro Ethernet service wire center also require BellSouth Metro Ethernet service Additional Mileage charges.

Note 1: Premium Connections at 2 Mbps, 4 Mbps, 8 Mbps and 900 Mbps are available only as Fixed arrangements (i.e., "Burst" capability is not available).

Note 2: And is alternatively set forth in E7.4.32.A.5. and 6. following.

Note 3: Effective on or after August 22, 2021, this Service will no longer be available for purchase by new or existing customers. In addition, requests to move, add, change, or renew existing service arrangements will not be accepted. Following the expiration of a customer's existing term agreement, service will be provided on a month-to-month basis at the applicable Monthly rates until the service is discontinued. The Company currently plans to discontinue this service on or after March 31, 2023.

(N)

(N)

BELLSOUTH
TELECOMMUNICATIONS
FLORIDA

ACCESS SERVICES TARIFF

Fifth Revised Page 27.4
Cancels Fourth Revised Page 27.4

ISSUED: August 20, 2021
BY: Joe York, President -FL
Jacksonville, Florida

EFFECTIVE: August 22, 2021

E7. SPECIAL ACCESS (A.K.A. BELLSOUTH SPA) SERVICE

E7.2 Service Descriptions (Cont'd)

E7.2.18 BellSouth Metro Ethernet Service (Cont'd)²

(C)

K.

- L. A Virtual BellSouth Metro Ethernet Service Connection provides 2 Mbps, 4 Mbps, 8 Mbps, 10 Mbps, 20 Mbps, 50 Mbps, 80 Mbps, 100 Mbps, 200 Mbps, 300 Mbps, 450 Mbps, 600 Mbps, 750 Mbps and 900 Mbps Ethernet capabilities that are a part of a BellSouth Metro Ethernet Service network within a metropolitan area. Virtual BellSouth Metro Ethernet Service provides the ability to order Ethernet Service where a single customer connection can support multiple applications with varying Quality of Service (QoS) features and Classes of Service.

Virtual BellSouth Metro Ethernet Service provides customer capabilities to support different Classes of Service (CoS) (i.e., Real-Time, Interactive, Business Critical and Best Effort as described in E7.2.18.T) over the same Connection and offers customers increased flexibility to match bandwidth to their real needs for voice/data/video applications on each Connection. The customer orders the percentage of their Virtual BellSouth Metro Ethernet Service Connection bandwidth that will be allocated for each class of service.

For each Virtual Connection, the customer's bandwidth will be limited to the fixed speed associated with each CoS level specified in the CoS profile selected for the Virtual Connection.

A Virtual BellSouth Metro Ethernet Service Connection operating at any of these speeds is capable of interconnecting with other Virtual BellSouth Metro Ethernet Service Connections that are operating at any of these speeds in the same metropolitan area.

A Virtual BellSouth Metro Ethernet Service Connection provides data channel transport that connects customer premises¹ that are 10 miles or less in distance from the BellSouth Metro Ethernet Service wire center associated with the Virtual BellSouth Metro Ethernet Service Connection. Customer locations¹ greater than 10 miles from the Virtual BellSouth Metro Ethernet Service wire center also require BellSouth Metro Ethernet Service Additional Mileage charges.

Note 1: And as alternatively set forth in E7.4.32.A.5. *and* 6. following.

Note 2: Effective on or after August 22, 2021, this Service will no longer be available for purchase by new or existing customers. In addition, requests to move, add, change, or renew existing service arrangements will not be accepted. Following the expiration of a customer's existing term agreement, service will be provided on a month-to-month basis at the applicable Monthly rates until the service is discontinued. The Company currently plans to discontinue this service on or after March 31, 2023.

(N)

(N)

BELLSOUTH
TELECOMMUNICATIONS
FLORIDA

ACCESS SERVICES TARIFF

Fourth Revised Page 27.4.1
Cancels Third Revised Page 27.4.1

ISSUED: August 20, 2021
BY: Joe York, President -FL
Jacksonville, Florida

EFFECTIVE: August 22, 2021

E7. SPECIAL ACCESS (A.K.A. BELLSOUTH SPA) SERVICE

E7.2 Service Descriptions (Cont'd)

E7.2.18 BellSouth Metro Ethernet Service (Cont'd)²

(C)

- M.** BellSouth Metro Ethernet service Additional Mileage charges associated with a BellSouth Metro Ethernet service Connection apply when the total distance from the customer premises¹ to the BellSouth Metro Ethernet service wire center associated with the service serving the customer premises¹ is greater than 10 miles in length. The additional mileage is measured in airline miles from the customer premises¹ to the BellSouth Metro Ethernet service wire center associated with the BellSouth Metro Ethernet service. Fractions of miles will be considered as a whole mile.

BellSouth Metro Ethernet service Additional Mileage charges apply to Basic, Premium and Virtual BellSouth Metro Ethernet service based on the service's speed and the total distance associated with the data channel. The BellSouth Metro Ethernet service Additional Mileage Charge is based on the mileage band the total data channel mileage falls into. For example, a data channel that is 30 miles in length would be charged the additional mileage rate for the greater than 25 mile through 35 mile band.

- N.** Priority Plus is an optional feature available to customers with Premium BellSouth Metro Ethernet service. Priority Plus provides the customer with the ability to prioritize their traffic in accordance with a predefined hardware queue model approach. With this option, customers will assign priority values to their data and higher-priority data will be transmitted first. Priority Plus service traffic is limited to a small subset of the total Committed Bandwidth (CBW) traffic and is marked for expedited handling within the Metro Ethernet Service. Customers that desire Priority Plus must establish it for all of their Premium BellSouth Metro Ethernet service Connections within that Metro Ethernet Customer Network.

- O.** Q-Forwarding is an optional feature available to customers with Premium BellSouth Metro Ethernet service. Q-Forwarding provides VLAN aggregation across a common physical connection. This feature supports customer aggregation of traffic from multiple Metro Ethernet Customer Networks (referred to as VLANS). This aggregated traffic can be transported back to a central location and across a common Metro Ethernet Service Connection (referred to as the "aggregation" connection). Q-Forwarding utilizes IEEE 802.1Q VLAN Tagging procedures.

While Q-Forwarding is available with BellSouth Premium Metro Ethernet Connections at 2 Mbps, 4 Mbps and 8 Mbps, this feature is subject to technical limitations set forth in Technical Reference 73632 when used with these speed connections.

With Q-Forwarding, special technical considerations set forth in Technical Reference 73632 must be taken into account to determine the customer's CBW across their BellSouth Metro Ethernet Network.

The Q-Forwarding Service Establishment Charge is a charge to provision a Premium Metro Ethernet Connection with the Q-Forwarding feature and identify it as an "aggregation" connection.

The Q-Forwarding Network Assignment Charge is a charge to provision each Metro Ethernet Customer Network to the Q-Forwarding "aggregation" connection. The Q-Forwarding Network Assignment Charge applies for each VLAN connected to the Q-Forwarding "aggregation" connection.

- P.** VLAN Aggregation is an optional feature available to customers with Virtual BellSouth Metro Ethernet Service. VLAN Aggregation provides VLAN aggregation across a common physical connection. This feature supports customer aggregation of traffic from multiple Metro Ethernet Customer Networks (referred to as VLANS) comprised of Virtual Connections. This aggregated traffic can be transported back to a central location and across a common Virtual Metro Ethernet Service Connection (referred to as the "aggregation" connection). VLAN Aggregation utilizes IEEE 802.1Q VLAN Tagging procedures.

While VLAN Aggregation is available with BellSouth Virtual Metro Ethernet Connections at 2 Mbps, 4 Mbps and 8 Mbps, this feature is subject to technical limitations set forth in Technical Reference 73632 when used with these speed connections.

The VLAN Aggregation Service Establishment Charge is a charge to provision a Virtual Metro Ethernet Connection with this feature and identify it as an "aggregation" connection.

The VLAN Aggregation Network Assignment Charge is a charge to provision each Virtual Ethernet Customer Network to the "aggregation" connection. The VLAN Aggregation Network Assignment Charge applies for each VLAN connected to the "aggregation" connection.

Note 1: And as alternatively set forth in E7.4.32.A.5. following.

Note 2: Effective on or after August 22, 2021, this Service will no longer be available for purchase by new or existing customers. In addition, requests to move, add, change, or renew existing service arrangements will not be accepted. Following the expiration of a customer's existing term agreement, service will be provided on a month-to-month basis at the applicable Monthly rates until the service is discontinued. The Company currently plans to discontinue this service on or after March 31, 2023.

(N)
|
(N)

BELLSOUTH
TELECOMMUNICATIONS
FLORIDA

ACCESS SERVICES TARIFF

Fourth Revised Page 27.5
Cancels Third Revised Page 27.5

ISSUED: August 20, 2021
BY: Joe York, President -FL
Jacksonville, Florida

EFFECTIVE: August 22, 2021

E7. SPECIAL ACCESS (A.K.A. BELLSOUTH SPA) SERVICE

E7.2 Service Descriptions (Cont'd)

E7.2.18 BellSouth Metro Ethernet Service (Cont'd)¹

(C)

- Q. Customer Network Management (CNM)** - Metro Ethernet Reporting is an optional feature available to customers with Premium or Virtual BellSouth Metro Ethernet service. **CNM** - Metro Ethernet Reporting provides customers a view into their BellSouth Metro Ethernet service network via the use of a web interface and security card. **CNM** - Metro Ethernet Reporting provides alarm surveillance, service level agreement reporting and performance reporting for the various network components that comprise the customer's BellSouth Metro Ethernet service network. This feature is only available to customers purchasing Premium or Virtual BellSouth Metro Ethernet service.

Customers who subscribe to **CNM** - Metro Ethernet Reporting must monitor their entire BellSouth Metro Ethernet Network. The **CNM** - Metro Ethernet Reporting Charge is applicable for each Premium or Virtual Metro Ethernet Service Connection.

The **CNM** - Metro Ethernet Reporting Service Establishment Charge is a nonrecurring charge that applies to initially establish a new Metro Ethernet Service customer account. A customer with an existing **CNM** - Metro Ethernet Reporting customer account from another BellSouth jurisdiction may re-use that customer account.

All customers purchasing **CNM** - Metro Ethernet Reporting must have a web interface that will allow the customer to access and monitor their network via the web. Each web interface provides for one concurrent access. Additional concurrent accesses will require additional web interfaces. An initial web interface (Web Interface Charge - First) is provided with the initial establishment of a customer account. A monthly charge and a nonrecurring charge are applicable for each additional web interface requested for a customer account (Web Interface Charge – Each Additional).

A security card is required to access a web interface. Each security card can only be used for a single concurrent access and can be associated with only one web interface. A Security Card Charge will apply for the initial and additional cards requested and for the issuance of additional cards to replace lost, damaged or expired cards. A nonrecurring charge is applicable per security card requested.

- R.** BellSouth Metro Ethernet service Customer networks comprised of Premium Connections or Virtual Connections with **CNM** - Metro Ethernet Reporting are provided Service Level Agreements (SLAs) for the Company's repair and performance commitments for this service. Credits are provided for missed commitments on such service. The specific SLA commitments and credits applicable are set forth in E7.4.32.C. following for Premium Connections and in Section E7.4.32.D. for Virtual Connections.
- S.** Subsequent to its initial installation, a customer may request to reconfigure or change a BellSouth Metro Ethernet service Connection. The Service Reconfiguration Charge or System Reconfiguration Charge will be the nonrecurring charge applicable for such a request; the appropriate nonrecurring charge will be based upon the reconfiguration or change requested, as specifically described and set forth in E7.4.32 following.
- T.** For each Virtual BellSouth Metro Ethernet Connection the customer must decide the mix of applications that will be supported on that Connection, the CoS mix that Virtual Connection must support, and the percentage of bandwidth to be assigned for each CoS (i.e., build a CoS profile for each Virtual Connection). The customer's bandwidth will be limited to the fixed speed associated with each CoS level. Therefore, total bandwidth available to support transmission of a specific CoS will depend upon the size of the customer's Connection and the specific CoS percentage the customer selected for that Connection.

A customer may request a single CoS or up to four CoS to build the CoS Profile for a Virtual Connection. The customer determines the percentage bandwidth each CoS selected should be of the total Virtual Connection's bandwidth. The sum of the percentages for each CoS selected for a Virtual Connection must equal 100%. Additionally, the combined CoS bandwidth percentages selected in a customer's CoS Profile for Real-Time CoS plus Interactive CoS may not exceed 50%, except where the customer selects the 70% Real-Time CoS bandwidth percentage and has no Interactive traffic.

A customer may select different CoS profiles for different Virtual Connections that share the same network VLAN, or Virtual Connection network arrangement. However, technical limitations exist as discussed in TR-73632 that limit the total number of different CoS profiles that can be utilized in a single Virtual Connection network arrangement.

Note 1: Effective on or after August 22, 2021, this Service will no longer be available for purchase by new or existing customers. In addition, requests to move, add, change, or renew existing service arrangements will not be accepted. Following the expiration of a customer's existing term agreement, service will be provided on a month-to-month basis at the applicable Monthly rates until the service is discontinued. The Company currently plans to discontinue this service on or after March 31, 2023.

(N)

(N)

BELLSOUTH
TELECOMMUNICATIONS
FLORIDA

ACCESS SERVICES TARIFF

First Revised Page 27.5.1
Cancels Original Page 27.5.1

ISSUED: August 20, 2021
BY: Joe York, President -FL
Jacksonville, Florida

EFFECTIVE: August 22, 2021

E7. SPECIAL ACCESS (A.K.A. BELLSOUTH SPA) SERVICE

E7.2 Service Descriptions (Cont'd)

E7.2.18 BellSouth Metro Ethernet Service (Cont'd)²

(C)

T. (Cont'd)

The CoS and percentage bandwidth selected for a Virtual Connection will define the applications that can be supported and its Quality of Service (QoS) attributes such as traffic priority, latency, packet loss rate, etc. QoS attributes are defined for each CoS. Each Virtual Connection will support Ethernet traffic representing one or more applications and CoS. Virtual Connections support the four following CoS:

- Real-Time¹: This CoS supports VoIP applications. The Real-Time CoS is supported by a low latency queue. The Low Latency Queuing (LLQ) feature in the Ethernet network is used for support of the Real-Time CoS.
- Interactive¹: This CoS supports interactive Video applications. The Interactive CoS is policed to a maximum bandwidth.
- Business Critical: This CoS supports mission-critical business data applications. These applications tend to be data specific and may include medical imaging, electronic funds transfer, medical records transfer, etc.
- Best Effort: This CoS is the default CoS for all other traffic that is not defined as Business Critical, Real-Time or Interactive. Traffic that does not match the other CoS will be mapped as Best Effort. Traffic with the Best Effort CoS will have the lowest priority on the network and will support lower priority data applications, such as email and file transfer protocol (FTP).

Each customer packet from a Virtual Connection will be classified and assigned to a specific CoS by methods identified in TR-73632.

Note 1: The combined CoS bandwidth percentages selected in a customer's Virtual Connection CoS profile for Real-Time CoS plus Interactive CoS may not exceed 50%, except where the customer selects the 70% Real-Time CoS bandwidth percentage and has no Interactive traffic.

Note 2: Effective on or after August 22, 2021, this Service will no longer be available for purchase by new or existing customers. In addition, requests to move, add, change, or renew existing service arrangements will not be accepted. Following the expiration of a customer's existing term agreement, service will be provided on a month-to-month basis at the applicable Monthly rates until the service is discontinued. The Company currently plans to discontinue this service on or after March 31, 2023.

(N)

(N)

BELLSOUTH
TELECOMMUNICATIONS
FLORIDA

ACCESS SERVICES TARIFF

Third Revised Page 27.5.2
Cancels Second Revised Page 27.5.2

ISSUED: August 20, 2021
BY: Joe York, President -FL
Jacksonville, Florida

EFFECTIVE: August 22, 2021

E7. SPECIAL ACCESS (A.K.A. BELLSOUTH SPA) SERVICE

E7.2 Service Descriptions (Cont'd)

E7.2.18 BellSouth Metro Ethernet Service (Cont'd)²

(C)

- U. Automatic Protection Switching (APS) is an optional feature available, except as specified otherwise herein, to customers with a Basic, Premium or Virtual BellSouth Metro Ethernet Service Connection of 10 Mbps or higher¹. The APS feature provides customers with the option of having data channel (i.e., facilities from the customer premises to the BellSouth Metro Ethernet Service wire center) survivability through the use of a secondary transport path that is diverse from the path provided with their primary Metro Ethernet Connection. This secondary transport path (i.e., data channel) is provided for a specific Metro Ethernet Connection (i.e., the primary) with the selection of the APS feature which then provides the customer with complete path protection. However, APS is not available for a 2 Mbps, 4 Mbps or 8 Mbps Connection.

With APS, the primary Metro Ethernet Connection's data channel is monitored for threshold violations or path failures with a fail-over to the secondary data channel path provided via the APS feature. The APS data channel is checked periodically to ensure its availability if a failure of the primary Metro Ethernet Connection's data channel occurs.

APS may be ordered as a structurally diverse transport path (Structural Protection) or a route diverse transport path (Route Protection).

Structural Protection APS is defined as the APS facility and the primary Metro Ethernet Connection facility being in separate sheaths in separate structures located along the same route (e.g., underground/underground, buried/underground, aerial/underground, aerial/buried, buried/buried, and aerial/aerial), or along different routes at the Telephone Company's discretion

Route Protection APS is defined as the APS facility being in a separate sheath within alternate underground, aerial or direct buried structures that are run along separate physical paths from the facilities associated with the primary Metro Ethernet Connection. No precise distance separation is specified between the paths; although the separation is sufficient to preclude one disruptive event from affecting both routes.

The APS feature is billed based upon the actual total route miles in a customer's specific Structural Protection APS or Route Protection APS design as determined by the Telephone Company. The term "route miles" is defined for this application to be the actual physical distance or length (not airline mileage), rounded up to the next whole mile, of the unique APS facility designed for each individual customer premises. Total route miles are measured between the customer premises and its serving wire center, plus route miles between the serving wire center and any intermittent wire centers in the path designed to reach the BellSouth Metro Ethernet wire center associated with the primary Metro Ethernet Connection (i.e., the wire center where the BellSouth Metro Ethernet switching equipment is located).

The APS rate element provides the alternate data channel transport and APS equipment in the BellSouth Metro Ethernet Service wire center associated with the primary Metro Ethernet Connection. Actual total route mileage for the customer's APS design is determined from a Service Inquiry. The route mileage determined from this Telephone Company Service Inquiry is used for billing purposes and is the sole determinant of such mileage (i.e., not subject to dispute).

- V. BellSouth Metro Ethernet Service Independent Company (ICO) Trunk Connection

Provides interconnection between BellSouth's Ethernet network and the Ethernet network of an Independent Telephone Company. A BellSouth Metro Ethernet Service ICO Trunk Connection provides data channel transport for connections that are 10 airline miles or less in distance from the BellSouth Metro Ethernet Service ICO Trunk Connection wire center to the meet-point with the Independent Company. Meet-point locations greater than 10 airline miles from the BellSouth Metro Ethernet Service ICO Trunk Connection wire center also require BellSouth Metro Ethernet Service ICO Trunk Additional Mileage charges.

- W. BellSouth Metro Ethernet Service Independent Company (ICO) Trunk Additional Mileage Charges

Additional mileage charges associated with a BellSouth Metro Ethernet Service ICO Trunk Connection apply when the total distance from the BellSouth Metro Ethernet Service ICO Trunk Connection wire center to the meet-point with the Independent Company is greater than 10 miles in length. The additional mileage is measured in airline miles from the BellSouth Metro Ethernet Service wire center associated with the BellSouth Metro Ethernet Service ICO Trunk Connection to the Independent Company meet-point. Fractions of miles will be considered as a whole mile.

Note 1: Automatic Protection Switching (APS) is not available for a 2 Mbps, 4 Mbps or 8 Mbps Basic, Premium or Virtual Connection.

Note 2: Effective on or after August 22, 2021, this Service will no longer be available for purchase by new or existing customers. In addition, requests to move, add, change, or renew existing service arrangements will not be accepted. Following the expiration of a customer's existing term agreement, service will be provided on a month-to-month basis at the applicable Monthly rates until the service is discontinued. The Company currently plans to discontinue this service on or after March 31, 2023.

(N)

(N)

BELLSOUTH
TELECOMMUNICATIONS
FLORIDA

ACCESS SERVICES TARIFF

Third Revised Page 27.5.3
Cancels Second Revised Page 27.5.3

ISSUED: August 20, 2021
BY: Joe York, President -FL
Jacksonville, Florida

EFFECTIVE: August 22, 2021

E7. SPECIAL ACCESS (A.K.A. BELLSOUTH SPA) SERVICE

E7.2 Service Descriptions (Cont'd)

E7.2.18 BellSouth Metro Ethernet Service (Cont'd)¹

(C)

X. Migration to AT&T Switched Ethernet ServiceSM

Customers subscribing to BellSouth Metro Ethernet Service may migrate to AT&T Switched Ethernet Service provided by the Company without incurring termination charges, subject to the following conditions:

- The new AT&T Switched Ethernet Service and the existing BellSouth Metro Ethernet Service must be billed to the same customer of record at the same customer locations.
- The customer's existing service must have been in place for at least 12 months.
- The minimum term for the new service must be at least 12 months and must be equal to or greater than the number of months remaining in the customer's existing Transport Payment Plan (TPP) term.
- The speed (capacity/bandwidth) of the new service must be equal to or greater than that of the existing service.
- The customer must issue a disconnect order for the replaced BellSouth Metro Ethernet Service to be effective within 90 days after the AT&T Switched Ethernet Service installation date. The disconnect and new orders must be coordinated through the Company.
- If overlapping service is required, the period will be limited to not more than 90 days and billing will apply to both services during the time both services are available.

Note 1: Effective on or after August 22, 2021, this Service will no longer be available for purchase by new or existing customers. In addition, requests to move, add, change, or renew existing service arrangements will not be accepted. Following the expiration of a customer's existing term agreement, service will be provided on a month-to-month basis at the applicable Monthly rates until the service is discontinued. The Company currently plans to discontinue this service on or after March 31, 2023.

(N)

(N)

BELLSOUTH
TELECOMMUNICATIONS
FLORIDA
ISSUED: June 29, 2021
BY: Joe York, President -FL
Jacksonville, Florida

ACCESS SERVICES TARIFF

First Revised Page 27.6
Cancels Original Page 27.6

EFFECTIVE: June 30, 2021

E7. DEDICATED ACCESS SERVICES**E7.3 Channel Interface and Network Channel Codes**

This section explains the Channel Interface codes and Network Channel codes that the customer must specify when ordering Dedicated Access Service. Included is an example which explains the specific characters of the code, a glossary of Channel Interface codes, impedance levels, and Network Channel codes. Compatible Channel Interface codes are contained in the services respective Technical Reference Publications as indicated in E7.2.

Example: If the customer specifies a LB Network Channel Code and a 2LC8 Channel Interface at the customer's premises, the following is being requested:

LB = Voice Grade¹ (a.k.a. BellSouth SPA DS0 VG) Channel with a Predefined Technical Specification Package (1) (C)
 2 = Number of physical wires at customer premises
 LC = Facility interface for Type C Signaling
 8 = Variable impedance level

E7.3.1 Glossary of Channel Interface Codes and Options

Code - Option	Definition	
AB -	Accepts 20 Hz ringing signal at customer's point of termination	
AC -	Accepts 20 Hz ringing signal at the customer's point of termination	
CS -	Digital hierarchy interface at Digital Crossconnect System (DCS)	
- EA	E & M Signaling	
- GO	Ground Start Loop Signaling-Open End	
- GS	Ground Start Loop Signaling-Closed End	
- LO	Loop Start Loop Signaling-Open End	
- LS	Loop Start Loop Signaling-Closed End	
- NO	Transmission Only - No Signaling	
- R	(DS0) Customer Reconfigurable Voice Grade Service ¹	(C)
- 10R	DS1 to DS0 Customer Reconfigurable ¹	(C)
	(DELETED)	(D)
- 10	DS1 to DS0 ¹	(C)

Note 1: Effective June 30, 2021, this Service will no longer be available for purchase by new or existing customers. In addition, requests to move, add, change, or renew existing service arrangements will not be accepted. Following the expiration of a customer's existing term agreement, service will be provided on a month-to-month basis at the applicable Monthly rates until the service is discontinued. The Company currently plans to discontinue this service on or after June 30, 2024. (N)

BELLSOUTH
 TELECOMMUNICATIONS
 FLORIDA
 ISSUED: June 29, 2021
 BY: Joe York, President -FL
 Jacksonville, Florida

ACCESS SERVICES TARIFF

First Revised Page 28
 Cancels Original Page 28

EFFECTIVE: June 30, 2021

E7. DEDICATED ACCESS SERVICES¹

E7.3 Channel Interface and Network Channel Codes (Cont'd)

E7.3.1 Glossary of Channel Interface Codes and Options (Cont'd)

Code - Option	Definition
- 11R	DS1 to DS1 Customer Reconfigurable
- 11	DS1 to DS1
- SP	Resistive Type: Split Path Operation for Data Polling Conference Type
- CF	Resistive Type: Split Path Operation for Symmetrical Voice Conference Type
- BC	CO Bridging: Broadcast for Broadcast Conference Type
CT -	Centrex Tie Trunk Termination
DA -	Data stream in VF frequency band at customer's point of termination
DB -	Data stream in VF frequency band at customer's point of termination
- 10	VF for TG1 and TG2
- 43	VF for 43 Telegraph ² Carrier type signals, TG1 and TG2
DD -	Dataphone [®] Select-A-Station (and TABS) interface at customer's point of termination
DE -	Dataphone [®] Select-A-Station (and TABS) interface at the customer's end user's point of termination
DS -	Digital hierarchy interface
- 1K	1.544 Mbps (DS1) ANSI Extended Superframe (ESF) format
- 1S	1.544 Mbps (DS1) ANSI Extended Superframe (ESF) format and B8ZS Clear Channel Capability
- 15	1.544 Mbps (DS1) Superframe (SF) format
- 15B	1.544 Mbps (DS1) Superframe (SF) format and B8ZS Clear Channel Capability
- 15E	8-bit PCM encoded in one 64 Kbps of the DS1 signal
- 15F	8-bit PCM encoded in two 64 Kbps of the DS1 signal
- 15G	8-bit PCM encoded in three 64 Kbps of the DS1 signal
- 15H	14/11-bit PCM encoded in six 64 Kbps of the DS1 signal
- 15J	1.544 Mbps format per PUB 41451 (only available to U.S. Govt. agencies)
- 31	3.152 Mbps (DS1C)
- 31L	3.152 Mbps (DS1C) with SF signaling
- 44	44.736 Mbps (DS3)

Note 1: Text is shown as new due to reissue of all Tariff Sections. No changes in rates or regulations were made with this Filing.

Note 2: Effective June 30, 2021, this Service will no longer be available for purchase by new or existing customers. In addition, requests to move, add, change, or renew existing service arrangements will not be accepted. Following the expiration of a customer's existing term agreement, service will be provided on a month-to-month basis at the applicable Monthly rates until the service is discontinued. The Company currently plans to discontinue this service on or after June 30, 2024.

(C)

(N)

(N)

BELLSOUTH
 TELECOMMUNICATIONS
 FLORIDA
 ISSUED: June 29, 2021
 BY: Joe York, President -FL
 Jacksonville, Florida

ACCESS SERVICES TARIFF

First Revised Page 29
 Cancels Original Page 29

EFFECTIVE: June 30, 2021

E7. DEDICATED ACCESS SERVICES¹

E7.3 Channel Interface and Network Channel Codes (Cont'd)

E7.3.1 Glossary of Channel Interface Codes and Options (Cont'd)

Code - Option	Definition
- 44L	44.736 Mbps (DS3) with SF signaling
- 63	6.312 Mbps (DS2)
- 63L	6.312 Mbps (DS2) with SF signaling
DU -	Digital access interface
- 19(S) ²	19.2 Kbps ³
- 24(S) ²	2.4 Kbps ³
- 48(S) ²	4.8 Kbps ³
- 56(S) ²	56.0 Kbps ³
- 64	64.0 Kbps ³
- 96(S) ²	9.6 Kbps ³
- 1KN	DS1 (1.544 Mbps) ANSI Extended Superframe (ESF) Format per TR-NPL-000054 without line power
- 1SN	DS1 (1.544 Mbps) ANSI Extended Superframe (ESF) Format per TR-NPL-000054, with B8ZS Clear Channel Capability and without line power
- A	DS1 (1.544 Mbps) free-framing format per PUB 41451 with line power (only available to U. S. Govt. agencies)
- AN	DS1 (1.544 Mbps) free-framing format per PUB 41451 without line power (only available to U. S. Govt. agencies)
- BN	DS1 (1.544 Mbps) Superframe (SF) Format per TR-NPL-000054 without line power
- DN	DS1 (1.544 Mbps) Superframe (SF) Format per TR-NPL-000054, with B8ZS Clear Channel Capability and without line power.
- SN	1.544 Mbps (DS1) ANSI Extended Superframe (ESF) format and B8ZS Clear Channel Capability
DV -	Data and Voice Multiplexing
- BC	Digital Data Over Voice, 9.6 Kbps ³
DX -	Duplex signaling interface at customer's point of termination
EA - E	Type I, E&M Lead Signaling. Customer at POT or end user at POT originates one E Lead.
EA - M	Type I E&M Lead Signaling. Customer at POT or end user at POT originated on M Lead.

(C)
 |
 (C)

(C)

Note 1: Text is shown as new due to reissue of all Tariff Sections. No changes in rates or regulations were made with this Filing.

Note 2: (S) is an additional BellSouth designation for use when the optional Secondary Channel feature is required.

Note 3: Effective June 30, 2021, this Service will no longer be available for purchase by new or existing customers. In addition, requests to move, add, change, or renew existing service arrangements will not be accepted. Following the expiration of a customer's existing term agreement, service will be provided on a month-to-month basis at the applicable Monthly rates until the service is discontinued. The Company currently plans to discontinue this service on or after June 30, 2024.

(N)
 |
 (N)

BELLSOUTH
TELECOMMUNICATIONS, INC.

ACCESS SERVICE TARIFF

Original Page 30

FLORIDA

ISSUED: July 1, 1996

EFFECTIVE: July 15, 1996

BY: Joseph P. Lacher, President - FL
Miami, Florida

E7. DEDICATED ACCESS SERVICES¹

(N)

E7.3 Channel Interface and Network Channel Codes (Cont'd)**E7.3.1 Glossary of Channel Interface Codes and Options (Cont'd)**

Code - Option	Definition
EB - E	Type II, E&M Lead Signaling. Customer at POT or end user at POT originates on E Lead.
EB - M	Type II E&M Lead Signaling. Customer at POT or customer's end user at POT originates on M Lead.
EC -	Type III, E&M signaling at customer POT.
EX - A	Tandem channel unit signaling for loop start or ground start and customer supplies open end (dial tone, etc.) functions.
- B	Tandem channel unit signaling for loop start or ground start and customer supplies closed end (dial pulsing, etc.) functions.
GO -	Ground start loop signaling - open end function by customer or customer's end user
GS -	Ground start loop signaling - closed end function by customer or customer's end user
- C	Centrex foreign exchange termination
- M	For terminating in central office located answering service concentrator
LA -	End user loop start loop signaling - Type A OPS registered port open end
LB -	End user loop start loop signaling - Type B OPS registered port open end
LC -	End user loop start loop signaling - Type C OPS registered port open end
LO -	Loop start loop signaling - open end function by customer or customer's end user
LR -	20 Hz automatic ringdown interface at customer with Company provided PLAR
LS -	Loop start loop signaling - closed end function by customer or customer's end user
- M	For terminating in central office located answering service concentrator
NO -	No signaling interface, transmission only
PR -	Protective relaying ²
RV - O	Reverse battery signaling, one way operation, originate by customer

Note 1: Text is shown as new due to reissue of all Tariff Sections. No changes in rates or regulations were made with this Filing.

Note 2: Available only for the transmission of audio tone protective relaying signals used in the protection of electric power systems during fault conditions.

BELLSOUTH
 TELECOMMUNICATIONS
 FLORIDA
 ISSUED: June 29, 2021
 BY: Joe York, President -FL
 Jacksonville, Florida

ACCESS SERVICES TARIFF

Third Revised Page 31
 Cancels Second Revised Page 31

EFFECTIVE: June 30, 2021

E7. DEDICATED ACCESS SERVICES

E7.3 Channel Interface and Network Channel Codes (Cont'd)

E7.3.1 Glossary of Channel Interface Codes and Options (Cont'd)

Code - Option	Definition	
- T	Reverse battery signaling, one way operation, terminate function by customer or customer's end user	
SF -	Single frequency signaling within VF band at either customer POT or customer's end user POT	
TF -	Telephotograph ² interface	(C)
TT -	Telegraph ² /teletypewriter interface at either customer POT or customer's end user POT	(C)
- 2	20.0 milliamperes	
- 3	3.0 milliamperes	
- 6	62.5 milliamperes	
	(DELETED)	
	(DELETED)	

E7.3.2 Impedance

The nominal reference impedance with which the channel will be terminated for the purpose of evaluating transmission performance:

Value (ohms)	Code(s)
110	0
150	1
600	2
900	3 ¹
135	5
75	6
124	7
Variable	8
100	9

Note 1: For those interface codes with a 4-wire transmission path at the customer designated POT, rather than a standard 900 ohm impedance, the code (3) denotes a customer provided transmission equipment termination. Such terminations were provided to customers in accordance with the FCC Docket No. 20099 Settlement Agreement.

Note 2: Effective June 30, 2021, this Service will no longer be available for purchase by new or existing customers. In addition, requests to move, add, change, or renew existing service arrangements will not be accepted. Following the expiration of a customer's existing term agreement, service will be provided on a month-to-month basis at the applicable Monthly rates until the service is discontinued. The Company currently plans to discontinue this service on or after June 30, 2024.

(N)
 |
 (N)

BELLSOUTH
TELECOMMUNICATIONS, INC.

ACCESS SERVICE TARIFF

Original Page 32

FLORIDA

ISSUED: July 1, 1996

EFFECTIVE: July 15, 1996

BY: Joseph P. Lacher, President - FL
Miami, Florida

E7. DEDICATED ACCESS SERVICES¹

(N)

E7.3 Channel Interface and Network Channel Codes (Cont'd)

E7.3.3 Digital Hierarchy Channel Interface Codes (4DS)

Customers selecting the channelized four-wire DS-1 or higher facility interface option at the customer designated premises will be requested to provide subsequent system and channel assignment data. The various digital bit rates in the digital hierarchy employ the channel interface code 4DS9, 4DS0 or 4DS6 plus the speed options indicated following:

Interface Code and Speed Option	Nominal Bit Rate (Mbps)	Digital Hierarchy Level
4DS9-15	1.544	DS1
4DS9-31	3.152	DS1C
4DS0-63	6.312	DS2
4DS6-44	44.736	DS3

E7.3.4 Service Designator/Network Channel Code Conversion Table

The purpose of this table is to show the relationship between the service designator codes (e.g. VG2, DA1, etc.) and the network channel codes that are used for various administrative purposes.

Service Designator Code	Network Channel Code
TG1	NW
TG2	NY
VG1	LB
VG2	LC
VG3	LD
VG4	LE
VG5	LF
VG6	LG
VG7	LH
VG8	LJ
VG9	LK
VG10	LN
VG11	LP
VG12	LR
TV3	TZ
DA1	XA
DA2	XB
DA3	XG

Note 1: Text is shown as new due to reissue of all Tariff Sections. No changes in rates or regulations were made with this Filing.

BELLSOUTH
TELECOMMUNICATIONS, INC.
FLORIDA

ACCESS SERVICES TARIFF

First Revised Page 33
Cancels Original Page 33

ISSUED: November 17, 1998
BY: Joseph P. Lacher, President -FL
Miami, Florida

EFFECTIVE: December 2, 1998

E7. DEDICATED ACCESS SERVICES

(T)

E7.3 Channel Interface and Network Channel Codes (Cont'd)**E7.3.4 Service Designator/Network Channel Code Conversion Table (Cont'd)**

Service Designator Code	Network Channel Code
DA4	XH
DA5	XE
DA6	YN
HC0	HS
HC1	HC
HC1C	HD
HC2	HE
HC3	HF
HC14T	HK-A
HC16T	HK-B

E7.4 Rate Regulations

This section contains the specific regulations governing the rates and charges that apply for Dedicated Access Services.

E7.4.1 Types of Rates and Charges

- A. There are *two* types of rates and charges. These are monthly rates and nonrecurring charges. The rates and charges are described as follows:

(C)

Monthly Rates

Monthly rates are flat recurring charges that apply each month or fraction thereof that a Dedicated Access Service is provided. Minimum periods are specified in E5.2.5.

BELLSOUTH
TELECOMMUNICATIONS
FLORIDA
ISSUED: June 29, 2021
BY: Joe York, President -FL
Jacksonville, Florida

ACCESS SERVICES TARIFF

Eighth Revised Page 34
Cancels Seventh Revised Page 34

EFFECTIVE: June 30, 2021

E7. DEDICATED ACCESS SERVICES**E7.4 Rate Regulations (Cont'd)****E7.4.1 Types of Rates and Charges (Cont'd)**

A. (Cont'd)

Digital Data Access³ Service and Derived Data Channel³ (a.k.a. BellSouth SPA Derived Data Channel) service are offered under two contract plans. Contract plan rates are available in payment periods from twenty-four to forty-two months² and in payment periods from forty-three to sixty months² under conditions specified in the Channel Services Payment Plan in E2.4 of this Tariff. (These payment periods are an exception to those listed in E2.4 of this Tariff.) Termination Liability charges will not apply for customer requests for moves of service under CSPP subject to the provisions set forth in E2.4.9.A.11. of this Tariff. However, a Termination Liability Charge is applicable at the date of termination if the customer terminates or disconnects the service prior to fulfilling the period of the contract plan except as specified in 2. following. The Termination Liability Charge is determined by multiplying the contracted monthly rate times the number of months in the contract plan, less the contracted monthly rate times the number of months the service has been installed, **multiplied by a factor. The factor is fifty percent (50%) for contracts that have been in effect twelve months (12) or less, or twenty percent (20%) for contracts that have been in effect longer than twelve months (12).** An example is provided in 1. following. (C)

The following list identifies the individual Dedicated Access Services provided under Section E7. of this Tariff which are eligible for credit of nonrecurring charges under "Service Installation Guarantee" found in E2.4.10 of this Tariff. Customers with these services are not eligible for the Service Installation Guarantee when the requested installation, move or rearrangement service order interval is four days or less as measured from the Application Date of the order.

- Voice Grade³ (a.k.a. BellSouth SPA DS0 VG), (C)
- Digital Data Access³ (a.k.a. BellSouth SPA Derived Data Channel) service¹, (C)
- High Capacity (a.k.a. BellSouth SPA High Capacity) service
- SMARTPath service (a.k.a. BellSouth SPA Shared Ring)

Provided, however, that the following services are not eligible for such credit.

- FlexServ service (a.k.a. BellSouth SPA Customer Reconfiguration)
 - BellSouth Metro Ethernet service
1. A customer subscribes to Digital Data Access³ (a.k.a. BellSouth SPA DS0 Digital Data) service using the twenty-four to forty-two month payment plan. The contract plan period is for thirty months. The subscriber terminates the service after twelve months. The total liability charge is thirty months times the monthly rate. The amount is then reduced to reflect the number of months the subscriber has had the service, which in this example is twelve months. Therefore, the Termination Liability Charge is **fifty percent (50%) of this amount** calculated as follows: (C)

$$\text{Termination Liability Charge} = .50 \times [(30 \text{ months} \times \text{monthly rate}) - (12 \text{ months} \times \text{monthly rate})]$$
 2. A Termination Liability Charge will not be applicable at the date of termination if the customer terminates or disconnects the service prior to fulfilling the period of the contract plan for customer requested changes to a higher order of service covered by the Channel Services Payment Plan as specified in E2.4.9.A.4.b. of this Tariff, or customer requested changes to services not covered by the Channel Services Plan that are offered by the Company under a contract payment plan provided that the applicable conditions set forth in E2.4.9.A.4.b. of this Tariff are satisfied.

Note 1: The Data Over Voice Channel optional feature is not eligible for such credit.

Note 2: Effective March 23, 2019, Customers may not: Convert, renew, or establish CSPPs for Derived Data Channel Service, Digital Data Access Service.

Note 3: Effective June 30, 2021, this Service will no longer be available for purchase by new or existing customers. In addition, requests to move, add, change, or renew existing service arrangements will not be accepted. Following the expiration of a customer's existing term agreement, service will be provided on a month-to-month basis at the applicable Monthly rates until the service is discontinued. The Company currently plans to discontinue this service on or after June 30, 2024.

(N)
|
(N)

BELLSOUTH
TELECOMMUNICATIONS
FLORIDA
ISSUED: March 15, 2024
BY: Joe York, President -FL
Jacksonville, Florida

ACCESS SERVICES TARIFF

Seventh Revised Page 35
Cancels Sixth Revised Page 35

EFFECTIVE: March 17, 2024

E7. DEDICATED ACCESS SERVICES**E7.4 Rate Regulations (Cont'd)****E7.4.1 Types of Rates and Charges (Cont'd)****A.** (Cont'd)

Contract rates are available for 1.544 Mbps High Capacity (a.k.a. BellSouth SPA High Capacity) service for variable periods, with rates based on lengths of 36 months^{2, 3}, 60 months^{2, 3}, or 84 months^{1, 2, 3} under conditions specified in the Channel Service Payment Plan in E2.4 of this Tariff. A Termination Liability Charge is applicable at the date of termination. The applicable charge will be equal to fifty percent of the following: the number of months remaining in the contract times the monthly contract rate. However, Termination Liability charges will not apply for customer requests for moves of service under CSPP subject to the provisions set forth in E2.4.9.A.11. preceding. (C)

Rates applicable to a month-to-month payment option are subject to Company initiated changes.

B. Nonrecurring Charges

Nonrecurring charges are one-time charges that apply for specific work activity (i.e., installation or change to an existing service). The types of nonrecurring charges that apply for Dedicated Access Services are: installation of service, installation of optional features and functions, and service rearrangements.

Note 1: Effective March 23, 2019, Customers may not: (1) Establish CSPPs greater than 36 months for High Capacity Service, and (2) Convert or renew CSPPs for High Capacity Service.

Note 2: Effective November 1, 2022, customers may not establish new term plans of greater than 24 months for High Capacity Service Channel Service Payment Plans.

Note 3: Effective March 17, 2024, customers may not establish new term plans of greater than month-to-month for High Capacity Service Channel Service Payment Plans. (N)

BELLSOUTH
TELECOMMUNICATIONS
FLORIDA
ISSUED: June 29, 2021
BY: Joe York, President -FL
Jacksonville, Florida

ACCESS SERVICES TARIFF

Third Revised Page 36
Cancels Second Revised Page 36

EFFECTIVE: June 30, 2021

E7. DEDICATED ACCESS SERVICES**E7.4 Rate Regulations (Cont'd)****E7.4.1 Types of Rates and Charges (Cont'd)****B. Nonrecurring Charges (Cont'd)****1. Installation of Service****a. Local Channels**

Nonrecurring charges apply to each Local Channel on each Dedicated Access Service installed. When one service is ordered and installed, it is billed at the First Service Installed rate. When more than one of the same type of service, between the same locations, for the same customer is ordered and installed at the same time, one at each location is billed at the First Service Installed Rate and the others are billed at the Additional Service Installed rate. If additional services are installed at a later date, then the First Service Installed rate and the Additional Service rate would apply to those services regardless of what service already existed.

b. Interoffice Channel Mileage

The nonrecurring charge for the Interoffice Channel mileage will be applied each time the Interoffice Channel rate element is applicable.

The nonrecurring charges for the Installation of Services are set forth in E7.5 following as nonrecurring charges for the Local Channel Rate Element and the Interoffice Channel Rate Element.

2. Installation of Optional Features and Functions

Nonrecurring charges apply for the installation of some of the optional features and functions available with Dedicated Access Services. The Initial nonrecurring charge applies if the feature or function is installed coincident with the primary service. The Subsequent nonrecurring charge applies if the feature or function is installed after the installation of the primary service.

One nonrecurring charge is applicable to bridging.

First and Additional nonrecurring charges are applicable to activate each individual Central Office Channel Interface of a DS1 or DS0 Basic Channelization System¹, and are in addition to the nonrecurring charges for the DS1 or DS0 Basic Channelization System¹. A "First" Central Office Channel Interface nonrecurring charge is applicable to the first Central Office Channel Interface installed coincident with the installation of a DS1 or DS0 Basic Channelization System¹, per service request. An "Additional" nonrecurring charge applies for each additional Central Office Channel Interface, of the same type, ordered and installed at the same location, for the same customer, at the same time, on the same order request. Future requests for a Central Office Channel Interface(s) on an existing DS1 or DS0 Basic Channelization System¹ will be treated as new requests and will require "First" and "Additional" Central Office Channel Interface nonrecurring charge application, in addition to any other applicable charge(s).

One nonrecurring charge is applicable for each individual DS1 level Central Office or Customer channel interface and is in addition to any other applicable charge(s).

The nonrecurring charges for the installation of optional features and functions are set forth in E7.5 following as nonrecurring charges for optional features and functions associated with the specific services.

Note 1: Effective June 30, 2021, this Service will no longer be available for purchase by new or existing customers. In addition, requests to move, add, change, or renew existing service arrangements will not be accepted. Following the expiration of a customer's existing term agreement, service will be provided on a month-to-month basis at the applicable Monthly rates until the service is discontinued. The Company currently plans to discontinue this service on or after June 30, 2024.

(C)

(C)

(N)

BELLSOUTH
TELECOMMUNICATIONS
FLORIDA
ISSUED: June 29, 2021
BY: Joe York, President -FL
Jacksonville, Florida

ACCESS SERVICES TARIFF

Third Revised Page 37
Cancels Second Revised Page 37

EFFECTIVE: June 30, 2021

E7. DEDICATED ACCESS SERVICES**E7.4 Rate Regulations (Cont'd)****E7.4.1 Types of Rates and Charges (Cont'd)****B. Nonrecurring Charges (Cont'd)****3. Service Rearrangements**

Service rearrangements are changes to existing (installed) services which do not result in either a change in the minimum period requirements as set forth in E5.2.5.E. or a change in the physical location of the point of the termination at a customer designated premises. Changes which result in the establishment of new minimum period obligations are treated as disconnects and starts. Changes in the physical location of the point of the termination are treated as moves and are described and charged for as set forth in E7.4.5 following. A change which results from a transfer of service is described and charged as set forth in 4. and E7.5.13 following.

The charge to the customer for the service rearrangement is dependent on whether the change is administrative only in nature or involves actual physical change to the service.

Administrative changes, identified as follows, will be made without charge(s) to the customer. Such changes require the continued provision and billing of the Dedicated Access Service to the same entity (i.e., customer remains responsible for all outstanding indebtedness for the Dedicated Access Service). Administrative changes are as follows:

- Change of customer name (i.e., the customer of record does not change but rather the customer of record changes its name -- e.g., AT&T-Long Lines to AT&T-Communications),
- Change of customer or customer's end user premises address when the change of address is to a result of a physical relocation of equipment,
- Change in billing data (name, address, or contact name or telephone number. The customer of record does not change).
- ~H~Change of customer circuit identification,
- Change of billing account number,
- Change of customer test line number,
- Change of customer or customer's end user contact name or telephone number, and
- Change of jurisdiction.

All other service rearrangements, including physical changes to existing services, will be charged for as follows:

- If the change involves the addition of other customer designated premises to an existing multipoint service, the nonrecurring charge for the Local Channel rate element will apply. The charge(s) will apply only for the location(s) that is being added.
- If the change involves the addition of an optional feature or function which has a separate nonrecurring charge, that nonrecurring charge will apply.
- If the change involves changing the type of signaling on a Voice Grade¹ (a.k.a. BellSouth SPA DS0 VG) service, a charge equal to the Voice Grade¹ (a.k.a. BellSouth SPA DS0 VG) Local Channel rate element nonrecurring charge will apply. The charge will apply per service termination affected.

(C)
(C)

Note 1: Effective June 30, 2021, this Service will no longer be available for purchase by new or existing customers. In addition, requests to move, add, change, or renew existing service arrangements will not be accepted. Following the expiration of a customer's existing term agreement, service will be provided on a month-to-month basis at the applicable Monthly rates until the service is discontinued. The Company currently plans to discontinue this service on or after June 30, 2024.

(N)
|
(N)

BELLSOUTH
TELECOMMUNICATIONS
FLORIDA

ACCESS SERVICES TARIFF

Sixth Revised Page 38
Cancels Fifth Revised Page 38

ISSUED: November 30, 2021
BY: Joe York, President -FL
Jacksonville, Florida

EFFECTIVE: December 1, 2021

E7. DEDICATED ACCESS SERVICES

E7.4 Rate Regulations (Cont'd)

E7.4.1 Types of Rates and Charges (Cont'd)

B. Nonrecurring Charges (Cont'd)

3. Service Rearrangements (Cont'd)

- If the change involves changing a customer's 1.544 Mbps high capacity service, as described in E7.2.9, to SMARTPath service (a.k.a. BellSouth SPA Shared Ring), the change will be considered a disconnect of the existing service and full nonrecurring charges apply for the SMARTPath service (a.k.a. BellSouth SPA Shared Ring). If the existing 1.544 Mbps high capacity service is provided under a Channel Services Payment Plan (CSPP) agreement, a change to SMARTPath service (a.k.a. BellSouth SPA Shared Ring) under CSPP will be considered an upgrade and termination liability charges will not apply.

- If the change involves changing (reconfiguring) an existing BellSouth Metro Ethernet¹ service Connection, appropriate charges provided in E7.4.32. (C)

- If the change involves the addition of a DS3 Network Interface Unit (NIU) to a SMARTRing² service (a.k.a. BellSouth SPA Dedicated Ring) the rates and charges shown in E13.3.25. (C)

- For all other changes, including a change of the customer of record involving no physical changes to the service provided or the addition of optional features without separate nonrecurring charges, a charge equal to a Local Channel rate element nonrecurring charge will apply. Only one such charge will apply per service, per change.

4. Transfer of Service

When a change in billing data (e.g., name, address, contact name, or telephone number) is requested in association with a change in the customer of record, transfer of service charges, as set forth in E7.5.13. Charges are applied on a Billing Account Number (BAN) and per circuit basis.

E7.4.2 Dedicated Access Services Capable of Using the Local Exchange Network

A. General

When a Dedicated Access Line, intraLATA interexchange private line or Private Bypass facility is connected to a device capable of interconnecting the Dedicated Access line, intraLATA interexchange private line or Private Bypass facility to the Local Exchange Network, the Exchange Service Rate associated with that device (e.g., the PBX trunk in the case of a PBX) will be rated as Message or Measured Service as specified in the Local Exchange Company's General Subscriber Service Tariff.

B. Application of Measured or Message Service

Application of Measured or Message exchange service charges for services existing on the effective date of this Tariff will commence March 16, 1986, unless the certification process described in E7.4.2.C. following is met on or before February 8, 1986. For new Dedicated Access services, intraLATA interexchange private line or Private Bypass facilities ordered on or after the effective date of this Tariff and terminating for an end user at the same address at which a PBX trunk or other similar exchange service is also provided, that exchange service will automatically be rated on a Measured or Message basis unless the certification process described in C. following is met. Measured or Message service rates will be applied at the discretion of the Local Exchange Company for exchange services not certified by the process described in E7.4.2.C.

Note 1: Per Filing T20210063, effective on or after August 22, 2021, this Service will no longer be available for purchase by new or existing customers. In addition, requests to move, add, change, or renew existing service arrangements will not be accepted. Following the expiration of a customer's existing term agreement, service will be provided on a month-to-month basis at the applicable Monthly rates until the service is discontinued. The Company currently plans to discontinue this service on or after March 31, 2023. (N)

Note 2: Effective on or after December 1, 2021, neither new nor existing customers will be permitted to purchase new SMARTRing Service (Service). In addition, (A) Service Payment Plans greater than 12-months in length will no longer be available; and (B) requests to move, add, change, upgrade, or downgrade existing service arrangements will not be accepted, with the following exceptions: (1) existing customers will be permitted to modify their existing Service and will be able to add new circuits to their existing Service, but will not be permitted to add new nodes in any locations; and (2) any such new circuits will be subject to the customer's existing term payment plan or term agreement for the Service to which they are added. Following the expiration of a customer's existing term agreement, Service will be provided on a month-to-month basis at the applicable Month-to-Month rates until the Service is discontinued. (N)

Effective November 30, 2023, unless specified to the contrary in their existing Service agreements, existing customers may not renew Term Payment Plans or term agreements for Service. In addition, no move, add, or change orders of any type will be accepted. (N)

BELLSOUTH
TELECOMMUNICATIONS
FLORIDA

ACCESS SERVICES TARIFF

Sixth Revised Page 39
Cancels Fifth Revised Page 39

ISSUED: November 30, 2021
BY: Joe York, President -FL
Jacksonville, Florida

EFFECTIVE: December 1, 2021

E7. DEDICATED ACCESS SERVICES

E7.4 Rate Regulations (Cont'd)

E7.4.2 Dedicated Access Services Capable of Using the Local Exchange Network (Cont'd)

C. Certification Process

The certification will be in the form of a written notification to the Company certifying that calls are not completed into the Local Exchange Network over the Dedicated Access line, intraLATA interexchange private line or Bypass Facility. The notification may be provided (1) on or before February 8, 1986, for service existing on the effective date, (2) at the time new service is ordered or (3) at such time the Dedicated Access service, intraLATA interexchange private line or Bypass Facility is reterminated to a device not capable of interconnecting to the local exchange network. If a written certification is not received at the time an order for service is placed, message/measured exchange service will apply. Exempt status will become effective on the date certification is received by the Company.

D. Change of Status

The Company will cease billing message/measured exchange service rates when certification that the service has become exempt as set forth in C., preceding is received.

E7.4.3 Reserved for Future Use

E7.4.4 Minimum Periods

The minimum service periods are specified in E5.2.6 of this Tariff, except for SMARTPath service (a.k.a. BellSouth SPA Shared Ring), BellSouth Metro Ethernet¹ service and SmartRing² service (a.k.a. BellSouth Dedicated Ring) whose minimum service period is 4 months. (C)

The minimum service period for High Capacity ICB (a.k.a. BellSouth SPA High Capacity) services is specified in the Individual Case Basis Filing.

E7.4.5 Moves

A move involves a change in the physical location of one of the following:

- The Point of Termination at the customer's premises
- The customer's premises

The charges for the move are dependent on whether the move is to a new location within the same building or to a different building.

A. Moves Within the Same Building

When the move is to a new location within the same building, the charge for the move will be an amount equal to one half of the nonrecurring (i.e., installation) charge for the service termination affected. There will be no change in the minimum period requirements.

Note 1: Per Filing T20210063, effective on or after August 22, 2021, this Service will no longer be available for purchase by new or existing customers. In addition, requests to move, add, change, or renew existing service arrangements will not be accepted. Following the expiration of a customer's existing term agreement, service will be provided on a month-to-month basis at the applicable Monthly rates until the service is discontinued. The Company currently plans to discontinue this service on or after March 31, 2023. (N)

Note 2: Effective on or after December 1, 2021, neither new nor existing customers will be permitted to purchase new SMARTRing Service (Service). In addition, (A) Service Payment Plans greater than 12-months in length will no longer be available; and (B) requests to move, add, change, upgrade, or downgrade existing service arrangements will not be accepted, with the following exceptions: (1) existing customers will be permitted to modify their existing Service and will be able to add new circuits to their existing Service, but will not be permitted to add new nodes in any locations; and (2) any such new circuits will be subject to the customer's existing term payment plan or term agreement for the Service to which they are added. Following the expiration of a customer's existing term agreement, Service will be provided on a month-to-month basis at the applicable Month-to-Month rates until the Service is discontinued. (N)

Effective November 30, 2023, unless specified to the contrary in their existing Service agreements, existing customers may not renew Term Payment Plans or term agreements for Service. In addition, no move, add, or change orders of any type will be accepted. (N)

BELLSOUTH
TELECOMMUNICATIONS, INC.

ACCESS SERVICE TARIFF

FLORIDA
ISSUED: July 1, 1996
BY: Joseph P. Lacher, President - FL
Miami, Florida

EFFECTIVE: July 15, 1996

E7. DEDICATED ACCESS SERVICES¹

(N)

E7.4 Rate Regulations (Cont'd)

E7.4.5 Moves (Cont'd)

B. Moves to a Different Building

Moves to a different building (customer premises) in a wire center serving area different than the customer's existing serving wire center serving area, other than addressed in C. following, will be treated as a discontinuance and start of service and all associated nonrecurring charges will apply. Service will not be available simultaneously at both the original and new locations. New minimum period requirements may be established for the rearranged services in accordance with the regulations for the service. The customer will also remain responsible for satisfying all outstanding minimum period charges for the discontinued service. When the move involves a multipoint service, the nonrecurring charge will apply per rate element affected.

Moves to a Company-provided EIS interconnection arrangement, where the customer's and interconnector's existing wire center is the same, will be treated as a service move rather than a discontinuance and start of service. Cross connect rates, nonrecurring charges, and optional feature and function charges as contained in Section E20. following, will apply. In addition, service reconfiguration charges are applicable per customer request and per circuit moved as contained in E7.5.12 following. Individual services will not be available simultaneously at both the original premises location and new wire center interconnection space. Additional cooperative end-to-end testing is available and will be conducted by the Company when requested at rates and charges contained in E13.3.5 following. New minimum period requirements may be established for the rearranged services in accordance with the regulations for a service. The customer will remain responsible for satisfying all outstanding minimum period charges for the original service locations. When the move involves a multipoint service, the nonrecurring charge will apply per rate element affected.

Moves to a different building (customer premises) in the customer's existing serving wire center serving area will be treated as a service move rather than a discontinuance and start of service. Nonrecurring charges for the new local channel will apply as well as any optional feature and function charges for that local channel. In addition, service reconfiguration charges are applicable per customer request and circuit moved as contained in E7.5.12 following. Service will not be available simultaneously at both the original and new customer locations. Additional cooperative end-to-end testing is available and will be conducted by the Company at a customer's request at rates and charges contained in E13.3.5 following. New minimum period requirements may be established for the rearranged services in accordance with the regulations for a service. The customer will also remain responsible for satisfying all outstanding minimum period charges for the original service locations. When the move involves a multipoint service, the nonrecurring charge will apply per rate element affected.

C. Moves of Service(s) under CSPP

Customer requests for moves of service under CSPP, other than inside moves, will be subject to the conditions stated in E2.4.9.A.8. preceding.

E7.4.6 Mileage Measurement

The mileage to be used to determine the monthly rate for the Interoffice Channel is calculated on the airline distance between the locations involved, i.e., the serving wire centers associated with two customer designated premises, a serving wire center associated with a customer designated premises and a Company Hub, and a serving wire center associated with a customer designated premises, or two Company Hubs. The serving wire center associated with a customer designated premises is the serving wire center from which the customer designated premises would normally obtain dial tone.

Note 1: Text is shown as new due to reissue of all Tariff Sections. No changes in rates or regulations were made with this Filing.

BELLSOUTH
TELECOMMUNICATIONS
FLORIDA

ACCESS SERVICES TARIFF

Third Revised Page 41
Cancels Second Revised Page 41

ISSUED: June 29, 2021
BY: Joe York, President -FL
Jacksonville, Florida

EFFECTIVE: June 30, 2021

E7. DEDICATED ACCESS SERVICES

E7.4 Rate Regulations (Cont'd)

E7.4.6 Mileage Measurement (Cont'd)

Mileage is shown in E7.5 following in terms of mileage bands. To determine the rate to be billed, first compute the mileage using the V&H coordinates method, as set forth in the National Exchange Carrier Association Tariff FCC. No. 4, then find the band into which the computed mileage falls and apply the rates shown for that band. When the calculation results in a fraction of a mile, always round up to the next whole mile before determining the mileage band and applying the rates.

When Hubs are involved, mileage is computed and rates applied separately for each section of the Interoffice Channel, i.e., customer designated premises serving wire center to Hub, Hub to Hub and/or Hub or customer designated premises serving wire center. However, when any service is routed through a Hub for purposes other than customer specified bridging or channelization (e.g., the Company chooses to so route for test access purposes), rates will be applied only to the distance calculated between the serving wire centers associated with the IC or End User designated premises. For the purpose of applying multipoint charges, the bridging or hubbing locations are determined by that combination of airline distances connecting the serving wire center which will produce the lowest interoffice mileage charges.

SMARTRing[®] service (a.k.a. BellSouth Dedicated Ring) Local Channel, Alternate Central Office Channel and Internodal Channel rates are also distance sensitive. They are measured per quarter airline mile or fraction thereof from the customer's designated premises to the Serving Wire Center, Alternate Central Office, or other Customer Nodes. V&H coordinates are derived for each customer location through the use of longitude and latitude measurements. Using the V&H coordinate method as set forth in the NATIONAL EXCHANGE CARRIER ASSOCIATION, INC. TARIFF FCC. No. 4, compute the mileage, convert to quarter miles, and multiply the appropriate per quarter mile rate by the distance involved. Any portion of a quarter mile will always round up to the next quarter mile before determining the mileage and applying the rate.

The SMARTRing[®] service (a.k.a. BellSouth Dedicated Ring) Interoffice Channel mileage is calculated per quarter airline mile between two directly connected central office's on the ring. Interoffice Channel mileage is computed by using the V&H coordinates method as set forth in the NATIONAL EXCHANGE CARRIER ASSOCIATION, INC. TARIFF FCC. No. 4. To determine the rate to be billed, multiply the appropriate per quarter mile rate by the distance involved. Fractions of a quarter mile always round up to the next quarter mile before determining the mileage and applying the rate.

E7.4.7 Facility Hubs

A customer has the option of ordering digital high capacity facilities (i.e., DS1, DS1C, DS2 or DS3) to a facility Hub for channelizing to individual services requiring lower capacity facilities (e.g., Voice¹, etc.).

Different locations may be designated as Hubs for different facility capacities, e.g., channelization from digital to digital may occur at one location while channelization from digital to analog may occur at a different location. When ordering, the customer will specify the desired channelization Hub(s) selected from the National Exchange Carrier Association Tariff FCC. No. 4. This Tariff identifies the type(s) of channelization functions which are available and the serving wire centers at which they are available.

Some of the types of channelization available include the following:

- from higher to lower bit rate
- from digital to voice frequency channels

End to end services may be provided on channels of these facilities to a hub. The transmission performance for the end to end service provided between customer designated premises will be that of the lower capacity or bit rate. For example, when a 1.544 Mbps facility is channelized to voice frequency channels, the transmission performance of the channelized services will be Voice Grade¹ (a.k.a. BellSouth SPA DS0 VG), not High Capacity (a.k.a. BellSouth SPA High Capacity).

Note 1: Effective June 30, 2021, this Service will no longer be available for purchase by new or existing customers. In addition, requests to move, add, change, or renew existing service arrangements will not be accepted. Following the expiration of a customer's existing term agreement, service will be provided on a month-to-month basis at the applicable Monthly rates until the service is discontinued. The Company currently plans to discontinue this service on or after June 30, 2024.

BELLSOUTH
TELECOMMUNICATIONS
FLORIDA

ACCESS SERVICES TARIFF

Fourth Revised Page 42
Cancels Third Revised Page 42

ISSUED: June 29, 2021
BY: Joe York, President -FL
Jacksonville, Florida

EFFECTIVE: June 30, 2021

E7. DEDICATED ACCESS SERVICES

E7.4 Rate Regulations (Cont'd)

E7.4.7 Facility Hubs (Cont'd)

The Company will commence billing the monthly rate for the facility to the Hub on the date specified by the customer on the service order. Individual services utilizing these facilities may be installed coincident with the installation of the facility to the Hub or may be ordered and/or installed at a later date, at the option of the customer. The customer will be billed for a digital Local Channel, Interoffice Channel (when applicable) and the Basic Channelization System at the time the facility is installed. DS1 and DS0 Basic Channelization Systems¹ require a Central Office Channel Interface for activation of each lesser capacity channel. DS3 to DS1 channelization arrangements, for transport of intrastate DS1 service high capacity channels via LightGate (a.k.a. BellSouth SPA Point to Point Network) and SMARTRing services (a.k.a. BellSouth Dedicated Ring), require a DS1 channel interface for activation of each DS1 channel. Individual service rates (by service type) will apply for a Local Channel and additional Interoffice Channel and Central Office Channel Interface(s) (as required) for each channelized service. These will be billed to the customer as each individual service is installed. (C)

Cascading channelization occurs when a digital channel is channelized to provide channels with a lesser capacity and one of the lesser capacity channels is further channelized. For example, a High Capacity (a.k.a. BellSouth SPA High Capacity) facility is channelized to individual Voice Grade¹ (a.k.a. BellSouth SPA DS0 VG) channels. (C)

When cascading channelization is performed, whether in the same or a different Hub, a charge for the additional Basic Channelization System and Central Office Channel Interface(s) also applies. A DS1 Basic Channelization System and DDAS¹ (a.k.a. BellSouth SPA DS0 Digital Data) Central Office Channel Interface are required for high speed or low speed DDAS¹ (a.k.a. BellSouth SPA DS0 Digital Data) activations when channelized from a DS1 (1.544 Mbps) channel. A DS0 Basic Channelization System¹ and Subrate Central Office Channel Interface¹ are required for subrate¹ activations of 2.4, 4.8 and 9.6 Kbps when channelized from a DS0¹ (64 Kbps) channel. When cascading channelization is performed at different Hubbing locations, Interoffice Channel charges also apply between the Hubs. (C)

E7.4.8 Shared Use Analog and Digital High Capacity (a.k.a. BellSouth SPA High Capacity) Services

Shared use occurs when Dedicated Access Services and BellSouth SWA are provided over the same High Capacity (a.k.a. BellSouth SPA High Capacity) facility through a common interface. The facility will be ordered and rated as Dedicated Access Services (i.e., Local Channel, Interoffice Channel, as appropriate, and Basic Channelization System and Central Office Interface(s), if applicable) until such time as the customer chooses to use a portion of the available capacity for providing BellSouth SWA as set forth in E5.2.8 *of this Tariff*. As each individual channel is activated for BellSouth SWA, the Dedicated Access Local Channel rates, Interoffice Channel rates, and Basic Channelization System rates, if applicable, will be reduced accordingly. For SMARTPath service (a.k.a. BellSouth SPA Shared Ring) the rates will be reduced by 1/48th for each BellSouth SWA VG Circuit. The customer must place an order for each individual Switched or Dedicated Access Service utilizing the Shared Use Facilities and specify the channel assignment for each such service. BellSouth SWA rates and charges as set forth in E6.8 *of this Tariff* will apply for each channel of the shared use facility that is used to provide BellSouth SWA. Where Dedicated Access Service is provided utilizing a channel(s) of the shared use facility to the Hub, High Capacity (a.k.a. BellSouth SPA High Capacity) rates and charges will apply for the facility to the Hub as set forth preceding and individual service rates and charges will apply from the Hub to the customer designated premises. The rates and charges that will apply to the portion from the Hub to the customer designated premises will be dependent on the specific type of Dedicated Access Service that is provided (e.g., Voice Grade¹ (a.k.a. BellSouth SPA DS0 VG), Digital Data Access¹ (a.k.a. BellSouth SPA DS0 Digital Data) service, etc.). The applicable rates and charges will include a Local Channel and Interoffice Channel, if applicable. (C)

Access Collocation Cross-Connects provide a means for customers to interconnect their BellSouth Shared Use and Digital High Capacity (a.k.a. BellSouth SPA High Capacity) services to Central Office Collocation arrangements within the same Central Office. Terms, conditions, and rates for Physical Access Collocation Cross-Connects and Virtual Access Collocation Cross-Connects are set forth in Section E13. of this Tariff.

The capability exists for a customer to utilize all or part of a SMARTRing service (a.k.a. BellSouth Dedicated Ring) to transport switched access provided the SMARTRing service (a.k.a. BellSouth Dedicated Ring) channel interface transporting the BellSouth SWA service does not have FlexServ service (a.k.a. BellSouth SPA Customer Reconfiguration) capability. The customer must place an order for each individual BellSouth SWA Channel provided over Dedicated Access service Shared Use Facilities and specify the channel assignment for each such service. The switched traffic would enter and exit the SMARTRing service (a.k.a. BellSouth Dedicated Ring) at Customer and Central Office Nodes on that network. When this occurs, ratcheting of Dedicated Access rate elements (i.e. Nodes, Channel Interfaces, Local Channels, Alternate Central Office Channels, Internodal Channels, or Interoffice Channels) will be based on the number of voice grade¹ (a.k.a. BellSouth SPA DS0 VG) equivalent trunks/lines of that rate element used for BellSouth SWA access. (C)

Note 1: Effective June 30, 2021, this Service will no longer be available for purchase by new or existing customers. In addition, requests to move, add, change, or renew existing service arrangements will not be accepted. Following the expiration of a customer's existing term agreement, service will be provided on a month-to-month basis at the applicable Monthly rates until the service is discontinued. The Company currently plans to discontinue this service on or after June 30, 2024. (N)

(N)
|
(N)

BELLSOUTH
TELECOMMUNICATIONS
FLORIDA
ISSUED: June 29, 2021
BY: Joe York, President -FL
Jacksonville, Florida

ACCESS SERVICES TARIFF

First Revised Page 42.1
Cancels Original Page 42.1

EFFECTIVE: June 30, 2021

E7. DEDICATED ACCESS SERVICES**E7.4 Rate Regulations (Cont'd)****E7.4.8 Shared Use Analog and Digital High Capacity (a.k.a. BellSouth SPA High Capacity) Services (Cont'd)**

Reduction factors will be developed to reduce the charges on system level billing as well as the billing on individual DS1, DS3, STS-1, OC-3, and/or OC-12 Channel Interfaces. For ratcheting purposes, the system level charges include Customer Nodes, Central Office Nodes, Local Channels, Alternate Central Office Channels, Internodal Channels, and Interoffice Channels as appropriate to make up a customer's SMARTRing® service (a.k.a. BellSouth Dedicated Ring). Individual OC-1, OC-3 and OC-12 Channel Interfaces used in Overlay Ring Arrangements will be ratcheted as system level charges. The system reduction factor will apply to the system level charges.

The system reduction factor will be derived by dividing the number of activated BellSouth SWA access circuits by the voice grade¹ (a.k.a. BellSouth SPA DS0 VG) channel equivalent capacity of the self-healing ring. An OC-1 SMARTRing® service (a.k.a. BellSouth Dedicated Ring) has 672 voice grade¹ (a.k.a. BellSouth SPA DS0 VG) equivalent channels. An OC-3 SMARTRing® service (a.k.a. BellSouth Dedicated Ring) has 2,016 voice grade¹ (a.k.a. BellSouth SPA DS0 VG) equivalent channels. An OC-3+ or OC-12 SMARTRing® service (a.k.a. BellSouth Dedicated Ring) has 8,064 voice grade¹ equivalent channels. An OC-48 SMARTRing® service (a.k.a. BellSouth Dedicated Ring) or OC-48+ SMARTRing® service (a.k.a. BellSouth Dedicated Ring) with 48 or less activated DS3s has 32,256 voice grade¹ (a.k.a. BellSouth SPA DS0 VG) equivalent channels. However, when an OC-48+ SMARTRing® service (a.k.a. BellSouth Dedicated Ring) is used to transport BellSouth SWA service, and more than 48 equivalent DS3s are activated on the service, the factor will be based upon the actual number of activated DS3s times 672 DS0s. A factor for individual DS3 channel interfaces and 28 DS1 channel systems, will be derived by dividing the number of activated BellSouth SWA access circuits associated with the DS3 channel by the voice grade¹ (a.k.a. BellSouth SPA DS0 VG) equivalent capacity of the DS3 channel. A DS3 has 672 voice grade¹ (a.k.a. BellSouth SPA DS0 VG) equivalent channels. For DS1 channel interfaces, a factor is derived by dividing the number of BellSouth SWA access circuits associated with the DS1 channel by the voice grade¹ (a.k.a. BellSouth SPA DS0 VG) equivalent capacity of the DS1 channel, which is 24. Each reduction factor is rounded to four decimal places and then multiplied against the respective monthly charges to determine the reduction amount.

BellSouth SWA rates and charges as set forth in E6.8 preceding will apply for each channel of the shared use facility that is used to provide BellSouth SWA.

Where Dedicated Access service is provided utilizing a channel(s) of the shared use facility to the Hub, Wideband Analog¹ (a.k.a. BellSouth SPA Wideband Analog) or High Capacity (a.k.a. BellSouth SPA High Capacity) rates and charges will apply for the portion of the facility ordered as Dedicated Access to the Hub as set forth preceding and individual service rates and charges will apply from the Hub to the customer designated premises for the Dedicated Access services ordered. The rates and charges that will apply to the portion from the Hub to the customer designated premises will be dependent on the specific type of Dedicated Access service that is provided (e.g., Voice Grade¹ (a.k.a. BellSouth SPA DS0 VG), Telegraph¹ (a.k.a. BellSouth SPA Telegraph), etc.). The applicable rates and charges will include a local channel, interoffice channel, if applicable. Rates and charges for optional features and functions associated with the service, if any, will apply as set forth in E7.5 following.

Note 1: Effective June 30, 2021, this Service will no longer be available for purchase by new or existing customers. In addition, requests to move, add, change, or renew existing service arrangements will not be accepted. Following the expiration of a customer's existing term agreement, service will be provided on a month-to-month basis at the applicable Monthly rates until the service is discontinued. The Company currently plans to discontinue this service on or after June 30, 2024.

BELLSOUTH
TELECOMMUNICATIONS
FLORIDA
ISSUED: February 14, 1997
BY: Joe York, President -FL
Jacksonville, Florida

ACCESS SERVICES TARIFF

First Revised Page 43
Cancels Original Page 43

EFFECTIVE: March 1, 1997

E7. DEDICATED ACCESS SERVICES (T)**E7.4 Rate Regulations (Cont'd)****E7.4.9 Reserved for Future Use****E7.4.10 Reserved for Future Use****E7.4.11 Reserved for Future Use****E7.4.12 FlexServ® Service (a.k.a. BellSouth SPA Customer Reconfiguration)** (T)

A. General

FlexServ® service (*a.k.a. BellSouth SPA Customer Reconfiguration*) is an optional feature that enables the customer to monitor and reconfigure his Voice Grade (*a.k.a. BellSouth SPA DS0 VG*), DDAS (*a.k.a. BellSouth SPA DS0 Digital Data*), and High Capacity (*a.k.a. BellSouth SPA High Capacity*) dedicated access services without the direct intervention of Company personnel. (T)

1. Basic FlexServ® Service (*a.k.a. BellSouth SPA Customer Reconfiguration*) (T)

Basic FlexServ® service (*a.k.a. BellSouth SPA Customer Reconfiguration*) includes monitoring and reconfiguration of the customer's private line services equipped with FlexServ® service (*a.k.a. BellSouth SPA Customer Reconfiguration*). (T)

Monitoring consists of unsolicited signals of major and minor facility alarms. These alarms include carrier group alarms, out of service alarms, bit error rate, bipolar violations, slip errors, errored seconds, out-of-frame alarms and invalid connections. Invalid connections are connections between special access services with incompatible signals or between services without FlexServ® service (*a.k.a. BellSouth SPA Customer Reconfiguration*). Customer requests for such connections will be denied. The Company shall not be responsible for service interruptions, troubles, loss of customer data, or any other losses resulting from attempted invalid connections. (T)

Reconfiguration provides the customer with the ability to direct the Company to connect or disconnect circuits equipped with FlexServ® service (*a.k.a. BellSouth SPA Customer Reconfiguration*) options to or from each others of like kind at a central office or central offices where the customer has purchased FlexServ® service (*a.k.a. BellSouth SPA Customer Reconfiguration*). Such connections and disconnections may be performed immediately or at a future time prescribed by the customer and are performed without direct interaction by Company personnel. (T)

The customer is responsible for providing the terminal equipment required for access to FlexServ® service (*a.k.a. BellSouth SPA Customer Reconfiguration*). (T)

The customer may transmit reconfiguration directions to or receive monitoring information from the Company over a switched service or a private line service. There are several types of access to the service listed in the General Subscriber Service Tariff from which the customer may choose. The type of access chosen will indicate the type of service the customer must provide to a Company location. Each FlexServ® service (*a.k.a. BellSouth SPA Customer Reconfiguration*) customer must purchase at least one type of access. (T)

Outside of the Company exchange or region, the customer must provide service from his terminal location to the designated Company location from which he may receive monitoring information or transmit reconfiguration directions.

With the customer's initial order for basic FlexServ® service (*a.k.a. BellSouth SPA Customer Reconfiguration*), the Company provides the capability for "User Access" for monitoring and reconfiguration signals. One customer identification code with password security is included with such access. (T)

BELLSOUTH
TELECOMMUNICATIONS, INC.
FLORIDA

ACCESS SERVICES TARIFF

Third Revised Page 44
Cancels Second Revised Page 44

ISSUED: January 12, 2005
BY: Joseph P. Lacher, President -FL
Miami, Florida

EFFECTIVE: January 27, 2005

E7. DEDICATED ACCESS SERVICES

E7.4 Rate Regulations (Cont'd)

E7.4.12 FlexServ Service (a.k.a. BellSouth SPA Customer Reconfiguration) (Cont'd)

A. General (Cont'd)

1. Basic FlexServ Service (a.k.a. BellSouth SPA Customer Reconfiguration) (Cont'd)

With the customer's initial order, the Company provides one customer training class for up to five (5) persons. The class length of this initial training is two consecutive eight hour days. These training classes are conducted at a designated Company location. Transportation, lodging and food for the attendees will be the responsibility of the customer. If the customer desires for the initial training to be conducted on his premises, then the customer is responsible for the transportation, lodging and food for the trainer. In addition, the customer is responsible for having the appropriate equipment on his premises.

Reconfiguration and monitoring are not available during the performance of routine maintenance of the Company's facilities and equipment used to provide FlexServ service (a.k.a. BellSouth SPA Customer Reconfiguration).

The Local and Interoffice Channels, which are terminated into FlexServ service (a.k.a. BellSouth SPA Customer Reconfiguration) are subject to all regulations and charges contained in their respective sections of this Tariff in addition to those contained herein.

Different switching options may be available in the same central office. If customers desire more than one switching option in the same central office and facilities are available, a channel connection is required for each FlexServ service (a.k.a. BellSouth SPA Customer Reconfiguration) switching option connected.

FlexServ service (a.k.a. BellSouth SPA Customer Reconfiguration) is furnished only in serving wire centers where facilities are available.

2. Customer Circuits

There are **three** types of channel connections, which can be connected to FlexServ service (a.k.a. BellSouth SPA Customer Reconfiguration) - DS0 (Single channel), DS1 (1.544 Mbps) **and DS3 (44.736 Mbps) digital circuits.**

DS0 Channel Connections - There are two types of DS0 channel connections - Voice Grade (a.k.a. BellSouth SPA DS0 VG) and Digital (a.k.a. BellSouth SPA DS0 Digital Data). Both types of DS0 connections will be switched at a DS0 level.

DS1 Channel Connections - There are two types of connections available for a customer desiring to terminate a DS1 circuit - DS0 switching and DS1 switching. For example, if a customer needs to be able to monitor or reconfigure the 24 DS0 circuits riding on the DS1 channel, then the customer would purchase a DS1 channel connection with DS0 switching. If the customer does not need access to the individual DS0 circuits, then the customer would purchase a DS1 channel connection with DS1 switching. **A monitoring only option (i.e., surveillance) is also provided for DS1 channel connections. This option may also be used for terminating SWA DS1 channels.**

DS3 Channel Connections (Monitoring Only) - There are two types of connections available for terminating a DS3 circuit - DS1 and DS3. This option provides for termination of SWA and SPA DS3 channels for monitoring purposes only (i.e., surveillance). If the customer needs monitoring for 28 DS1 circuits, then the customer would purchase a DS3 channel connection at DS1 level. The customer would purchase a DS3 channel connection at DS3 level if the customer wants to monitor the entire DS3 circuit.

3. FlexServ Service (a.k.a. BellSouth SPA Customer Reconfiguration) Options

a. Additional Concurrent User Access: This option provides the customer the ability to establish additional concurrent connections to the Company for the communication of monitoring and reconfiguration signals. One additional customer identification code is provided with each additional User Access. For each Additional Concurrent User Access ordered, the customer must also order an additional Management Terminal Interface from the General Subscriber Service Tariff.

b. Additional User Identification Codes: This option provides customer identification codes in addition to that provided with each User Access. If the customer has a Dial Access to FlexServ service (a.k.a. BellSouth SPA Customer Reconfiguration), then the customer must also order an additional Security Card from the General Subscriber Service Tariff.

BELLSOUTH
TELECOMMUNICATIONS
FLORIDA
ISSUED: February 14, 1997
BY: Joe York, President -FL
Jacksonville, Florida

ACCESS SERVICES TARIFF

First Revised Page 45
Cancels Original Page 45

EFFECTIVE: March 1, 1997

E7. DEDICATED ACCESS SERVICES (T)**E7.4 Rate Regulations (Cont'd)****E7.4.12 FlexServ® Service (a.k.a. BellSouth SPA Customer Reconfiguration) (Cont'd)** (T)

A. General (Cont'd)

3. FlexServ® Service Options (Cont'd)

- c. Additional Customer Training: This option provides one eight hour day of customer training in addition to that included with basic FlexServ® service (*a.k.a. BellSouth SPA Customer Reconfiguration*). These training classes are conducted at a designated Company location. All other terms that apply for the initial training apply for the subsequent training. (T)
- d. Multipoint Bridging: Multipoint Bridging is a capability which permits the cross connection of multiple channels equipped with FlexServ® service (*a.k.a. BellSouth SPA Customer Reconfiguration*). (T)
- (1) Multipoint Bridging, sometimes referred to as "DMB", is an option on voice grade service that allows the customer the capability to perform reconfigurations that cross-connect or bridge three or more channels in the FlexServ® service (*a.k.a. BellSouth SPA Customer Reconfiguration*) arrangement into one conferencing arrangement. (T)
- (2) Multipoint Junction Unit option gives the customer the ability to bridge one master and four patron legs for use with Digital Data Access (*a.k.a. BellSouth SPA DS0 Digital Data*) service. If more than one MJU is required. One of the four patron legs must be used to connect to the master leg of another MJU. The customer is responsible for this connection. The MJU feature is only offered in a unit of five channel connections (one master and four legs). (T)
- e. Subrate Reconfiguration Capability is an option that provides the customer the ability to control all ports of a subrate multiplexer within a FlexServ® service (*a.k.a. BellSouth SPA Customer Reconfiguration*) arrangement. This control includes both the DSOB channel and DS0A legs. The speeds for subrates are 2.4, 4.8, and 9.6 Kbps (does not include 19.2 Kbps). The customer has the responsibility to establish a subrate system using previously acquired DS0 ports. (T)
- f. Reconfigurations by Company Personnel: The customer may request that Company personnel intervene to perform reconfigurations that the customer could otherwise perform without the direct intervention of Company personnel. (T)

4. Shared FlexServ® Service (*a.k.a. BellSouth SPA Customer Reconfiguration*) Arrangement (T)

Multiple customers may include circuits with the FlexServ® service (*a.k.a. BellSouth SPA Customer Reconfiguration*) option in the same FlexServ® service (*a.k.a. BellSouth SPA Customer Reconfiguration*) arrangement, provided all customers designate in writing the same party to serve as their agent. (A FlexServ® service (*a.k.a. BellSouth SPA Customer Reconfiguration*) arrangement consists of all dedicated access services with FlexServ® service (*a.k.a. BellSouth SPA Customer Reconfiguration*) that can be monitored and reconfigured through the same User Access.) (T)

The agent will be authorized to represent each of those customers in all transactions and communications with the Company regarding the shared FlexServ® service (*a.k.a. BellSouth SPA Customer Reconfiguration*) arrangement or circuits included in that arrangement including reconfigurations, monitoring, ordering of additional dedicated access services and FlexServ® service (*a.k.a. BellSouth SPA Customer Reconfiguration*) options in the arrangement, and removal of dedicated access services from the arrangement. The Company will not process any customer orders or requests affecting that arrangement of circuits included in that arrangement except those submitted to the Company by the agent. (T)

BELLSOUTH
TELECOMMUNICATIONS
FLORIDA

ACCESS SERVICES TARIFF

Fourth Revised Page 46
Cancels Third Revised Page 46

ISSUED: November 30, 2021
BY: Joe York, President -FL
Jacksonville, Florida

EFFECTIVE: December 1, 2021

E7. DEDICATED ACCESS SERVICES

E7.4 Rate Regulations (Cont'd)

E7.4.12 FlexServ Service (a.k.a. BellSouth SPA Customer Reconfiguration) (Cont'd)

A. General (Cont'd)

4. Shared FlexServ Service (a.k.a. BellSouth SPA Customer Reconfiguration) Arrangement (Cont'd)

The Company will not be liable for any loss to any of the customers in a shared FlexServ service (a.k.a. BellSouth SPA Customer Reconfiguration) arrangement caused directly or indirectly by actions of the agent or another customer in the shared arrangement. Each customer in the shared arrangement and the agent indemnify the Company for the costs of any and all claims arising directly or indirectly out of the actions of the agent or another customer in the shared arrangement, including, but not limited to, the cost of defending against such claims.

Any customer in a shared FlexServ service (a.k.a. BellSouth SPA Customer Reconfiguration) arrangement must give the Company 30 days prior written notice of his intent to revoke an agent's authority or to remove his dedicated access services from a shared arrangement. Such notice shall not be effective unless it provides the Company with specific and sufficient directions regarding treatment of the customer's dedicated access services upon revocation of the agent's authority or removal from the shared arrangement.

5. Access Collocation Cross-Connects

Access Collocation Cross-Connects provide a means for customers to interconnect their FlexServ service (a.k.a. BellSouth SPA Customer Reconfiguration) to Central Office Collocation arrangements within the same Central Office. Terms, conditions, and rates for Physical Access Collocation Cross-Connects and Virtual Access Collocation Cross-Connects are set forth in Section E13. of this Tariff.

B. Application of Rates

1. Basic FlexServ Service (a.k.a. BellSouth SPA Customer Reconfiguration)

a. Connection of Dedicated Access Services to Reconfiguration and Alarm Monitoring Capability.

A DS0/DS1/DS3 nonrecurring Connection Charge and a recurring monthly rate is required for each entrance and exit of a dedicated access channel to reconfiguration and monitoring capability.

Charges for Access to FlexServ service (a.k.a. BellSouth SPA Customer Reconfiguration) are contained in E7.5.16 following.

2. FlexServ Service (a.k.a. BellSouth SPA Customer Reconfiguration) Options

a. Additional Concurrent User Access

For each Additional Concurrent User Access a nonrecurring charge and a recurring monthly rate applies.

b. Additional User Identification Codes

A nonrecurring charge applies for each additional ID requested.

c. Additional Customer Training

Any additional training will incur a nonrecurring charge for each eight (8) hour day of training.

d. Multipoint Bridging

Multipoint Bridging (DMB)

There will be a nonrecurring charge and a monthly rate for each DS0 or equivalent that is equipped with this capability.

Multipoint Junction Unit

A nonrecurring charge and a monthly rate applies for each DS0 or equivalent that is equipped with this capability.

This option must be purchased in groups of 5 because a unit has the capacity of 5 DS0 or equivalent channel connections.

e. Subrate Reconfiguration

There will be a nonrecurring charge for each DS0 equipped DS0B and a nonrecurring charge and a monthly rate will apply for each set of DS0As. The DS0A rates apply in sets of five for 9.6 Kbps, in sets of ten for 4.8 Kbps, and in sets of twenty for 2.4 Kbps. (M)

f. Reconfigurations by the Company Personnel

A nonrecurring charge is applicable on each occasion, when the customer requests Company personnel to perform a reconfiguration or a series of reconfigurations in order to set up point-to-point or multipoint connections, to provide a status report or to establish a conference. (M)

BELLSOUTH
TELECOMMUNICATIONS
FLORIDA
ISSUED: June 29, 2021
BY: Joe York, President -FL
Jacksonville, Florida

ACCESS SERVICES TARIFF

Sixth Revised Page 47
Cancels Fifth Revised Page 47

EFFECTIVE: June 30, 2021

E7. DEDICATED ACCESS SERVICES**E7.4 Rate Regulations (Cont'd)****E7.4.12 FlexServ Service (a.k.a. BellSouth SPA Customer Reconfiguration) (Cont'd)****B. Application of Rates (Cont'd)****2. FlexServ Service (a.k.a. BellSouth SPA Customer Reconfiguration) Options (Cont'd)****e. Subrate Reconfiguration**

There will be a nonrecurring charge for each DS0 equipped DS0B and a nonrecurring charge and a monthly rate will apply for each set of DS0As. The DS0A rates apply in sets of five for 9.6 Kbps, in sets of ten for 4.8 Kbps, and in sets of twenty for 2.4 Kbps.

f. Reconfigurations by the Company Personnel

A nonrecurring charge is applicable on each occasion, when the customer requests Company personnel to perform a reconfiguration or a series of reconfigurations in order to set up point-to-point or multipoint connections, to provide a status report or to establish a conference.

3. Contract Plans

Contract rates for FlexServ service (a.k.a. BellSouth SPA Customer Reconfiguration) are available in E7.5.16 under conditions specified in the Channel Services Payment Plan in E2.4 of this Tariff.

Termination Liability is applicable at the date of termination. The applicable charge will be *fifty percent (50%) for contracts that have been in effect twelve months (12) or less, or twenty percent (20%) for contracts that have been in effect longer than twelve months (12)*. Termination Liability will not apply for customer requests for moves of service under CSPP subject to the provisions set forth in E2.4.9.A.8 preceding.

E7.4.13 Derived Data Channel¹ Service (DDCS) (a.k.a. BellSouth SPA Derived Data Channel)**A. Application of Rates**

The derived data channel charges provide the central office data/voice multiplexing capability. The customer must also subscribe to a compatible two-wire local exchange line (e.g., business exchange line, ESSX service, Digital ESSX service, MultiServ service, MultiServ PLUS service, or BellSouth Centrex service main station line). This two-wire exchange line and its associated rates and charges are in addition to the derived data channel rates and charges.

The DS0-B interface charge is applicable for each group of a maximum of twenty multiplexed derived data channels. Each of the twenty channels in a DS0-B interface channel group operates at a bit rate of 2.4 Kbps. The interoffice channel is required when the customer's serving wire center and the serving wire center of the customer's terminating premises are not the same.

E7.4.14 SMARTRing service (a.k.a. BellSouth Dedicated Ring)**A. Self-healing Multi-nodal Alternate Route Topology Ring**

1. Monthly rates and charges as specified in E7.5.18 following apply for each SMARTRing service (a.k.a. BellSouth Dedicated Ring). Customers must specify network capacity at the time of the initial order. In an Overlay Ring Arrangement where a customer's overlaying SMARTRing service (a.k.a. BellSouth Dedicated Ring) rides the customer's host SMARTRing service (a.k.a. BellSouth Dedicated Ring), the overlay ring will share the transport of the host ring between common node locations. Rate categories at OC-3, OC-3+, OC-12, OC-24, OC-48, OC-48+, OC-192 and OC-192+ capacity levels include Customer Nodes, Central Office Nodes, Local Channels, Alternate Central Office Channels, Interoffice Channels and Internodal Channels. OC-24 SMARTRing service (a.k.a. BellSouth Dedicated Ring) is only available to existing CSPP customers or under month-to-month arrangements. Rate categories for OC-1 SMARTRing service (a.k.a. BellSouth Dedicated Ring) include Customer Nodes and Central Office Nodes. Channel Interfaces are required at each node on the network and must be associated with a SMARTRing service (a.k.a. BellSouth Dedicated Ring). An OC-1 Overlay Ring Arrangement requires an OC-1 Channel Interface at each node involved. An OC-3 Overlay Ring Arrangement requires an OC-3 Channel Interface at each node involved. An OC-3+ or OC-12 Overlay Ring Arrangement requires an OC-12 Channel Interface at each node involved. An OC-48 or OC-48+ Overlay Ring Arrangement requires an OC-48 Channel Interface at each node involved. In Overlay Ring Arrangements, the customer must order a Channel Interface for each entry to or exit from the host ring. In all other situations, the number of Channel Interfaces ordered will depend on whether the customer desires a working interface, or a working interface and a protection interface. The quantity of channel interfaces ordered may not exceed the capacity ordered. When a 28 DS1 Channel System is utilized to activate DS1 channels, the appropriate number of DS1 Channel Interfaces are required in lieu of an originating or terminating DS3 or STS-1 Channel Interface.

Note 1: Effective June 30, 2021, this Service will no longer be available for purchase by new or existing customers. In addition, requests to move, add, change, or renew existing service arrangements will not be accepted. Following the expiration of a customer's existing term agreement, service will be provided on a month-to-month basis at the applicable Monthly rates until the service is discontinued. The Company currently plans to discontinue this service on or after June 30, 2024.

(C)

(N)

(N)

BELLSOUTH
TELECOMMUNICATIONS
FLORIDA

ACCESS SERVICES TARIFF

Second Revised Page 47.1
Cancels First Revised Page 47.1

ISSUED: November 30, 2021
BY: Joe York, President -FL
Jacksonville, Florida

EFFECTIVE: December 1, 2021

E7. DEDICATED ACCESS SERVICES

E7.4 Rate Regulations (Cont'd)

E7.4.14 SMARTRing[®] service (a.k.a. BellSouth Dedicated Ring) (Cont'd)

(C)

- A. Self-healing Multi-nodal Alternate Route Topology Ring (Cont'd)
2. Nonrecurring charges for Local, Alternate Central Office, Interoffice and Internodal Channels apply for each channel for month-to-month customers. Nonrecurring charges are not applicable when the ring level rate elements and channel interfaces are ordered under TPP arrangements. SMARTRing[®] service (a.k.a. BellSouth Dedicated Ring) ring level rate elements are defined as following: Local Channel, Interoffice Channel, Internodal Channel, Alternate Central Office Channel, Customer Node and Central Office Node. Nonrecurring charges do apply for the Channel Interface Reallocation rate element and the SMARTRing[®] service (a.k.a. BellSouth Dedicated Ring) rearrangement rate elements (Surveillance and Reconfiguration) for CSPP and TPP customers. When the customer requests two separate routes and the routing is provided as described in E7.2.16.A preceding, charges apply for the Local Channels and any Interoffice Channels on the requested route. Recurring charges for Local, Alternate Central Office, Interoffice and Internodal Channels apply for each quarter air mile increment of the channel. Fractions of a quarter mile will always round up to the next quarter air mile before determining the mileage and applying the rate. For channels which are less than one quarter mile, a minimum charge of one quarter mile applies.
 3. For Internodal Channels, charges apply as appropriate either for the same wire center area or contiguous serving wire center areas, as specified in E7.5 18.A.4.
 4. Nonrecurring charges for Customer Nodes and Central Office Nodes apply per node for month-to-month customers and are based upon the capacity of the ring configuration. Nonrecurring charges are not applicable when the preceding rate elements are ordered under TPP arrangements. Recurring rates for Customer and Central Office Nodes apply per node and are also based upon the capacity of the ring configuration.
 5. When the customer orders an OC-1 SMARTRing[®] service (a.k.a. BellSouth Dedicated Ring) Overlay Ring Arrangement riding the customer's host OC-12, OC-48, or OC-48+ SMARTRing[®] service (a.k.a. BellSouth Dedicated Ring), recurring charges apply per OC-1 Customer Node and/or OC-1 Central Office Node, in addition to the recurring and nonrecurring charges for associated Channel Interfaces.
 6. When the customer orders an OC-3 SMARTRing[®] service (a.k.a. BellSouth Dedicated Ring) service Overlay Ring Arrangement riding the customer's host OC-12, OC-48, OC-48+, OC-192 or OC-192+ SMARTRing[®] service (a.k.a. BellSouth Dedicated Ring), recurring charges apply per OC-3 Customer Node and/or OC-3 Central Office Node, in addition to the recurring and nonrecurring charges for associated Channel Interfaces. Nonrecurring charges only apply for month-to-month customers.
 7. When the customer orders an OC-3+ or OC-12 Overlay Ring Arrangement riding the customer's host OC-48, OC-48+, OC-192 or OC-192+ SMARTRing[®] service (a.k.a. BellSouth Dedicated Ring), recurring charges apply per OC-3+ and/or OC-12 Customer Node and/or per OC-3+ and/or OC-12 Central Office Node, in addition to the charges for associated Channel Interfaces. Nonrecurring charges only apply for month-to-month customers.
 8. In all Overlay Ring Arrangements, the number of OC-1, OC-3, and/or OC-12 Channel Interfaces required will be based upon the characteristics of the overlaying ring.
 9. The rates for Customer Channel Interfaces apply for each origination and for each termination of an activated DS1, DS3, STS-1, OC-3, OC-12, OC-48 and/or 1000 Mbps at the Customer Node. For interfaces ordered on a month-to-month basis the nonrecurring charge applies per interface. For interfaces ordered under CSPP, nonrecurring charges are established on a per order basis for the first DS1, DS3, STS-1, OC-3 and/or OC-12 which originates or terminates at a Customer Node and for each additional DS1, DS3, STS-1, OC-3, and/or OC-12 which originates or terminates at the same Customer Node. For interfaces ordered under TPP, there are no nonrecurring charges associated with the installation. The recurring rate applies on a per Customer Node basis for each origination and for each termination of an activated DS3 and/or DS1 at a Customer Node.

Note 1: Effective on or after December 1, 2021, neither new nor existing customers will be permitted to purchase new SMARTRing Service (Service). In addition, (A) Service Payment Plans greater than 12-months in length will no longer be available; and (B) requests to move, add, change, upgrade, or downgrade existing service arrangements will not be accepted, with the following exceptions: (1) existing customers will be permitted to modify their existing Service and will be able to add new circuits to their existing Service, but will not be permitted to add new nodes in any locations; and (2) any such new circuits will be subject to the customer's existing term payment plan or term agreement for the Service to which they are added. Following the expiration of a customer's existing term agreement, Service will be provided on a month-to-month basis at the applicable Month-to-Month rates until the Service is discontinued.

(M)

(N)

Effective November 30, 2023, unless specified to the contrary in their existing Service agreements, existing customers may not renew Term Payment Plans or term agreements for Service. In addition, no move, add, or change orders of any type will be accepted.

(N)

BELLSOUTH
TELECOMMUNICATIONS
FLORIDA

ACCESS SERVICES TARIFF

Second Revised Page 47.2
Cancels First Revised Page 47.2

ISSUED: November 30, 2021
BY: Joe York, President -FL
Jacksonville, Florida

EFFECTIVE: December 1, 2021

E7. DEDICATED ACCESS SERVICES

E7.4 Rate Regulations (Cont'd)

E7.4.14 SMARTRing¹ service (a.k.a. BellSouth Dedicated Ring) (Cont'd)

- (C)
- A. Self-healing Multi-nodal Alternate Route Topology Ring (Cont'd)
10. In addition, OC-12 and or OC-48 customers with DS3 and/or STS-1 interfaces at the Customer Node electing to connect with DS1 services at a Central Office Node, must obtain a 28 DS1 Channel System and the appropriate number of DS1 Channel Interfaces in lieu of a DS3 or STS-1 Channel Interface. A maximum of 28 DS1 Channel Interfaces can be activated for each 28 DS1 Channel System utilized. For service ordered under CSPP, nonrecurring charges are established on a per order basis for the first 28 DS1 Channel System and for each additional 28 DS1 Channel System at that same Central Office Node. Nonrecurring charges are also established for the first DS1 Channel Interface which originates/terminates in a 28 DS1 Channel System and each additional DS1 Channel Interface which originates/terminates in that same DS1 Channel System. For DS1 Channel Systems ordered under TPP, nonrecurring charges do not apply. For DS1 Channel Systems ordered on a month-to-month basis, nonrecurring charges apply. The recurring rate applies for each 28 DS1 Channel System and each DS1 Channel Interface activated per Central Office Node. (M1)
11. A nonrecurring charge applies for SMARTRing service (a.k.a. BellSouth Dedicated Ring) Surveillance, one for each Customer Node and each Central Office Node, per SMARTRing service (a.k.a. BellSouth Dedicated Ring) rearranged. A nonrecurring charge applies for Reconfiguration, one per reconfiguration of each STS-1 group at each node where such reconfiguration capability is desired. These rate elements apply when the Customer adds FlexServ service (a.k.a. BellSouth SPA Customer Reconfiguration) to an existing SMARTRing service (a.k.a. BellSouth Dedicated Ring) as set forth in E7.2.16.A preceding. Reconfiguration is not available with 100 Mbps and 1000 Mbps BellSouth Metro Ethernet Backbone interfaces.
12. For CSPP customers, first and additional nonrecurring charges will be applied when ordering the same rate element between the same locations with the same installation date. First and additional nonrecurring charges are not applicable under TPP arrangements.
13. SMARTRing service (a.k.a. BellSouth Dedicated Ring) purchased prior to August 23, 1996, is available under several CSPP arrangements: Plan A (24-48 Months¹), Plan B (49-72 Months¹) or Plan C (73-96 Months¹). Renewals of existing SMARTRing service (a.k.a. BellSouth Dedicated Ring) or purchases of new SMARTRing service (a.k.a. BellSouth Dedicated Ring) on or after August 23, 1996, will only be available under TPP arrangements. In order to accommodate more flexible customer situations, SMARTRing service (a.k.a. BellSouth Dedicated Ring) is available under several TPP arrangements: Plan A (12-36 Months¹), Plan B (37-60 Months¹) or Plan C (61-96 Months¹). Month-to-month arrangements (with a minimum of four months) are available for SMARTRing service (a.k.a. BellSouth Dedicated Ring). (C)
14. CSPP and TPP arrangements are provided under the terms and conditions specified in E2.4.9 preceding, except as modified following. For all payment plans, the following regulations apply:
- a. SMARTRing service (a.k.a. BellSouth Dedicated Ring), whether initially or subsequently ordered in conjunction with BellSouth Dedicated Ring, must be provided under the same TPP payment plan with the same service period and both services are to be coterminous.
- b. All rate elements, for a given SMARTRing service (a.k.a. BellSouth Dedicated Ring), whether initially or subsequently ordered, must be provided under the same payment plan with the same service period and are coterminous upon disconnect of the SMARTRing service (a.k.a. BellSouth Dedicated Ring). However, Channel Interfaces, except those utilized to interface an overlaying ring with its host ring, may be provided under a month-to-month arrangement which is equal to or less than the payment plan for the associated SMARTRing service (a.k.a. BellSouth Dedicated Ring). Customers with Channel Interfaces provided under a CSPP payment period which began prior to August 22, 1994, may convert those Channel Interfaces to a month-to-month or payment plan arrangement which is equal to or less than the payment plan for the associated SMARTRing service (a.k.a. BellSouth Dedicated Ring), at the current rates and charges. (M2)
- Note 1:** Effective on or after December 1, 2021, neither new nor existing customers will be permitted to purchase new SMARTRing Service (Service). In addition, (A) Service Payment Plans greater than 12-months in length will no longer be available; and (B) requests to move, add, change, upgrade, or downgrade existing service arrangements will not be accepted, with the following exceptions: (1) existing customers will be permitted to modify their existing Service and will be able to add new circuits to their existing Service, but will not be permitted to add new nodes in any locations; and (2) any such new circuits will be subject to the customer's existing term payment plan or term agreement for the Service to which they are added. Following the expiration of a customer's existing term agreement, Service will be provided on a month-to-month basis at the applicable Month-to-Month rates until the Service is discontinued. (N)
- Effective November 30, 2023, unless specified to the contrary in their existing Service agreements, existing customers may not renew Term Payment Plans or term agreements for Service. In addition, no move, add, or change orders of any type will be accepted. (N)

M1 Material appearing on this page previously appeared on page(s) 47.1 of this section.

M2 Material previously appearing on this page now appears on page(s) 47.3 of this section.

BELLSOUTH
TELECOMMUNICATIONS
FLORIDA

ACCESS SERVICES TARIFF

First Revised Page 47.3
Cancels Original Page 47.3

ISSUED: November 30, 2021
BY: Joe York, President -FL
Jacksonville, Florida

EFFECTIVE: December 1, 2021

E7. DEDICATED ACCESS SERVICES

E7.4 Rate Regulations (Cont'd)

E7.4.14 SMARTRing[®] service (a.k.a. BellSouth Dedicated Ring) (Cont'd)

(C)

A. Self-healing Multi-nodal Alternate Route Topology Ring (Cont'd)

14. (Cont'd)

c. In a shared network arrangement, where the host subscriber and the connecting service user subscribes to services under CSPP or TPP arrangements, the payment periods for directly associated channelized rate elements must be equal to or less than the payment periods for the host service, or the service user must order those rate elements under month-to-month payment terms. Where the host subscriber receives services under month-to-month payment terms, a connecting user must also receive directly associated channelized rate elements under month-to-month payment terms. (M)

15. The rates applicable to a month-to-month payment plan are subject to Telephone Company initiated charges. (M)

16. For CSPP customers, a termination liability charge will be applicable if services are disconnected prior to the end of the chosen service period. The applicable charge is equal to the number of months remaining in the rate stabilized service period times 60 percent of the monthly rates for SMARTRing service (a.k.a. BellSouth Dedicated Ring) which includes all Nodes, Channel Interfaces, Local Channels, Alternate Central Office Channels, Internodal Channels and/or Interoffice Channels provided under the CSPP arrangement. (M)

Termination liability charges for SMARTRing service (a.k.a. BellSouth Dedicated Ring) TPP customers are applicable as specified in E2.4.9.C preceding. (M)

17. When a service period under an existing CSPP or TPP arrangement is completed and a customer elects to revert to a month-to-month payment option, no minimum period is applicable. (M)

18. The TPP customer of record will have a 60 day grace period after which month-to-month rates will apply. (M)

19. Customers may upgrade from a lower capacity SMARTRing[®] service (a.k.a. BellSouth Dedicated Ring) to a higher capacity SMARTRing[®] service (a.k.a. BellSouth Dedicated Ring) without incurring any termination charges if the following conditions are met:

a. the order for the upgraded SMARTRing[®] service (a.k.a. BellSouth Dedicated Ring) and the order for the disconnect of the existing SMARTRing[®] service (a.k.a. BellSouth Dedicated Ring) are received by the Telephone Company at the same time,

b. the new SMARTRing[®] service (a.k.a. BellSouth Dedicated Ring) is provided between the same customer and Central Office locations as the discontinued SMARTRing[®] service (a.k.a. BellSouth Dedicated Ring),

c. the number of Channel Interfaces activated under the new capacity SMARTRing[®] service (a.k.a. BellSouth Dedicated Ring) is greater than the number of Channel Interfaces activated under the existing capacity SMARTRing[®] service (a.k.a. BellSouth Dedicated Ring).

d. the expiration date of the new SMARTRing[®] service (a.k.a. BellSouth Dedicated Ring) payment plan is subsequent to the payment plan of the ring being discontinued.

20. Customers may also upgrade existing SMARTRing[®] service (a.k.a. BellSouth Dedicated Ring) to a new SMARTRing[®] service (a.k.a. BellSouth Dedicated Ring) of the same capacity without incurring a termination liability charge, if the customer is concurrently ordering a new capability which cannot be provisioned with the existing SMARTRing[®] service (a.k.a. BellSouth Dedicated Ring) and if the conditions set forth in 19. preceding are met.

21. Ring level billing is defined as billing for the following rate elements: Local Channel, Interoffice Channel, Internodal Channel Alternate Central Office Channel, Customer Node and Central Office Node. Billing for Customer Channel Interfaces and Central Office Channel Interfaces recurring and nonrecurring charges will be effective upon activation to the SMARTRing[®] service (a.k.a. BellSouth Dedicated Ring).

22. If the Service Establishment Date extends beyond one year from the customer's order date due to Telephone Company reasons, the preceding conversion provisions apply. If the Service Establishment Date extends beyond one year from the customer's order date for other reasons, the preceding conversion provisions do not apply and billing for all recurring and nonrecurring charges will be effective with the Service Establishment Date.

Note 1: Effective on or after December 1, 2021, neither new nor existing customers will be permitted to purchase new SMARTRing Service (Service). In addition, (A) Service Payment Plans greater than 12-months in length will no longer be available; and (B) requests to move, add, change, upgrade, or downgrade existing service arrangements will not be accepted, with the following exceptions: (1) existing customers will be permitted to modify their existing Service and will be able to add new circuits to their existing Service, but will not be permitted to add new nodes in any locations; and (2) any such new circuits will be subject to the customer's existing term payment plan or term agreement for the Service to which they are added. Following the expiration of a customer's existing term agreement, Service will be provided on a month-to-month basis at the applicable Month-to-Month rates until the Service is discontinued. (N)

Effective November 30, 2023, unless specified to the contrary in their existing Service agreements, existing customers may not renew Term Payment Plans or term agreements for Service. In addition, no move, add, or change orders of any type will be accepted. (N)

BELLSOUTH
TELECOMMUNICATIONS
FLORIDA

ACCESS SERVICES TARIFF

Sixth Revised Page 48
Cancels Fifth Revised Page 48

ISSUED: October 10, 2014
BY: Joe York, President -FL
Jacksonville, Florida

EFFECTIVE: October 11, 2014

E7. DEDICATED ACCESS SERVICES**E7.4 Rate Regulations (Cont'd)****E7.4.15 Zone Pricing**

- A. High Capacity (a.k.a. BellSouth SPA DS1) service (1.544 Mbps) is organized into three pricing zones. Rate levels for the Local Channel, Interoffice Channels and DS1 Basic Channelization will be billed in accordance with the pricing zone assignment of the serving wire center. The pricing zone assignment for each Company serving wire center is specified in the National Exchange Carrier Association (NECA) Tariff F.C.C. No. 4. Interoffice Channels, which terminate in offices in different zones will carry the higher rate. When interoffice channels are provided by more than one Telephone Company, this Company's portion of the circuit will be billed at the Zone Rate of this Company's central office, and the other Telephone Company's portion of that circuit will be billed in accordance with that Company's tariff, pursuant to E2.4.8. Channelization rates will be determined by the location of the channelization arrangement.

E7.4.16 Reserved for Future Use

(T)
(D)

(D)

BELLSOUTH
TELECOMMUNICATIONS
FLORIDA

ACCESS SERVICES TARIFF

Fourth Revised Page 48.1
Cancels Third Revised Page 48.1

ISSUED: November 30, 2021
BY: Joe York, President -FL
Jacksonville, Florida

EFFECTIVE: December 1, 2021

E7. DEDICATED ACCESS SERVICES

E7.4 Rate Regulations (Cont'd)

E7.4.16 (DELETED)

E7.4.17 SMARTPath Service (a.k.a. BellSouth SPA Shared Ring)

A. Application of Rates

Monthly rates and charges as specified in E7.5.17 apply for each SMARTPath service (a.k.a. BellSouth SPA Shared Ring). The transport provided within a SMARTPath service (a.k.a. BellSouth SPA Shared Ring) Area is provided at 1.544 Mbps. Rate categories include a SMARTPath service (a.k.a. BellSouth SPA Shared Ring) Area Connection, and a SMARTPath service (a.k.a. BellSouth SPA Shared Ring) Area Junction.

The SMARTPath service (a.k.a. BellSouth SPA Shared Ring) Area Connection rate element provides for the connection at the designated premises where the customer gains access to SMARTPath service (a.k.a. BellSouth SPA Shared Ring) and transport to a designated junction on the network. The SMARTPath service (a.k.a. BellSouth SPA Shared Ring) Area Junction rate element provides for the connection between the SMARTPath service (a.k.a. BellSouth SPA Shared Ring) network and (1) another customer designated premises, in the same SMARTPath service (a.k.a. BellSouth SPA Shared Ring) Area or (2) a serving wire center in the same SMARTPath service (a.k.a. BellSouth SPA Shared Ring) Area for connection to (a) DS1 Basic Channelization, FlexServ service (a.k.a. BellSouth SPA Customer Reconfiguration), Virtual Expanded Interconnection Services under Section E20. SMARTRing² service (a.k.a. BellSouth Dedicated Ring or DS3 service as provided in Section E7, or (b) a SMARTPath service (a.k.a. BellSouth SPA Shared Ring) Area Junction of another SMARTPath service (a.k.a. BellSouth SPA Shared Ring) area in the same Metropolitan Area. (C)

Recurring and nonrecurring charges apply for each SMARTPath service (a.k.a. BellSouth SPA Shared Ring) Area Connection and SMARTPath service (a.k.a. BellSouth SPA Shared Ring) Area Junction.

SMARTPath service (a.k.a. BellSouth SPA Shared Ring) is available under several payment plans: Month-to-month (with a 4 month minimum), Plan A (24-48 Months)¹, or Plan B (49-72 Months)¹. Plan A and Plan B are provided under conditions specified in the Channel Services Payment Plan (CSPP) E2.4.9.A.

The rates applicable to a month-to-month payment plan are subject to Company initiated changes. Rates stabilized under CSPP are exempt from Company initiated increases, however, decreases for any rate element will automatically flow through to the customer.

A SMARTPath service (a.k.a. BellSouth SPA Shared Ring) performance credit, as specified in E2.4.4.B will apply.

A termination liability charge will be applicable if services provided under a CSPP arrangement are disconnected prior to the end of the chosen service period. The termination charge is equal to the applicable rate per rate element for the current contract multiplied by the difference in months between the time the CSPP contract has been in effect and the minimum contract length multiplied times a factor. The factor is 50 percent for contracts that have been in effect twelve months or less, or 20 percent for contracts that have been in effect longer than twelve months.

Note 1: Effective March 23, 2019, Customers may not convert, renew, or establish CSPPs longer than 36 months for SMARTPath Service.

Note 2: Effective on or after December 1, 2021, neither new nor existing customers will be permitted to purchase new SMARTRing Service (Service). In addition, (A) Service Payment Plans greater than 12-months in length will no longer be available; and (B) requests to move, add, change, upgrade, or downgrade existing service arrangements will not be accepted, with the following exceptions: (1) existing customers will be permitted to modify their existing Service and will be able to add new circuits to their existing Service, but will not be permitted to add new nodes in any locations; and (2) any such new circuits will be subject to the customer's existing term payment plan or term agreement for the Service to which they are added. Following the expiration of a customer's existing term agreement, Service will be provided on a month-to-month basis at the applicable Month-to-Month rates until the Service is discontinued. (N)

Effective November 30, 2023, unless specified to the contrary in their existing Service agreements, existing customers may not renew Term Payment Plans or term agreements for Service. In addition, no move, add, or change orders of any type will be accepted. (N)

BELLSOUTH
TELECOMMUNICATIONS, INC.
FLORIDA
ISSUED: February 4, 2005
BY: Joseph P. Lacher, President -FL
Miami, Florida

ACCESS SERVICES TARIFF

Original Page 48.2

EFFECTIVE: March 7, 2005

E7. SPECIAL ACCESS (A.K.A. BELLSOUTH SPA) SERVICE

E7.4 Rate Regulations (Cont'd)

- E7.4.18 Reserved For Future Use** (N)
- E7.4.19 Reserved For Future Use** (N)
- E7.4.20 Reserved For Future Use** (N)
- E7.4.21 Reserved For Future Use** (N)
- E7.4.22 Reserved For Future Use** (N)
- E7.4.23 Reserved For Future Use** (N)
- E7.4.24 Reserved For Future Use** (N)
- E7.4.25 Reserved For Future Use** (N)
- E7.4.26 Reserved For Future Use** (N)
- E7.4.27 Reserved For Future Use** (N)
- E7.4.28 Reserved For Future Use** (N)
- E7.4.29 Reserved For Future Use** (N)
- E7.4.30 Reserved For Future Use** (N)
- E7.4.31 Reserved For Future Use** (N)

BELLSOUTH
TELECOMMUNICATIONS
FLORIDA

ACCESS SERVICES TARIFF

Fourth Revised Page 48.3
Cancels Third Revised Page 48.3

ISSUED: August 20, 2021
BY: Joe York, President -FL
Jacksonville, Florida

EFFECTIVE: August 22, 2021

E7. SPECIAL ACCESS (A.K.A. BELLSOUTH SPA) SERVICE

E7.4 Rate Regulations (Cont'd)

E7.4.32 BellSouth Metro Ethernet Service¹

(C)

A. General

1. The minimum service period for BellSouth Metro Ethernet service is four (4) months.
2. Suspension of BellSouth Metro Ethernet service is not allowed.
3. BellSouth Metro Ethernet service is available 24 hours per day, 7 days per week, except for preventive maintenance.
Due to the nature of BellSouth Metro Ethernet service it will be necessary to perform preventive maintenance and software updates. This will mean that BellSouth Metro Ethernet service will be unavailable during the period of time when preventive maintenance is being performed. This could result in the service being unavailable during the period between 1:00 AM and 5:00 AM Eastern Time on Sundays and Wednesdays. However, the Company reserves the right to perform maintenance at any time at its discretion that it believes such maintenance is necessary. The Company will make a reasonable effort to provide notice to those customers likely to be affected by such maintenance work.
4. Obligations of customer and Company:
 - (a) The Company is not responsible for the installation, operation or maintenance of any equipment provided by the customer.
 - (b) The customer is responsible for the provision and maintenance of all customer provided equipment and to insure that the operating characteristics of this equipment is comparable with and does not interfere with the service offered by the Company.
 - (c) At the BellSouth Metro Ethernet service Connection point the customer's signals must conform to IEEE Standards 802.3, 802.3u or 802.3z. To meet end-to-end delay requirements contained in these aforementioned standards, the customer may be required to provide additional equipment.
5. In some cases, the Company and another Incumbent Local Exchange Company (ILEC) may agree to jointly provide a customer Metro Ethernet Service. The rates and charges for the BellSouth Metro Ethernet service Connection are applicable for such connectivity; charges for BellSouth Metro Ethernet Additional Mileage are also applicable when the mileage from the BellSouth/ILEC meet-point to the BellSouth Metro Ethernet wire center associated with the service is over ten (10) miles. The Company is only responsible for the ordering, provisioning, maintaining and billing of such service up to the meet-point (i.e., demarcation point with the ILEC). BellSouth Metro Ethernet service SLA credits shall only be applicable for the portion of the service provided within the territory of the Company; such credits are appropriate only for missed commitments determined to be the fault of the Company.

Note 1: Effective on or after August 22, 2021, this Service will no longer be available for purchase by new or existing customers. In addition, requests to move, add, change, or renew existing service arrangements will not be accepted. Following the expiration of a customer's existing term agreement, service will be provided on a month-to-month basis at the applicable Monthly rates until the service is discontinued. The Company currently plans to discontinue this service on or after March 31, 2023.

(N)
|
(N)

E7. SPECIAL ACCESS (A.K.A. BELLSOUTH SPA) SERVICE

E7.4 Rate Regulations (Cont'd)

E7.4.32 BellSouth Metro Ethernet Service¹

A. General (Cont'd)

- 6. Basic, Premium and Virtual BellSouth Metro Ethernet Service Connections of 10 Mbps or higher may alternatively be provided to a customer premises over the customer's SMARTRing² service (a.k.a. BellSouth SPA Dedicated Ring). (C)
 The customer is required to purchase the appropriate SMARTRing² service (a.k.a. BellSouth SPA Dedicated Ring) BellSouth Metro Ethernet Backbone interfaces that are a bandwidth equal to the bandwidth of the BellSouth Metro Ethernet Service backbone transport that is standard for the specific type and speed of BellSouth Metro Ethernet Service Connection serving that customer premises. (A chart is provided herein which sets forth the backbone bandwidth of each type and speed of BellSouth Metro Ethernet Service Connection.) Standard BellSouth Metro Ethernet Service features are available on such alternative arrangements, with the exception that Automatic Protection Switching is not available. (C)
 For such applications using SMARTRing² service (a.k.a. BellSouth SPA Dedicated Ring) as alternate transport, the BellSouth Metro Ethernet Service Connection will provide data channel transport to connect the termination of the SMARTRing² service (a.k.a. BellSouth SPA Dedicated Ring) at the central office node, to the BellSouth Metro Ethernet Service wire center associated with the BellSouth Metro Ethernet Service Connection (i.e., the central office of the Metro Ethernet Service switch). (C)
 When the SMARTRing² service (a.k.a. BellSouth SPA Dedicated Ring) central office node is located greater than 10 miles from the BellSouth Metro Ethernet Service wire center, BellSouth Metro Ethernet Service Additional Mileage charges will also be applicable. (C)
 For BellSouth Metro Ethernet Service Connections utilizing the customer's LightGate service or SMARTRing² service as alternate transport, the committed bandwidth for select speeds will be as shown in BellSouth Technical Reference TR-73632. (C)

Metro Ethernet Connection	Metro Ethernet Backbone Bandwidth
Basic 10 Mbps	100 Mbps (1 STS-1)
Basic 100 Mbps	100 Mbps (3 STS-1)
Basic 1000 Mbps	1000 Mbps
Premium 10, 20, 50 Mbps (Fixed)	100 Mbps (1 STS-1)
Premium 10, 20, 50 Mbps (Burst)	100 Mbps (3 STS-1)
Premium 100Mbps (Fixed)	Fractional 1000 Mbps at 150 Mbps
Premium 250 Mbps (Fixed)	Fractional 1000 Mbps at 300 Mbps
Premium 500 Mbps (Fixed)	Fractional 1000 Mbps at 600 Mbps
Premium 100, 250, 500 Mbps (Burst)	1000 Mbps
Virtual 10, 20, 50 Mbps	100 Mbps (1 STS-1)
Virtual 80 Mbps	100 Mbps (3 STS-1)
Virtual 100 Mbps	Fractional 1000 Mbps at 150 Mbps
Virtual 200, 300 Mbps	Fractional 1000 Mbps at 300 Mbps
Virtual 450 Mbps	Fractional 1000 Mbps at 450 Mbps
Virtual 600 Mbps	Fractional 1000 Mbps at 600 Mbps
Virtual750,900 Mbps	1000 Mbps

- 7. In some cases, the Telephone Company and an Independent Telephone Company (ICO) may agree to jointly provide a customer Metro Ethernet Service. The rates and charges for the BellSouth Metro Ethernet Service Connection are applicable for such connectivity; charges for BellSouth Metro Ethernet Additional Mileage are also applicable when the mileage from the BellSouth/ICO meet-point to the BellSouth Metro Ethernet wire center associated with the service is over 10 miles. The Telephone Company is only responsible for the ordering, provisioning, maintaining and billing of such service up to the meet-point (i.e., demarcation point with the ICO). BellSouth Metro Ethernet Service SLA credits shall only be applicable for the portion of the service provided within the territory of the Telephone Company; such credits are appropriate only for missed commitments determined to be the fault of the Telephone Company.

Note 1: Effective on or after August 22, 2021, this Service will no longer be available for purchase by new or existing customers. In addition, requests to move, add, change, or renew existing service arrangements will not be accepted. Following the expiration of a customer's existing term agreement, service will be provided on a month-to-month basis at the applicable Monthly rates until the service is discontinued. The Company currently plans to discontinue this service on or after March 31, 2023.

Note 2: Effective on or after December 1, 2021, neither new nor existing customers will be permitted to purchase new SMARTRing Service (Service). In addition, (A) Service Payment Plans greater than 12-months in length will no longer be available; and (B) requests to move, add, change, upgrade, or downgrade existing service arrangements will not be accepted, with the following exceptions: (1) existing customers will be permitted to modify their existing Service and will be able to add new circuits to their existing Service, but will not be permitted to add new nodes in any locations; and (2) any such new circuits will be subject to the customer's existing term payment plan or term agreement for the Service to which they are added. Following the expiration of a customer's existing term agreement, Service will be provided on a month-to-month basis at the applicable Month-to-Month rates until the Service is discontinued. (N)

Effective November 30, 2023, unless specified to the contrary in their existing Service agreements, existing customers may not renew Term Payment Plans or term agreements for Service. In addition, no move, add, or change orders of any type will be accepted. (N)

BELLSOUTH
TELECOMMUNICATIONS
FLORIDA

ACCESS SERVICES TARIFF

Sixth Revised Page 48.4
Cancels Fifth Revised Page 48.4

ISSUED: August 20, 2021
BY: Joe York, President -FL
Jacksonville, Florida

EFFECTIVE: August 22, 2021

E7. SPECIAL ACCESS (A.K.A. BELLSOUTH SPA) SERVICE

E7.4 Rate Regulations (Cont'd)

E7.4.32 BellSouth Metro Ethernet Service (Cont'd)¹

(C)

B. Rate Categories and Regulations

1. The following rate categories apply for BellSouth Metro Ethernet service. Applicable rates and charges are provided in E7.5.22 following.
 - (a) Basic BellSouth Metro Ethernet service Connection
 - (b) Premium BellSouth Metro Ethernet service Connection
 - (c) **(DELETE)**
 - (d) Virtual BellSouth Metro Ethernet service Connection
 - (e) BellSouth Metro Ethernet service Additional Mileage Charges
 - (f) Priority Plus Feature
 - (g) Q-Forwarding Feature
 - (h) VLAN Aggregation Feature
 - (i) **CNM** - Metro Ethernet Reporting Feature
 - (j) Class of Service (CoS) Profile
 - (k) Automatic Protection Switching Feature
 - (l) Service Reconfiguration Charge
 - (m) System Reconfiguration Charge
2. BellSouth Metro Ethernet service is available under month-to-month rates as provided in E7.5.22.A. following or under the optional Transport Payment Plan (TPP) (as described in E2.4.9.C. of this Tariff) to receive the TPP rates provided in E7.5.22.B. following.
3. BellSouth Metro Ethernet service Connections are provided utilizing various Ethernet equipment configurations referred to herein as "physical service types". The physical service type of each BellSouth Metro Ethernet Connection is provided in the chart in 5. following.
4. A hierarchy of the various BellSouth Metro Ethernet service Connections by capability (i.e., basic, premium and virtual) and speed is provided in the chart in 5. following. This chart provides a higher order of service ranking that is utilized to determine the appropriate nonrecurring charges for service reconfiguration requests. This ranking is also utilized to determine if termination liability is applicable for specific reconfiguration requests if the service is under a TPP term commitment.

Note 1: Effective on or after August 22, 2021, this Service will no longer be available for purchase by new or existing customers. In addition, requests to move, add, change, or renew existing service arrangements will not be accepted. Following the expiration of a customer's existing term agreement, service will be provided on a month-to-month basis at the applicable Monthly rates until the service is discontinued. The Company currently plans to discontinue this service on or after March 31, 2023.

(N)

(N)

BELLSOUTH
 TELECOMMUNICATIONS
 FLORIDA
 ISSUED: August 20, 2021
 BY: Joe York, President -FL
 Jacksonville, Florida

ACCESS SERVICES TARIFF

Fourth Revised Page 48.4.1
 Cancels Third Revised Page 48.4.1

EFFECTIVE: August 22, 2021

E7. SPECIAL ACCESS (A.K.A. BELLSOUTH SPA) SERVICE

E7.4 Rate Regulations (Cont'd)

E7.4.32 BellSouth Metro Ethernet Service (Cont'd)³

(C)

B. Rate Categories and Regulations (Cont'd)

5. The following informational chart provides the physical service type of each BellSouth Metro Ethernet Connection and provides the other BellSouth Metro Ethernet Connections which are considered to be a higher order of service (BellSouth Metro Ethernet service hierarchy).

Metro Ethernet Connection (Mbps):	Physical Service Type:	Higher Order of Service (Mbps):
- Basic 2	Basic 0	Basic 4,8,10,100,1000; Premium ¹ 2, 4, 8,10,20,50,100,250,500; Virtual 2,4,8,10,20,50,80,100,200,300,450,600,750,900
- Basic 4	Basic 0	Basic 8,10,100,1000; Premium ¹ 4, 8,10,20,50,100,250,500; Virtual 4,8,10,20,50,80,100,200,300,450,600,750,900
- Basic 8	Basic 0	Basic 10,100,1000; Premium ¹ 8,10,20,50,100,250,500; Virtual 8,10,20,50,80,100,200,300,450,600,750, 900
- Basic 10	Basic I	Basic 100,1000; Premium ¹ 10,20,50,100,250,500,900 ² ; Virtual 10,20,50,80,100, 200,300,450,600,750,900
- Basic 100	Basic II	Basic 1000; Premium ¹ 100,250,500,900 ² ; Virtual 80, 100,200,300,450,600,750,900
- Basic 1000	Basic III	Premium ¹ 500,900 ² ; Virtual 450,600,750,900
- Premium 2	Premium 0	Basic 100,1000; Premium ¹ 4,8,10,20,50,100,250,500; Virtual 2,4,8,10,20,50,80,100,200,300,450,600,750,900
- Premium 4	Premium 0	Basic 100,1000; Premium ¹ 8,10,20,50,100,250,500; Virtual 4,8,10,20,50,80,100,200,300,450,600,750,900
- Premium 8	Premium 0	Basic 100,1000; Premium ¹ 10,20,50,100,250,500; Virtual 8,10,20,50,80,100,200,300,450,600,750,900
- Premium ¹ 10	Premium I	Basic 1000; Premium ¹ 20,50,100,250,500,900 ² ; Virtual 10,20,50,80,100,200,300, 450,600,750,900
- Premium ¹ 20	Premium I	Basic 1000; Premium ¹ 50,100,250,500,900 ² ; Virtual 20,50,80,100,200,300,450, 600,750,900
- Premium ¹ 50	Premium I	Premium ¹ 100,250,500,900 ² ; Virtual 50,80,100,200, 300,450,600,750,900
- Premium ¹ 100	Premium II	Premium ¹ 250,500,900 ² ; Virtual 100,200,300,450,600,750,900
- Premium ¹ 250	Premium II	Premium ¹ 500,900 ² ; Virtual 300,450,600,750,900
- Premium ¹ 500	Premium II	Premium 900 ² ; Virtual 450,600,750,900
- Premium 900 ²	Premium II	Virtual 900
- Virtual 2	Virtual 0	Basic 100,1000; Premium ¹ 10,20,50,100,250,500; Virtual 4,8,10,20,50,80,100,200,300,450,600,750,900
- Virtual 4	Virtual 0	Basic 100,1000; Premium ¹ 10,20,50,100,250,500; Virtual 8,10,20,50,80,100,200,300,450,600,750,900
- Virtual 8	Virtual 0	Basic 100,1000; Premium ¹ 10,20,50,100,250,500; Virtual 10,20,50,80,100,200,300,450,600,750,900
- Virtual 10	Virtual I	Basic 1000; Premium ¹ 20,50,100,250,500,900 ² ; Virtual 20,50,80,100,200,300,450, 600, 750,900
- Virtual 20	Virtual I	Basic 1000; Premium ¹ 50,100,250,500,900 ² ; Virtual 50,80,100,200,300,450,600,750,900
- Virtual 50	Virtual II	Basic 1000; Premium ¹ 100,250,500,900 ² ; Virtual 80, 100,200,300,450,600,750,900
- Virtual 80	Virtual II	Basic 1000; Premium ¹ 100,250,500,900 ² ; Virtual 100, 200,300,450,600,750,900
- Virtual 100	Virtual II	Premium ¹ 250,500,900 ² ; Virtual 200,300,450,600,750,900
- Virtual 200	Virtual II	Premium ¹ 500,900 ² ; Virtual 300,450,600,750,900
- Virtual 300	Virtual II	Premium ¹ 500,900 ² ; Virtual 450,600,750,900
- Virtual 450	Virtual II	Premium 900 ² ; Virtual 600,750,900
- Virtual 600	Virtual II	Premium 900 ² ; Virtual 750,900
- Virtual 750	Virtual II	Premium 900 ² ; Virtual 900
- Virtual 900	Virtual II	None offered at this time

Note in the above chart that the reference to Basic 1000 Mbps refers to Basic I Gbps.

Note 1: Fixed Mode or Burst Mode.

Note 2: Premium 900 Mbps only available as Fixed Mode.

Note 3: Effective on or after August 22, 2021, this Service will no longer be available for purchase by new or existing customers. In addition, requests to move, add, change, or renew existing service arrangements will not be accepted. Following the expiration of a customer's existing term agreement, service will be provided on a month-to-month basis at the applicable Monthly rates until the service is discontinued. The Company currently plans to discontinue this service on or after March 31, 2023.

(N)

(N)

BELLSOUTH
TELECOMMUNICATIONS
FLORIDA

ACCESS SERVICES TARIFF

Second Revised Page 48.4.2
Cancels First Revised Page 48.4.2

ISSUED: August 20, 2021
BY: Joe York, President -FL
Jacksonville, Florida

EFFECTIVE: August 22, 2021

E7. SPECIAL ACCESS (A.K.A. BELLSOUTH SPA) SERVICE

E7.4 Rate Regulations (Cont'd)

E7.4.32 BellSouth Metro Ethernet Service (Cont'd)¹

(C)

B. Rate Categories and Regulations (Cont'd)

6. A BellSouth Metro Ethernet reconfiguration nonrecurring charge is applicable for a customer request to reconfigure (rearrange) an existing BellSouth Metro Ethernet Connection. The appropriate reconfiguration charge is dependent upon the physical work required to fulfill the request and applies in lieu of other nonrecurring charges.

A Service Reconfiguration Charge is applicable for requests where the work required is a minor change that does not involve changing the physical service type. The Service Reconfiguration Charge is applicable for a request to change an existing connection to a different connection that is the same physical service type *that is a lower order of service*, is applicable for a request to change a Premium connection from fixed mode to burst mode (and vice versa) and is applicable for a request to change a Premium connection to add or delete the Priority Plus feature. The Service Reconfiguration Charge is also applicable for changing an existing Virtual connection CoS Profile.

A System Reconfiguration Charge is applicable for requests where the work required involves changing to a different physical service type or involves major support system changes. The System Reconfiguration Charge is applicable for requests to change an existing connection to a different connection that is a different physical service type *that is a lower order of service*, to change the network channel terminating equipment (NCTE) interface option from optical to electrical (or vice-versa), and to change the premises powering options from AC power to DC power (or vice-versa).
7. **(DELETED)**

Note 1: Effective on or after August 22, 2021, this Service will no longer be available for purchase by new or existing customers. In addition, requests to move, add, change, or renew existing service arrangements will not be accepted. Following the expiration of a customer's existing term agreement, service will be provided on a month-to-month basis at the applicable Monthly rates until the service is discontinued. The Company currently plans to discontinue this service on or after March 31, 2023.

(N)

(N)

BELLSOUTH
TELECOMMUNICATIONS
FLORIDA

ACCESS SERVICES TARIFF

Third Revised Page 48.5
Cancels Second Revised Page 48.5

ISSUED: August 20, 2021
BY: Joe York, President -FL
Jacksonville, Florida

EFFECTIVE: August 22, 2021

E7. SPECIAL ACCESS (A.K.A. BELLSOUTH SPA) SERVICE

E7.4 Rate Regulations (Cont'd)

E7.4.32 BellSouth Metro Ethernet Service (Cont'd)²

(C)

B. Rate Categories and Regulations (Cont'd)

8. A Premium BellSouth Metro Ethernet Connection-Fixed Mode and Premium BellSouth Metro Ethernet Connection-Burst Mode of the same speed are considered to be the same order of service and same physical service type. A Service Reconfiguration Charge is applicable for a customer request to reconfigure a Premium BellSouth Metro Ethernet Connection from Fixed Mode to Burst Mode (at the same speed), or vice versa; this nonrecurring charge is in lieu of the nonrecurring charge for the new connection. Such a change is not treated as a disconnect and there will be no change in the minimum period requirements.

A Virtual BellSouth Metro Ethernet Connection request to modify its CoS Profile is not considered as a request to change the order of service or physical service type. A Service Reconfiguration Charge is applicable for such requests.
9. Except as specified in 8. preceding, a BellSouth Metro Ethernet Connection not shown as a higher order of service in the hierarchy chart in 5. preceding for a given BellSouth Metro Ethernet Connection is considered to be a lower order of service. A reconfiguration charge is applicable for a customer request to change an existing BellSouth Metro Ethernet Connection to a different BellSouth Metro Ethernet Connection that is a lower order of service; the appropriate reconfiguration charge is applicable in lieu of the standard nonrecurring charge for the lower order of service connection. A Service Reconfiguration Charge is applicable when the lower order of service connection is the same physical service type; a System Reconfiguration Charge is applicable when the lower order of service is a different physical service type. New minimum period requirements are established for the lower order of service connection.
10. A System Reconfiguration Charge is applicable for a customer request to change the premises powering option (AC power to DC power) or NCTE signaling interface option (optical to electrical, or vice-versa) on an existing BellSouth Metro Ethernet Connection. Such a change is not treated as a disconnect and there will be no change in the minimum period requirements.
11. A move of a BellSouth Metro Ethernet service will be as follows (in accordance with E7.4.5 preceding and, if applicable, E2.4.9.C.5. of this Tariff).

When the move is to a new location within the same building, the charge for the move will be an amount equal to one-half of the Connection nonrecurring charge. There will be no change in the minimum period requirements.

When the move is to a new location in a different building that is within the same serving wire center, the charge for the move will be the nonrecurring charge for the BellSouth Metro Ethernet service Connection. New minimum period requirements will be established.¹

When the move is to a new location in a different building that is not in the same serving wire center, the request is treated as a discontinuance and start of service and all associated BellSouth Metro Ethernet service nonrecurring charges will apply. New minimum period requirements will be established.¹

Note 1: Such moves of Metro Ethernet Service with Automatic Protection Switching (APS) shall additionally incur the full nonrecurring charge for establishing the APS feature at the new premises (as a new APS design will be required). The APS monthly recurring charge may change as appropriate based upon the actual route mileage associated with the new premises' APS design.

Note 2: Effective on or after August 22, 2021, this Service will no longer be available for purchase by new or existing customers. In addition, requests to move, add, change, or renew existing service arrangements will not be accepted. Following the expiration of a customer's existing term agreement, service will be provided on a month-to-month basis at the applicable Monthly rates until the service is discontinued. The Company currently plans to discontinue this service on or after March 31, 2023.

(N)
|
(N)

E7. SPECIAL ACCESS (A.K.A. BELLSOUTH SPA) SERVICE**E7.4 Rate Regulations (Cont'd)****E7.4.32 BellSouth Metro Ethernet Service (Cont'd)²**

(C)

C. Service Level Agreement for Premium BellSouth Metro Ethernet service

Customer networks with Premium BellSouth Metro Ethernet service and *CNM* - Metro Ethernet Reporting are provided Service Level Agreements (SLAs) as summarized herein E7.4.32.C. BellSouth Metro Ethernet Service SLAs outlined herein specify the Company's repair and performance commitments for *CNM* - Metro Ethernet Reporting customers with Premium Metro Ethernet Connections. Details of the technical measurements and performance results methodologies for each commitment are provided in BellSouth Technical Reference TR-73632.

In accordance with E7.4.32.C.3.(c) following, credits are available for missed commitments to customers purchasing Premium BellSouth Metro Ethernet service with the *CNM* - Metro Ethernet Reporting feature. Credits only apply for portions of service provided by the Company.

The following service measurements will outline the service levels the Telephone Company will deliver to *CNM* - Metro Ethernet Reporting customers with Premium Metro Ethernet Connections:

Repair Commitment:

- BellSouth Metro Ethernet service Time-to-Repair¹

Network Service Level Commitments:

- BellSouth Metro Ethernet service Core Network Availability
- BellSouth Metro Ethernet service Core Network Latency

The Repair Commitment is measured on a per occurrence basis for each BellSouth Metro Ethernet Connection. A Fault Report is produced thru the *CNM* - Metro Ethernet Reporting system that aids identification of potential outage durations upon which credits may be requested.

The Network Service Level Commitments are measured on the monthly performance of the Metro Ethernet core network during a specific calendar month. An SLA Report is produced thru the *CNM* - Metro Ethernet Reporting system that provides details of missed Network Service Level Commitments upon which credits may be requested based upon a specific calendar month's performance results.

The Company's performance measurement data for the Repair Commitment and Network Service Level Commitments will be collected and calculated utilizing the Company's internal processes as set forth in BellSouth Technical Reference TR-73632. The Company's calculation of its performance shall be the sole determinate of the Company's obligation to provide a credit for a missed performance commitment.

1. SLA Definitions**BellSouth Metro Ethernet service Time to Repair**

- BellSouth Metro Ethernet service Time-To-Repair measures the outage duration on a customer's BellSouth Metro Ethernet Connection. This measure will require the customer to report the problem to the BellSouth repair center.
- The repair interval will start with the time the trouble ticket is created and end when the fault is re-mediated. The Service Level Commitment measurement will be based on each individual trouble ticket for a customer's connection. Time for scheduled maintenance windows (as set forth in E7.4.32.A.3. preceding) does not count towards SLA threshold.

BellSouth Metro Ethernet service Network Availability

- BellSouth Metro Ethernet service Network Availability measures the percentage of time during a calendar month that the customer's service is unavailable on the core network. The core network is defined as being from the Ethernet switch serving the customer's A-end to the Ethernet switch serving the customer's B-end. Customer networks that do not span more than one switch in the core network are not eligible for the Network Availability SLA, and one will not be provided.
- This Service Level Commitment will be calculated by measuring and summing the outage for each core network component used by the customer, divided by the total number of components, times the total service time for a particular calendar month. Excluded from the outage time and service time are scheduled maintenance windows (as set forth in E7.4.32.A.3. preceding) and time the network was unavailable due to circumstances outside the Company's control (as set forth in E7.4.32.C.3.(b) following).

Note 1: SLA not applicable if missed due to SMARTRing service (a.k.a BellSouth SPA Dedicated Ring) outage where BellSouth Metro Ethernet is using SMARTRing service (a.k.a BellSouth SPA Dedicated Ring) as alternate transport.

Note 2: Effective on or after August 22, 2021, this Service will no longer be available for purchase by new or existing customers. In addition, requests to move, add, change, or renew existing service arrangements will not be accepted. Following the expiration of a customer's existing term agreement, service will be provided on a month-to-month basis at the applicable Monthly rates until the service is discontinued. The Company currently plans to discontinue this service on or after March 31, 2023.

(N)

(N)

E7. SPECIAL ACCESS (A.K.A. BELLSOUTH SPA) SERVICE**E7.4 Rate Regulations (Cont'd)****E7.4.32 BellSouth Metro Ethernet Service (Cont'd)²**

(C)

C. Service Level Agreement for Premium BellSouth Metro Ethernet service¹ (Cont'd)**1. SLA Definitions (Cont'd)**

BellSouth Metro Ethernet service Network Latency

- BellSouth Metro Ethernet service Network Latency measures average one-way delay in milliseconds within the core network. The core network is defined as being from the Ethernet switch serving the customer's A-end to the Ethernet switch serving the customer's B-end. Customer networks that do not span more than one switch in the core network are not eligible for the Network Latency SLA, and one will not be provided.
- This Service Level Commitment will be calculated by averaging the measured latency of simulated traffic within the Metro Ethernet Customer Network (i.e., between each pair of connections) during a calendar month.

2. The Company's Service Level Commitments for Premium BellSouth Metro Ethernet service are as follows:

- BellSouth Metro Ethernet service Time-To-Repair – 4 hours or less
- BellSouth Metro Ethernet service Network Availability – 99.9% or higher
- BellSouth Metro Ethernet service Network Latency – 55 milliseconds or less

3. SLA Restrictions

- (a) The Company will implement SLA provisioning restrictions that will define customer network design requirements and limitations to BellSouth's commitment to meet Service Levels for BellSouth Metro Ethernet service. The customer network design requirements are as follows:
 - A customer must subscribe to the Metro Ethernet Premium Service with *CNM* - Metro Ethernet Reporting to receive credits for missed Service Level Commitments.
 - Credits are not provided for partial month service.
 - A customer's account must be current to receive a credit.
- (b) SLA Credits do not apply when any stated objective is not met because the Company does not have control over the circumstances causing the objective to be missed. Situations over which the Company does not have control include, but are not limited to, the following:
 - any act, any omission or negligence on the part of the customer, any other customer or any third party, or of any other entity providing a portion of the service,
 - labor difficulties, governmental orders, civil commotions, acts of civil or military authority, embargoes, epidemics, declared National Emergencies, criminal actions against the Company, war, terrorist acts, riots, insurrections, fires, explosions, nuclear accidents, power blackouts, acts of God (including, but not limited to, earthquakes, floods or unusually severe weather) or other circumstances beyond the Company's control,
 - the customer's premises equipment, and
 - unavailability of the customer's facilities and/or equipment including customer-provided power and environmental conditions for BellSouth-owned and operated equipment located on the customer's premises.
- (c) The Customer must request a credit within one month of the Company missing a BellSouth Metro Ethernet service Level Commitment. A customer request for a Network Service Level SLA credit must be submitted on a standard request form issued by the Company that includes the month the SLA commitment was missed, accurate identification of the affected circuit, and the observed measurement of the specific SLA that was missed. A customer request for a Repair SLA credit must be submitted on a standard request form issued by the Company that includes the month the SLA commitment was missed, accurate identification of the affected circuit, and the trouble ticket number of the repair request. The Company will investigate customer requests for any SLA credits to determine the cause of any performance failures reported by the customer. The Company will investigate the customer's request over a period of up to 45 calendar days. The 45-day period will begin when the customer makes the request for credit with their BellSouth Sales Representative. SLA credits will be provided to the customer if the Company determines that the Company had control over the circumstances causing the failure.

Note 1: Details of the technical measurements and performance results methodologies for each Commitment are provided in BellSouth Technical Reference TR-73632.

Note 2: Effective on or after August 22, 2021, this Service will no longer be available for purchase by new or existing customers. In addition, requests to move, add, change, or renew existing service arrangements will not be accepted. Following the expiration of a customer's existing term agreement, service will be provided on a month-to-month basis at the applicable Monthly rates until the service is discontinued. The Company currently plans to discontinue this service on or after March 31, 2023.

(N)

(N)

BELLSOUTH
TELECOMMUNICATIONS
FLORIDA

ACCESS SERVICES TARIFF

Third Revised Page 48.8
Cancels Second Revised Page 48.8

ISSUED: August 20, 2021
BY: Joe York, President -FL
Jacksonville, Florida

EFFECTIVE: August 22, 2021

E7. SPECIAL ACCESS (A.K.A. BELLSOUTH SPA) SERVICE

E7.4 Rate Regulations (Cont'd)

E7.4.32 BellSouth Metro Ethernet Service (Cont'd)⁴

(C)

C. Service Level Agreement for Premium BellSouth Metro Ethernet service¹ (Cont'd)

4. SLA Credits for Premium Connections with *CNM* - Metro Ethernet Reporting

The following credits will apply when the Company misses a Service Level Commitment (each credit is described in (a) thru (c) following):

BellSouth Metro Ethernet service Time-To-Repair:

- 0 to 4 hours per incident: No Credit
- Over 4 hours to 24 hours per incident: A credit equal to 3/30 of the monthly recurring charges for all the rate elements² associated with the affected Metro Ethernet Connection
- Each additional 24-hour period, per incident: Credit an additional amount equal to 3/30 of the monthly recurring charges for all the rate elements² associated with the affected Metro Ethernet Connection

BellSouth Metro Ethernet service Network Availability:

- A credit equal to 3/30 of the monthly recurring charges for all the rate elements² associated with the affected Metro Ethernet Connection.

BellSouth Metro Ethernet service Network Latency:

- A credit equal to 3/30 of the monthly recurring charges for all the rate elements² associated with the affected Metro Ethernet Connection.

The SLA credit amount will be determined by applying the credits outlined preceding to the rate elements or total billed revenues specified following.

The total credits issued for all SLAs for a specific BellSouth Metro Ethernet service Connection during a single bill period may not exceed the total monthly recurring charges billed for all the rate elements associated with that BellSouth Metro Ethernet service Connection. Credits are not provided for partial month service.

- (a) BellSouth Metro Ethernet service Time-To-Repair Credit – The Service Level Commitment measurement will be based on each individual trouble ticket for a customer's connection. Multiple trouble tickets on the same day for the same customer connection will only be eligible for one time-to-repair credit. The SLA credit will apply to the monthly recurring charges for all the rate elements² associated with the affected Metro Ethernet Connection.
- (b) BellSouth Metro Ethernet service Network Availability Credit³ – The Service Level commitment measurement will be based on a specific calendar month's performance. The credit will apply for each BellSouth Metro Ethernet service connection that does not meet the availability commitment. The SLA credit will apply to the monthly recurring charges for all the rate elements² associated with the affected Metro Ethernet Connection.
- (c) BellSouth Metro Ethernet service Latency Credit³ – The Service Level commitment measurement will be based on a specific calendar month's performance. The credit will apply for each BellSouth Metro Ethernet service connection that does not meet the latency commitment. The SLA credit will apply to the monthly recurring charges for all the rate elements² associated with the affected Metro Ethernet Connection.

Note 1: Details of the technical measurements and performance results methodologies for each Commitment are provided in BellSouth Technical Reference TR-73632.

Note 2: Specifically, rate elements for the Metro Ethernet Connection, Additional Mileage and Features.

Note 3: BellSouth Metro Ethernet networks that do not span more than one switch in the core network are not eligible for credits under this SLA.

Note 4: Effective on or after August 22, 2021, this Service will no longer be available for purchase by new or existing customers. In addition, requests to move, add, change, or renew existing service arrangements will not be accepted. Following the expiration of a customer's existing term agreement, service will be provided on a month-to-month basis at the applicable Monthly rates until the service is discontinued. The Company currently plans to discontinue this service on or after March 31, 2023.

(N)

(N)

BELLSOUTH
TELECOMMUNICATIONS
FLORIDA

ACCESS SERVICES TARIFF

Third Revised Page 48.9
Cancels Second Revised Page 48.9

ISSUED: August 20, 2021
BY: Joe York, President -FL
Jacksonville, Florida

EFFECTIVE: August 22, 2021

E7. SPECIAL ACCESS (A.K.A. BELLSOUTH SPA) SERVICE

E7.4 Rate Regulations (Cont'd)

E7.4.32 BellSouth Metro Ethernet Service (Cont'd)⁴

(C)

D. Service Level Agreement for Virtual BellSouth Metro Ethernet service

Customer networks with Virtual BellSouth Metro Ethernet Service and *CNM* - Metro Ethernet Reporting are provided Service Level Agreements (SLAs) as summarized herein E7.4.32.D. BellSouth Metro Ethernet Service SLAs outlined herein specify the Telephone Company's repair and performance commitments for *CNM* - Metro Ethernet Reporting customers with Virtual Metro Ethernet Connections. SLAs will be applied on a per Class of Service (CoS) basis for Virtual Connections; traffic representing the different CoS (i.e., Best Effort, Business Critical, Real-Time and Interactive) transported across the same Virtual Connection will have different SLAs. Details of the technical measurements and performance results methodologies for each commitment are provided in BellSouth Technical Reference TR-73632.

In accordance with E7.4.32.D.3.(c) following, credits are available for missed commitments to customers purchasing Virtual BellSouth Metro Ethernet Service with the Metro Ethernet Reporting feature. Credits only apply for portions of service provided by the Telephone Company.

The following service measurements will outline the service levels the Telephone Company will deliver to *CNM* - Metro Ethernet Reporting customers with Virtual Metro Ethernet Connections:

Repair Commitment:

- BellSouth Metro Ethernet service Time-to-Repair¹

Network Service Level Commitments:

- BellSouth Metro Ethernet service Core Network Availability
- BellSouth Metro Ethernet service Core Network Latency²
- BellSouth Metro Ethernet service Core Network Jitter^{2,3}
- BellSouth Metro Ethernet service Core Network Packet Delivery²

The Repair Commitment is measured on a per occurrence basis for each BellSouth Metro Ethernet Connection for all CoS. A Fault Report is produced thru the *CNM* - Metro Ethernet Reporting system that aids identification of potential outage durations upon which credits may be requested.

The Network Service Level Commitments are measured on the monthly performance of the Metro Ethernet core network during a specific calendar month by CoS. An SLA Report is produced thru the *CNM* - Metro Ethernet Reporting system that provides details of missed Network Service Level Commitments by CoS upon which credits may be requested based upon a specific calendar month's performance results.

The Company's performance measurement data for the Repair Commitment and Network Service Level Commitments will be collected and calculated utilizing the Company's internal processes as set forth in BellSouth Technical Reference TR-73632. The Company's calculation of its performance shall be the sole determinate of the Company's obligation to provide a credit for a missed performance commitment.

Note 1: SLA not applicable if missed due to SMARTRing service (a.k.a BellSouth SPA Dedicated Ring) outage where BellSouth Metro Ethernet is using SMARTRing service (a.k.a BellSouth SPA Dedicated Ring) as alternate transport.

Note 2: SLA not applicable for Best Effort CoS.

Note 3: SLA not applicable for Business Critical CoS.

Note 4: Effective on or after August 22, 2021, this Service will no longer be available for purchase by new or existing customers. In addition, requests to move, add, change, or renew existing service arrangements will not be accepted. Following the expiration of a customer's existing term agreement, service will be provided on a month-to-month basis at the applicable Monthly rates until the service is discontinued. The Company currently plans to discontinue this service on or after March 31, 2023.

(N)

(N)

BELLSOUTH
TELECOMMUNICATIONS
FLORIDA

ACCESS SERVICES TARIFF

First Revised Page 48.10
Cancels Original Page 48.10

ISSUED: August 20, 2021
BY: Joe York, President -FL
Jacksonville, Florida

EFFECTIVE: August 22, 2021

E7. SPECIAL ACCESS (A.K.A. BELLSOUTH SPA) SERVICE

E7.4 Rate Regulations (Cont'd)

E7.4.32 BellSouth Metro Ethernet Service (Cont'd)²

(C)

D. Service Level Agreement for Virtual BellSouth Metro Ethernet service¹ (Cont'd)

1. SLA Definitions

BellSouth Metro Ethernet service Time to Repair

- BellSouth Metro Ethernet Service Time-To-Repair measures the outage duration on a customer's BellSouth Metro Ethernet Connection for all CoS. This measure will require the customer to report the problem to the BellSouth repair center.
- The repair interval will start with the time the trouble ticket is created and end when the fault is re-mediated. The Service Level Commitment measurement will be based on each individual trouble ticket for a customer's connection. Time for scheduled maintenance windows (as set forth in E7.4.32.A.3.) does not count towards SLA threshold.

BellSouth Metro Ethernet service Network Availability

- BellSouth Metro Ethernet Service Network Availability measures the percentage of time by CoS during a calendar month that the customer's service is unavailable on the core network. The core network is defined as being from the Ethernet switch serving the customer's A-end to the Ethernet switch serving the customer's B-end. Customer networks that do not span more than one switch in the core network are not eligible for the Network Availability SLA, and one will not be provided.
- This Service Level Commitment will be calculated by CoS by measuring and summing the outage for each core network component used by the customer, divided by the total number of components, times the total service time for a particular calendar month. Excluded from the outage time and service time are scheduled maintenance windows (as set forth in E7.4.32.A.3.) and time the network was unavailable due to circumstances outside the Telephone Company's control (as set forth in E7.4.32.D.3.(b)).

BellSouth Metro Ethernet service Network Latency

- BellSouth Metro Ethernet Service Network Latency measures average one-way delay in milliseconds within the core network. The core network is defined as being from the Ethernet switch serving the customer's A-end to the Ethernet switch serving the customer's B-end. Customer networks that do not span more than one switch in the core network are not eligible for the Network Latency SLA, and one will not be provided.
- This Service Level Commitment will be calculated for each CoS (except the Best Effort CoS) by averaging the measured latency of simulated traffic for each eligible CoS within the Metro Ethernet Customer Network (i.e., between each pair of connections) during a calendar month.

BellSouth Metro Ethernet service Network Jitter

- BellSouth Metro Ethernet Service Jitter measures the average variability, measured in time (milliseconds) between the actual packet transmission rate and the expected packet transmission rate within the core network for Interactive and Real-Time CoS. The core network is defined as being from the Ethernet switch serving the customer's A-end to the Ethernet switch serving the customer's B-end.
- This Service Level Commitment will be calculated for the Interactive CoS and Real-Time CoS by averaging the measured jitter of simulated traffic for each of the customer's eligible CoS queue within the Metro Ethernet Customer Network (i.e., between each pair of connections) during a calendar month.

BellSouth Metro Ethernet service Packet Delivery

- BellSouth Metro Ethernet Service Network Packet Delivery measures the percentage of packets conforming to the committed bandwidth profile that are delivered across the core network, without being dropped or lost as a result of a fault within the Virtual Ethernet network. The core network is defined as being from the Ethernet switch serving the customer's A-end to the Ethernet switch serving the customer's B-end.
- This Service Level Commitment will be calculated for each CoS (except the Best Effort CoS) by averaging the measured packet delivery of simulated traffic for eligible CoS within the Metro Ethernet Customer Network (i.e., between each pair of connections) during a calendar month.

Note 1: Details of the technical measurements and performance results methodologies for each commitment are provided in BellSouth Technical Reference TR-73632.

Note 2: Effective on or after August 22, 2021, this Service will no longer be available for purchase by new or existing customers. In addition, requests to move, add, change, or renew existing service arrangements will not be accepted. Following the expiration of a customer's existing term agreement, service will be provided on a month-to-month basis at the applicable Monthly rates until the service is discontinued. The Company currently plans to discontinue this service on or after March 31, 2023.

(N)
|
(N)

BELLSOUTH
TELECOMMUNICATIONS
FLORIDA

ACCESS SERVICES TARIFF

First Revised Page 48.11
Cancels Original Page 48.11

ISSUED: August 20, 2021
BY: Joe York, President -FL
Jacksonville, Florida

EFFECTIVE: August 22, 2021

E7. SPECIAL ACCESS (A.K.A. BELLSOUTH SPA) SERVICE

E7.4 Rate Regulations (Cont'd)

E7.4.32 BellSouth Metro Ethernet Service (Cont'd)²

(C)

D. Service Level Agreement for Virtual BellSouth Metro Ethernet service¹ (Cont'd)

2. The Telephone Company's Service Level Commitments for Virtual BellSouth Metro Ethernet service are as follows:

Time to Repair

- Best Effort CoS: 4 hours or less
- Business Critical CoS: 4 hours or less
- Interactive CoS: 4 hours or less
- Real-Time CoS: 4 hours or less

Network Availability

- Best Effort CoS: 99.500% or greater
- Business Critical CoS: 99.995% or greater
- Interactive CoS: 99.995% or greater
- Real-Time CoS: 99.995% or greater

Latency (one-way)

- Best Effort CoS: Not Applicable
- Business Critical CoS: 15 milliseconds or less
- Interactive CoS: 5 milliseconds or less
- Real-Time CoS: 5 milliseconds or less

Jitter

- Best Effort CoS: Not Applicable
- Business Critical CoS: Not Applicable
- Interactive CoS: 1 millisecond or less
- Real-Time CoS: 1 millisecond or less

Packet Delivery

- Best Effort CoS: Not Applicable
- Business Critical CoS: 99.900% or greater
- Interactive CoS: 99.950% or greater
- Real-Time CoS: 99.995% or greater

Note 1: Details of the technical measurements and performance results methodologies for each commitment are provided in BellSouth Technical Reference TR-73632.

Note 2: Effective on or after August 22, 2021, this Service will no longer be available for purchase by new or existing customers. In addition, requests to move, add, change, or renew existing service arrangements will not be accepted. Following the expiration of a customer's existing term agreement, service will be provided on a month-to-month basis at the applicable Monthly rates until the service is discontinued. The Company currently plans to discontinue this service on or after March 31, 2023.

(N)

(N)

BELLSOUTH
TELECOMMUNICATIONS
FLORIDA

ACCESS SERVICES TARIFF

Second Revised Page 48.12
Cancels First Revised Page 48.12

ISSUED: August 20, 2021
BY: Joe York, President -FL
Jacksonville, Florida

EFFECTIVE: August 22, 2021

E7. SPECIAL ACCESS (A.K.A. BELLSOUTH SPA) SERVICE

E7.4 Rate Regulations (Cont'd)

E7.4.32 BellSouth Metro Ethernet Service (Cont'd)²

(C)

D. Service Level Agreement for Virtual BellSouth Metro Ethernet service¹ (Cont'd)

3. SLA Restrictions

- (a) The Telephone Company will implement SLA provisioning restrictions that will define customer network design requirements and limitations to BellSouth's commitment to meet Service Levels for BellSouth Metro Ethernet Service. The customer network design requirements are as follows:
- A customer must subscribe to the Metro Ethernet Virtual Service with *CNM* - Metro Ethernet Reporting to receive credits for missed Service Level Commitments.
 - Credits are not provided for partial month service.
 - A customer's account must be current to receive a credit.
- (b) SLA Credits do not apply when any stated objective is not met because the Telephone Company does not have control over the circumstances causing the objective to be missed. Situations over which the Telephone Company does not have control include, but are not limited to, the following:
- any act, any omission or negligence on the part of the customer, any other customer or any third party, or of any other entity providing a portion of the service,
 - labor difficulties, governmental orders, civil commotions, acts of civil or military authority, embargoes, epidemics, declared National Emergencies, criminal actions against the Telephone Company, war, terrorist acts, riots, insurrections, fires, explosions, nuclear accidents, power blackouts, acts of God (including, but not limited to, earthquakes, floods or unusually severe weather) or other circumstances beyond the Telephone Company's control,
 - the customer's premises equipment, and
 - unavailability of the customer's facilities and/or equipment including customer-provided power and environmental conditions for BellSouth-owned and operated equipment located on the customer's premises.
- (c) The Customer must request a credit within one month of the Telephone Company missing a BellSouth Metro Ethernet Service Level Commitment. A customer request for a Network Service Level SLA credit must be submitted on a standard request form issued by the Company that includes the month the SLA commitment was missed, accurate identification of the affected circuit, and the observed measurement of the specific SLA that was missed. A customer request for a Repair SLA credit must be submitted on a standard request form issued by the Company that includes the month the SLA commitment was missed, accurate identification of the affected circuit, and the trouble ticket number of the repair request. The Telephone Company will investigate customer requests for any SLA credits to determine the cause of any performance failures reported by the customer. The Telephone Company will investigate the customer's request over a period of up to 45 calendar days. The 45-day period will begin when the customer makes the request for credit with their BellSouth Sales Representative. SLA credits will be provided to the customer if the Company determines that the Telephone Company had control over the circumstances causing the failure.

Note 1: Details of the technical measurements and performance results methodologies for each commitment are provided in BellSouth Technical Reference TR-73632.

Note 2: Effective on or after August 22, 2021, this Service will no longer be available for purchase by new or existing customers. In addition, requests to move, add, change, or renew existing service arrangements will not be accepted. Following the expiration of a customer's existing term agreement, service will be provided on a month-to-month basis at the applicable Monthly rates until the service is discontinued. The Company currently plans to discontinue this service on or after March 31, 2023.

(N)
|
(N)

BELLSOUTH
TELECOMMUNICATIONS
FLORIDA

ACCESS SERVICES TARIFF

Second Revised Page 48.13
Cancels First Revised Page 48.13

ISSUED: August 20, 2021
BY: Joe York, President -FL
Jacksonville, Florida

EFFECTIVE: August 22, 2021

E7. SPECIAL ACCESS (A.K.A. BELLSOUTH SPA) SERVICE

E7.4 Rate Regulations (Cont'd)

E7.4.32 BellSouth Metro Ethernet Service (Cont'd)³

(C)

D. Service Level Agreement for Virtual BellSouth Metro Ethernet service¹ (Cont'd)

4. SLA Credits for Virtual Connections with *CNM* - Metro Ethernet Reporting (Cont'd)

The following credits will apply when the Telephone Company misses a Service Level Commitment on any single CoS (each credit is described in (a) thru (e) following). A maximum of one credit will be applied monthly per Connection for an SLA not met for any CoS that is supported by the customer's CoS profile (i.e., a maximum of one credit is applicable for an SLA even if missed for multiple CoS).

BellSouth Metro Ethernet service Time-To-Repair:

- 0 to 4 hours per incident: No Credit
- Over 4 hours to 24 hours per incident: A credit equal to 3/30 of the monthly recurring charges for all the rate elements² associated with the affected Metro Ethernet Connection
- Each additional 24-hour period, per incident: Credit an additional amount equal to 3/30 of the monthly recurring charges for all the rate elements² associated with the affected Metro Ethernet Connection

BellSouth Metro Ethernet service Network Availability: A credit equal to 3/30 of the monthly recurring charges for all the rate elements² associated with the affected Metro Ethernet Connection

BellSouth Metro Ethernet service Latency: A credit equal to 3/30 of the monthly recurring charges for all the rate elements² associated with the affected Metro Ethernet Connection.

BellSouth Metro Ethernet service Jitter: A credit equal to 3/30 of the monthly recurring charges for all the rate elements² associated with the affected Metro Ethernet Connection.

BellSouth Metro Ethernet service Packet Delivery: A credit equal to 3/30 of the monthly recurring charges for all the rate elements² associated with the affected Metro Ethernet Connection.

Note 1: Details of the technical measurements and performance results methodologies for each commitment are provided in BellSouth Technical Reference TR-73632.

Note 2: Specifically, rate elements for the Metro Ethernet Connection, Additional Mileage and Features.

Note 3: Effective on or after August 22, 2021, this Service will no longer be available for purchase by new or existing customers. In addition, requests to move, add, change, or renew existing service arrangements will not be accepted. Following the expiration of a customer's existing term agreement, service will be provided on a month-to-month basis at the applicable Monthly rates until the service is discontinued. The Company currently plans to discontinue this service on or after March 31, 2023.

(N)

(N)

BELLSOUTH
TELECOMMUNICATIONS
FLORIDA

ACCESS SERVICES TARIFF

Second Revised Page 48.14
Cancels First Revised Page 48.14

ISSUED: August 20, 2021
BY: Joe York, President -FL
Jacksonville, Florida

EFFECTIVE: August 22, 2021

E7. SPECIAL ACCESS (A.K.A. BELLSOUTH SPA) SERVICE

E7.4 Rate Regulations (Cont'd)

E7.4.32 BellSouth Metro Ethernet Service (Cont'd)⁴

(C)

D. Service Level Agreement for Virtual BellSouth Metro Ethernet service¹ (Cont'd)

4. SLA Credits for Virtual Connections with *CNM* - Metro Ethernet Reporting (Cont'd)

The SLA credit amount will be determined by applying the credits outlined preceding to the rate elements or total billed revenues specified following:

The total credits issued for all SLAs for a specific BellSouth Metro Ethernet service Connection during a single bill period may not exceed the total monthly recurring charges billed for all the rate elements associated with that BellSouth Metro Ethernet service Connection. Credits are not provided for partial month service.

- (a) BellSouth Metro Ethernet Service Time-To-Repair Credit – The Service Level Commitment measurement will be based on each individual trouble ticket for a customer's connection. Multiple trouble tickets on the same day for the same customer connection will only be eligible for one time-to-repair credit. The SLA credit will apply to the monthly recurring charges for all the rate elements² associated with the affected Metro Ethernet Connection
- (b) BellSouth Metro Ethernet Service Network Availability Credit³ – The Service Level Commitment measurement will be based on a specific calendar month's performance. The credit will apply for each BellSouth Metro Ethernet Service Connection that does not meet the availability commitment. The SLA credit will apply to the monthly recurring charges for all the rate elements² associated with the affected Metro Ethernet Connection.
- (c) BellSouth Metro Ethernet Service Latency Credit³ – The Service Level Commitment measurement will be based on a specific calendar month's performance. The credit will apply for each BellSouth Metro Ethernet Service Connection that does not meet the latency Commitment for any eligible CoS. The SLA credit will apply to the monthly recurring charges for all the rate elements² associated with the affected Metro Ethernet Connection.
- (d) BellSouth Metro Ethernet Service Jitter Credit³ – The Service Level Commitment measurement will be based on a specific calendar month's performance. The credit will apply for each BellSouth Metro Ethernet Service Connection that does not meet the jitter Commitment for any eligible CoS. The SLA credit will apply to the monthly recurring charges for all the rate elements² associated with the affected Metro Ethernet Connection.
- (e) BellSouth Metro Ethernet Service Packet Delivery Credit³ – The Service Level Commitment measurement will be based on a specific calendar month's performance. The credit will apply for each BellSouth Metro Ethernet Service Connection that does not meet the packet delivery commitment for any eligible CoS. The SLA credit will apply to the monthly recurring charges for all the rate elements² associated with the affected Metro Ethernet Connection.

Note 1: Details of the technical measurements and performance results methodologies for each commitment are provided in BellSouth Technical Reference TR-73632.

Note 2: Specifically, rate elements for the Metro Ethernet Connection, Additional Mileage and Features.

Note 3: BellSouth Metro Ethernet networks that do not span more than one switch in the core network are not eligible for credits under this SLA.

Note 4: Effective on or after August 22, 2021, this Service will no longer be available for purchase by new or existing customers. In addition, requests to move, add, change, or renew existing service arrangements will not be accepted. Following the expiration of a customer's existing term agreement, service will be provided on a month-to-month basis at the applicable Monthly rates until the service is discontinued. The Company currently plans to discontinue this service on or after March 31, 2023.

(N)

(N)

BELLSOUTH
 TELECOMMUNICATIONS
 FLORIDA
 ISSUED: June 29, 2021
 BY: Joe York, President -FL
 Jacksonville, Florida

ACCESS SERVICES TARIFF

Fifth Revised Page 49
 Cancels Fourth Revised Page 49

EFFECTIVE: June 30, 2021

E7. DEDICATED ACCESS SERVICES

E7.5 Rates and Charges

E7.5.1 Reserved for Future Use

E7.5.2 Telegraph Grade (a.k.a. BellSouth® SPA Telegraph) Service^{1, 2}

(C)

A. Local Channel

1. Per Point of Termination

	Monthly Rate	Nonrecurring Charge		USOC
		First	Additional	
(a) Two-Wire	\$29.04	\$-	\$-	T6E2X
(b) Four-Wire	58.08	-	-	T6E4X

B. Interoffice Channel

1. Mileage Bands

	Fixed Monthly Charge	Monthly Charge Per Mile	Nonrecurring Charge Per Channel	USOC
(a) 0 mile	\$-	\$-	\$-	1L5XX
(b) 1 thru 8 miles	47.03	2.73	-	1L5XX
(c) 9 thru 25 miles	47.03	2.64	-	1L5XX
(d) Over 25 miles	47.03	2.56	-	1L5XX

C. Optional Features and Functions

1. Telegraph Bridging, Two-Wire and Four-Wire

	Monthly Rate	Nonrecurring Charge	USOC
(a) Two-Wire, per port	\$2.64	\$-	BCNT2
(b) Four-Wire, per port	2.64	-	BCNT4

Note 1: Telegraph Grade (a.k.a. BellSouth® SPA Telegraph) service is not available for additions, new installations or moves of service.

Note 2: Effective June 30, 2021, this Service will no longer be available for purchase by new or existing customers. In addition, requests to move, add, change, or renew existing service arrangements will not be accepted. Following the expiration of a customer's existing term agreement, service will be provided on a month-to-month basis at the applicable Monthly rates until the service is discontinued. The Company currently plans to discontinue this service on or after June 30, 2024.

(N)
 |
 (N)

BELLSOUTH
 TELECOMMUNICATIONS
 FLORIDA
 ISSUED: June 29, 2021
 BY: Joe York, President -FL
 Jacksonville, Florida

ACCESS SERVICES TARIFF

Sixth Revised Page 50
 Cancels Fifth Revised Page 50

EFFECTIVE: June 30, 2021

E7. DEDICATED ACCESS SERVICES

E7.5 Rates and Charges (Cont'd)

E7.5.3 Voice Grade² (a.k.a. BellSouth[®] SPA DS0 VG) Service

(C)

A. Local Channel

1. Per Point of Termination

a. Voice Grade (a.k.a. BellSouth[®] SPA DS0 VG)

(1) Voice

		Monthly Rate	Nonrecurring Charge		USOC
			First	Additional	
(a)	Two-Wire	<i>\$49.50</i>	<i>\$297.00</i>	<i>\$110.00</i>	T6E2X
(b)	Four-Wire	<i>74.25</i>	<i>302.50</i>	<i>115.50</i>	T6E4X
(2)	Data				
(a)	Two-Wire	<i>57.75</i>	<i>324.50</i>	<i>132.00</i>	T6E2X
(b)	Four-Wire	<i>74.25</i>	<i>330.00</i>	<i>137.50</i>	T6E4X
(3)	Loop Facilities not required ¹				
(a)	Two-Wire	<i>11.55</i>	<i>148.50</i>	<i>78.10</i>	EUC2N
(b)	Four-Wire	<i>11.55</i>	<i>148.50</i>	<i>78.10</i>	EUC4N

B. Interoffice Channel

1. Mileage Bands

	Fixed Monthly Charge	Monthly Charge Per Mile	Nonrecurring	USOC
			Charge Per Channel	
(a)	0 mile	\$-	\$-	1L5XX
(b)	1 thru 8 miles	<i>57.75</i>	<i>95.70</i>	1L5XX
(c)	9 thru 25 miles	<i>57.75</i>	<i>95.70</i>	1L5XX
(d)	Over 25 miles	<i>57.75</i>	<i>95.70</i>	1L5XX

Note 1: For connections to Company Centrex CO-like switches and equipment considered to be customer premises.

Note 2: Effective June 30, 2021, this Service will no longer be available for purchase by new or existing customers. In addition, requests to move, add, change, or renew existing service arrangements will not be accepted. Following the expiration of a customer's existing term agreement, service will be provided on a month-to-month basis at the applicable Monthly rates until the service is discontinued. The Company currently plans to discontinue this service on or after June 30, 2024.

(N)

(N)

BELLSOUTH
TELECOMMUNICATIONS
FLORIDA
ISSUED: June 29, 2021
BY: Joe York, President -FL
Jacksonville, Florida

ACCESS SERVICES TARIFF

Fifth Revised Page 51
Cancels Fourth Revised Page 51

EFFECTIVE: June 30, 2021

E7. DEDICATED ACCESS SERVICES**E7.5 Rates and Charges (Cont'd)****E7.5.3 Voice Grade¹ (a.k.a. BellSouth[®] SPA DS0 VG) Service (Cont'd)**

(C)

C. Optional Features and Functions**1. Bridging****a. Voice Bridging, Two-Wire/Four-Wire****(1) Per port**

(a) Two-Wire

**Monthly
Rate****Nonrecurring
Charge****USOC***\$11.55**\$37.40***BCNV2**

(b) Four-Wire

*11.55**37.40***BCNV4****b. Data Bridging, Two-Wire/Four-Wire****(1) Per port**

(a) Two-Wire

*16.50**40.70***BCND2**

(b) Four-Wire

*16.50**40.70***BCND4****c. Telephoto Bridging, Two-Wire/Four-Wire****(1) Per port**

(a) Two-Wire

*11.55**37.40***BCNF2**

(b) Four-Wire

*11.55**37.40***BCNF4****d. Dataphone[®] Select-A-Station Bridging - Primary
Data Station Selector****(1) Sequential Arrangement**

(a) Common Equipment

*188.93**264.00***DXNPS****(2) Addressable Arrangement**

(a) Common Equipment

*266.64**297.00***DXNPA****(3) Channel Connections**

(a) Per two-wire connection

*3.63**40.70***DXNP2**

(b) Per four-wire connection

*16.67**44.00***DXNP4****e. Dataphone[®] Select-A-Station Bridging - Secondary Data Station Selector****(1) Sequential Arrangement**

(a) Common Equipment

*188.93**264.00***DXNSS**

Note 1: Effective June 30, 2021, this Service will no longer be available for purchase by new or existing customers. In addition, requests to move, add, change, or renew existing service arrangements will not be accepted. Following the expiration of a customer's existing term agreement, service will be provided on a month-to-month basis at the applicable Monthly rates until the service is discontinued. The Company currently plans to discontinue this service on or after June 30, 2024.

(N)

(N)

BELLSOUTH
 TELECOMMUNICATIONS
 FLORIDA
 ISSUED: June 29, 2021
 BY: Joe York, President -FL
 Jacksonville, Florida

ACCESS SERVICES TARIFF

Fifth Revised Page 52
 Cancels Fourth Revised Page 52

EFFECTIVE: June 30, 2021

E7. DEDICATED ACCESS SERVICES

E7.5 Rates and Charges (Cont'd)

E7.5.3 Voice Grade¹ (A.K.A. BellSouth[®] SPA DS0 VG) Service (Cont'd)

(C)

C. Optional Features and Functions (Cont'd)

1. Bridging (Cont'd)

e. Dataphone[®] Select-A-Station Bridging - Secondary Data Station Selector (Cont'd)

(2) Addressable Arrangement

	Monthly Rate	Nonrecurring Charge	USOC
(a) Common Equipment	<i>\$266.64</i>	<i>\$297.00</i>	DXNSA
(3) Channel Connections			
(a) Per two-wire connection	<i>3.63</i>	<i>40.70</i>	DXNS2
(b) Per four-wire connection	<i>16.67</i>	<i>44.00</i>	DXNS4
f. Telemetry and Alarm Bridging - Split Band, Active Bridging			
(1) Common Equipment, per central office			
(a) First bridging shelf, capacity of 48 two-wire connections	69.65	380.00	DXQC1
(b) Additional bridging shelf, capacity of 56 two-wire connections installed subsequent to the first bridging shelf	67.65	345.00	DXQC2
(c) Additional bridging shelf, capacity of 56 two-wire connections installed at the same time as the first bridging shelf	23.25	215.00	XW8
(2) Channel connections, per channel connected			
(a) Remote station channel connection	1.40	37.00	DXQRX
(b) Mid-link channel connection, first channel	5.60	49.00	DXQM1
(c) Mid-link channel connection, subsequent channels	4.85	49.00	DXQMS

Note 1: Effective June 30, 2021, this Service will no longer be available for purchase by new or existing customers. In addition, requests to move, add, change, or renew existing service arrangements will not be accepted. Following the expiration of a customer's existing term agreement, service will be provided on a month-to-month basis at the applicable Monthly rates until the service is discontinued. The Company currently plans to discontinue this service on or after June 30, 2024.

(N)
 |
 (N)

BELLSOUTH
 TELECOMMUNICATIONS
 FLORIDA
 ISSUED: June 29, 2021
 BY: Joe York, President -FL
 Jacksonville, Florida

ACCESS SERVICES TARIFF

Fifth Revised Page 53
 Cancels Fourth Revised Page 53

EFFECTIVE: June 30, 2021

E7. DEDICATED ACCESS SERVICES

E7.5 Rates and Charges (Cont'd)

E7.5.3 Voice Grade³ (a.k.a. BellSouth[®] SPA DS0 VG) Service (Cont'd)

(C)

C. Optional Features and Functions (Cont'd)

2. Conditioning, Per Point of Termination

		Monthly	Nonrecurring Charge		
		Rate	Initial	Subsequent	
(a)	C-Type	<i>\$1.65</i>	<i>\$17.60</i>	<i>\$94.60</i>	USOC X1CPT
(b)	Improved Attenuation Distortion	<i>139.02</i>	<i>85.80</i>	<i>176.00</i>	UHW
(c)	Improved Envelope Delay Distortion	<i>193.53</i>	<i>85.80</i>	<i>176.00</i>	UHY
(d)	Sealing Current	<i>.58</i>	<i>37.40</i>	<i>104.50</i>	1HBPT
3.	Echo Control for Effective Two-Wire Service Per Point of Termination				
(a)	Improved Return Loss At the Two-Wire Point of Termination	<i>25.00</i>	<i>7.70</i>	<i>308.00</i>	1RL2W
(b)	ELEPL2 At the Four-Wire Point of Termination	<i>25.00</i>	<i>7.70</i>	<i>308.00</i>	UHZ
4.	Customer Specified Receive Level				
(a)	Per two-wire Point of Termination	<i>27.48</i>	<i>4.40</i>	<i>79.20</i>	RLS
5.	D-Conditioning				
(a)	Per Point of Termination	<i>.50</i>	<i>11.00</i>	<i>341.00</i>	XDCPT
6.	Telephoto Capability				
(a)	Per Point of Termination	<i>3.63</i>	<i>4.40</i>	<i>302.50</i>	XTCPT
7.	Signaling Capability, per Point of Termination				
(a)	Loop ¹	<i>4.87</i>	<i>17.60</i>	<i>319.00</i>	XSS++
(b)	Single Frequency	<i>9.49</i>	<i>25.30</i>	<i>324.50</i>	XSSSF
(c)	E&M ²	<i>15.68</i>	<i>27.50</i>	<i>330.00</i>	XSS++

Note 1: In lieu of ++ substitute LO or LS as appropriate.

Note 2: In lieu of ++ substitute EA, EB, EC, or CT as appropriate.

Note 3: Effective June 30, 2021, this Service will no longer be available for purchase by new or existing customers. In addition, requests to move, add, change, or renew existing service arrangements will not be accepted. Following the expiration of a customer's existing term agreement, service will be provided on a month-to-month basis at the applicable Monthly rates until the service is discontinued. The Company currently plans to discontinue this service on or after June 30, 2024.

(N)
 |
 (N)

BELLSOUTH
 TELECOMMUNICATIONS
 FLORIDA
 ISSUED: June 29, 2021
 BY: Joe York, President -FL
 Jacksonville, Florida

ACCESS SERVICES TARIFF

Sixth Revised Page 54
 Cancels Fifth Revised Page 54

EFFECTIVE: June 30, 2021

E7. DEDICATED ACCESS SERVICES

E7.5 Rates and Charges (Cont'd)

E7.5.3 Voice Grade⁴ (a.k.a. BellSouth[®] SPA DS0 VG) Service (Cont'd)

(C)

C. Optional Features and Functions (Cont'd)

7. Signaling Capability, per Point of Termination

	Monthly Rate	Nonrecurring Charge		USOC
		Initial	Subsequent	
(d) Ground ¹	\$3.96	\$12.10	\$313.50	XSS++
(e) Type C	3.96	17.60	319.00	XSSLC
(f) Other ²	9.49	20.90	324.50	XSS++
8. Improved Termination				
(a) Per Point of Termination	3.63	4.40	308.00	UGD
9. Simplex Reversal				
(a) Per Point of Termination	-	4.40	95.70	UGJ

E7.5.4 Reserved For Future Use

E7.5.5 Digital Data Access (a.k.a. BellSouth[®] SPA DS0 Digital Data) Service^{3,4}

(C)

A. Local Channel

1. Per Point of Termination

	Monthly Rate	Nonrecurring Charge		USOC
		First	Additional	
(a) 2.4 Kbps	\$55.00	\$350.00	\$99.00	T6ECS
(b) 4.8 Kbps	55.00	350.00	99.00	T6ECS
(c) 9.6 Kbps	55.00	350.00	99.00	T6ECS

Note 1: In lieu of ++ substitute GO or GS as appropriate.

Note 2: In lieu of ++ substitute LA, LB, LR, RV, DX, DY, EX, AB or AC as appropriate.

Note 3: Rates and charges for BellSouth.

Note 4: Effective June 30, 2021, this Service will no longer be available for purchase by new or existing customers. In addition, requests to move, add, change, or renew existing service arrangements will not be accepted. Following the expiration of a customer's existing term agreement, service will be provided on a month-to-month basis at the applicable Monthly rates until the service is discontinued. The Company currently plans to discontinue this service on or after June 30, 2024.

(N)

(N)

BELLSOUTH
 TELECOMMUNICATIONS
 FLORIDA
 ISSUED: June 29, 2021
 BY: Joe York, President -FL
 Jacksonville, Florida

ACCESS SERVICES TARIFF

Sixth Revised Page 55
 Cancels Fifth Revised Page 55

EFFECTIVE: June 30, 2021

E7. DEDICATED ACCESS SERVICES

E7.5 Rates and Charges (Cont'd)

E7.5.5 Digital Data Access (a.k.a. BellSouth SPA DS0 Digital Data) Service^{1,3} (Cont'd)

(C)

A. Local Channel (Cont'd)

1. Per Point of Termination (Cont'd)

	Monthly Rate	Nonrecurring Charge		USOC
		First	Additional	
(d) 19.2 Kbps	\$55.00	\$350.00	\$99.00	T6ECS
(e) 56.0 Kbps	75.00	350.00	99.00	T6ECS
(f) 64.0 Kbps	75.00	350.00	99.00	T6ECS

2. Hub Termination, Per Local Channel

	Monthly Rate	First	Additional	USOC
(a) 2.4 Kbps	11.00	57.00	48.00	TUTA4
(b) 4.8 Kbps	11.00	57.00	48.00	TUTB4
(c) 9.6 Kbps	11.00	57.00	48.00	TUTC4
(d) 19.2 Kbps	11.00	57.00	48.00	TUTE4
(e) 56.0 Kbps	30.00	57.00	48.00	TUTD4
(f) 64.0 Kbps	30.00	57.00	48.00	TUTF4

3. Local Channel Contract Rates Per Point of Termination

	Monthly Rate	Nonrecurring Charge		USOC
		First	Add'l	
(a) 2.4 Kbps	\$350.00	\$99.00	\$49.00	T6ECS
(b) 4.8 Kbps	350.00	99.00	49.00	T6ECS
(c) 9.6 Kbps	350.00	99.00	49.00	T6ECS
(d) 19.2 Kbps	350.00	99.00	49.00	T6ECS
(e) 56.0 Kbps	350.00	99.00	65.00	T6ECS
(f) 64.0 Kbps	350.00	99.00	65.00	T6ECS

4. Contract Rates for Hub Termination, Per Local Channel

	Monthly Rate	First	24 to 42 Months ²	43 to 60 Months ²	USOC
(a) 2.4 Kbps	57.00	48.00	9.75	9.50	TUTA4
(b) 4.8 Kbps	57.00	48.00	9.75	9.50	TUTB4
(c) 9.6 Kbps	57.00	48.00	9.75	9.50	TUTC4
(d) 19.2 Kbps	57.00	48.00	9.75	9.50	TUTE4
(e) 56.0 Kbps	57.00	48.00	28.00	26.00	TUTD4

Note 1: Rates and charges for BellSouth.

Note 2: Effective March 23, 2019, Customers may not convert, renew or establish CSPPs for Digital Data Access Service.

Note 3: Effective June 30, 2021, this Service will no longer be available for purchase by new or existing customers. In addition, requests to move, add, change, or renew existing service arrangements will not be accepted. Following the expiration of a customer's existing term agreement, service will be provided on a month-to-month basis at the applicable Monthly rates until the service is discontinued. The Company currently plans to discontinue this service on or after June 30, 2024.

(N)
 |
 (N)

BELLSOUTH
 TELECOMMUNICATIONS
 FLORIDA
 ISSUED: June 29, 2021
 BY: Joe York, President -FL
 Jacksonville, Florida

ACCESS SERVICES TARIFF

Fifth Revised Page 56
 Cancels Fourth Revised Page 56

EFFECTIVE: June 30, 2021

E7. DEDICATED ACCESS SERVICES

E7.5 Rates and Charges (Cont'd)

E7.5.5 Digital Data Access (a.k.a. BellSouth SPA DS0 Digital Data) Service^{1,3} (Cont'd)

(C)

A. Local Channel (Cont'd)

4. Contract Rates for Hub Termination, Per Local Channel (Cont'd)

Nonrecurring Charge		24 to	43 to	USOC
First	Add'l	Months ²	Months ²	
\$57.00	\$48.00	\$28.00	\$26.00	TUTF4

B. Interoffice Channel

1. 2.4 Kbps

Mileage Bands

- (a) 0 mile
- (b) 1 thru 8 miles
- (c) 9 thru 25 miles
- (d) Over 25 miles

Fixed Monthly Rate	Monthly Rate Per Mile	Nonrecurring Charge Per Channel	USOC
\$-	\$-	\$-	1L5XX
20.00	2.05	36.00	1L5XX
20.00	2.00	36.00	1L5XX
20.00	1.95	36.00	1L5XX

2. 4.8 Kbps

Mileage Bands

- (a) 0 mile
- (b) 1 thru 8 miles
- (c) 9 thru 25 miles
- (d) Over 25 miles

-	-	-	1L5XX
20.00	2.05	36.00	1L5XX
20.00	2.00	36.00	1L5XX
20.00	1.95	36.00	1L5XX

3. 9.6 Kbps

Mileage Bands

- (a) 0 mile
- (b) 1 thru 8 miles

-	-	-	1L5XX
20.00	2.05	36.00	1L5XX

Note 1: Rates and charges for BellSouth.

Note 2: Effective March 23, 2019, Customers may not convert, renew or establish CSPPs for Digital Data Access Service.

Note 3: Effective June 30, 2021, this Service will no longer be available for purchase by new or existing customers. In addition, requests to move, add, change, or renew existing service arrangements will not be accepted. Following the expiration of a customer's existing term agreement, service will be provided on a month-to-month basis at the applicable Monthly rates until the service is discontinued. The Company currently plans to discontinue this service on or after June 30, 2024.

(N)
 |
 (N)

BELLSOUTH
 TELECOMMUNICATIONS
 FLORIDA
 ISSUED: June 29, 2021
 BY: Joe York, President -FL
 Jacksonville, Florida

ACCESS SERVICES TARIFF

Fourth Revised Page 57
 Cancels Third Revised Page 57

EFFECTIVE: June 30, 2021

E7. DEDICATED ACCESS SERVICES

E7.5 Rates and Charges (Cont'd)

E7.5.5 Digital Data Access (a.k.a. BellSouth SPA DS0 Digital Data) Service^{1, 2} (Cont'd)

(C)(T)

B. Interoffice Channel (Cont'd)

3. 9.6 Kbps (Cont'd)

		Fixed Monthly Rate	Monthly Rate Per Mile	Nonrecurring Charge Per Channel	USOC
(c)	9 thru 25 miles	\$20.00	\$2.00	\$36.00	1L5XX
(d)	Over 25 miles	20.00	1.95	36.00	1L5XX

4. 19.2 Kbps

Mileage Bands

(a)	0 mile	-	-	-	1L5XX
(b)	1 thru 8 miles	20.00	2.05	36.00	1L5XX
(c)	9 thru 25 miles	20.00	2.00	36.00	1L5XX
(d)	Over 25 miles	20.00	1.95	36.00	1L5XX

5. 56 Kbps

Mileage Bands

(a)	0 mile	-	-	-	1L5XX
(b)	1 thru 8 miles	40.00	4.10	36.00	1L5XX
(c)	9 thru 25 miles	40.00	4.00	36.00	1L5XX
(d)	Over 25 miles	40.00	3.90	36.00	1L5XX

6. 64 Kbps

Mileage Bands

(a)	0 mile	-	-	-	1L5XX
(b)	1 thru 8 miles	40.00	4.10	36.00	1L5XX
(c)	9 thru 25 miles	40.00	4.00	36.00	1L5XX
(d)	Over 25 miles	40.00	3.90	36.00	1L5XX

Note 1: Rates and charges for BellSouth.

Note 2: Effective June 30, 2021, this Service will no longer be available for purchase by new or existing customers. In addition, requests to move, add, change, or renew existing service arrangements will not be accepted. Following the expiration of a customer's existing term agreement, service will be provided on a month-to-month basis at the applicable Monthly rates until the service is discontinued. The Company currently plans to discontinue this service on or after June 30, 2024.

(N)
 |
 (N)

BELLSOUTH
 TELECOMMUNICATIONS
 FLORIDA
 ISSUED: June 29, 2021
 BY: Joe York, President -FL
 Jacksonville, Florida

ACCESS SERVICES TARIFF

Fifth Revised Page 58
 Cancels Fourth Revised Page 58

EFFECTIVE: June 30, 2021

E7. DEDICATED ACCESS SERVICES

E7.5 Rates and Charges (Cont'd)

E7.5.5 Digital Data Access (a.k.a. BellSouth SPA DS0 Digital Data) Service^{1, 5} (Cont'd)

(C)

B. Interoffice Channel (Cont'd)

7. 2.4, 4.8, 9.6 and 19.2 Kbps (Contract Rates)

Mileage Bands

	Nonrecurring Charge	Monthly Rate				USOC
		Fixed Monthly Rate		Per Mile		
		24 to 42 Months ⁴	43 to 60 Months ⁴	24 to 42 Months ⁴	43 to 60 Months ⁴	
(a) 0 mile	\$-	\$-	\$-	\$-	\$-	1L5XX
(b) 1 thru 8 miles	36.00	19.50	19.00	1.90	1.75	1L5XX
(c) 9 thru 25 miles	36.00	19.50	19.00	1.85	1.70	1L5XX
(d) Over 25 miles	36.00	19.50	19.00	1.80	1.65	1L5XX

8. 56.0 and 64.0 Kbps (Contract Rates)

Mileage Bands

(a) 0 mile	-	-	-	-	-	1L5XX
(b) 1 thru 8 miles	36.00	36.00	34.00	3.80	3.50	1L5XX
(c) 9 thru 25 miles	36.00	36.00	34.00	3.70	3.40	1L5XX
(d) Over 25 miles	36.00	36.00	34.00	3.60	3.30	1L5XX

C. Optional Features and Functions

1. Bridging^{2,3}

	Rate	Monthly Nonrecurring Charge	USOC
(a) Per port (2.4, 4.8, 9.6, 19.2, 56.0 Kbps)	\$15.00	\$20.00	BCNDA

2. Digital Data Secondary Channel Capability, per Local Channel^{2,3}

	Monthly Rate	Nonrecurring Charge	USOC
(a) Each	\$15.00	Initial \$- Subsequent \$235.00	SFS

Note 1: Rates and charges for BellSouth.

Note 2: Not available at all service locations.

Note 3: This option is not available with 64.0 Kbps.

Note 4: Effective March 23, 2019, Customers may not convert, renew or establish CSPPs for Digital Data Access Service.

Note 5: Effective June 30, 2021, this Service will no longer be available for purchase by new or existing customers. In addition, requests to move, add, change, or renew existing service arrangements will not be accepted. Following the expiration of a customer's existing term agreement, service will be provided on a month-to-month basis at the applicable Monthly rates until the service is discontinued. The Company currently plans to discontinue this service on or after June 30, 2024.

(N)
 |
 (N)

BELLSOUTH
 TELECOMMUNICATIONS
 FLORIDA
 ISSUED: June 29, 2021
 BY: Joe York, President -FL
 Jacksonville, Florida

ACCESS SERVICES TARIFF

Sixth Revised Page 59
 Cancels Fifth Revised Page 59

EFFECTIVE: June 30, 2021

E7. DEDICATED ACCESS SERVICES

E7.5 Rates and Charges (Cont'd)

E7.5.5 Digital Data Access (a.k.a. BellSouth SPA DS0 Digital Data) Service^{1,5} (Cont'd)

(C)

C. Optional Features and Functions (Cont'd)

3. Contract Rates For Bridging^{2,3}

		Nonrecurring	24 to	43 to	
		Charge	42	60	
	(a) Per port (2.4, 4.8, 9.6, 19.2, 56.0 Kbps)	\$20.00	Months⁴	Months⁴	USOC
4.	Contract Rates for Digital Data Secondary Channel, per Local Channel ^{2,3}		\$13.00	\$12.00	BCNDA

		Nonrecurring	24 to	43 to	
		Charge	42	60	
	(a) Each	Initial	Months⁴	Months⁴	USOC
		\$-	\$14.00	\$13.00	SFS
		Subsequent			
		\$235.00			

Note 1: Rates and charges for BellSouth..

Note 2: Not available at all service locations.

Note 3: This option is not available with 64.0 Kbps.

Note 4: Effective March 23, 2019, Customers may not convert, renew or establish CSPPs for Digital Data Access Service.

Note 5: Effective June 30, 2021, this Service will no longer be available for purchase by new or existing customers. In addition, requests to move, add, change, or renew existing service arrangements will not be accepted. Following the expiration of a customer's existing term agreement, service will be provided on a month-to-month basis at the applicable Monthly rates until the service is discontinued. The Company currently plans to discontinue this service on or after June 30, 2024.

(N)
 |
 (N)

BELLSOUTH
 TELECOMMUNICATIONS
 FLORIDA
 ISSUED: March 15, 2024
 BY: Joe York, President -FL
 Jacksonville, Florida

ACCESS SERVICES TARIFF

Fifth Revised Page 60
 Cancels Fourth Revised Page 60

EFFECTIVE: March 17, 2024

E7. DEDICATED ACCESS SERVICES

E7.5 Rates and Charges (Cont'd)

E7.5.6 High Capacity (a.k.a. BellSouth SPA High Capacity) Service

A. Local Channel

1. Per Point of Termination

		Monthly Rate			Nonrecurring Charge		USOC
		Rate Zone 1	Rate Zone 2	Rate Zone 3	First	Additional	
(a)	1.544 Mbps	\$145.00	\$145.00	\$145.00	\$745.00	\$335.00	TMECS
(b)	3.152 Mbps ¹	-	-	-	-	-	1XA++
(c)	6.312 Mbps ¹	-	-	-	-	-	1X6++
(d)	44.736 Mbps ¹	-	-	-	-	-	1X8++

2. 1.544 Mbps Contract Rates

		Nonrecurring Charge			USOC
		First	Additional		
(a)	Per Point of Termination ²	\$745.00	\$335.00		-
		Monthly Rate			USOC
		24 to 48 Months ^{3, 4, 5}	49 to 72 Months ^{3, 4}	73 to 96 Months ^{3, 4}	
(b)	Rate Zone 1	\$138.00	\$136.00	\$134.00	TMECS
(c)	Rate Zone 2	138.00	136.00	134.00	TMECS
(d)	Rate Zone 3	138.00	136.00	134.00	TMECS

Note 1: ICB rates and charges apply.

Note 2: Contract lengths are flexible to allow customer choice of payment period per E2.4.9.

Note 3: Effective March 23, 2019, Customers may not: (1) Establish CSPPs greater than 36 months for High Capacity Service, and (2) Convert or renew CSPPs for High Capacity Service.

Note 4: Effective November 1, 2022, customers may not establish new term plans of greater than 24 months for High Capacity Service Channel Service Payment Plans.

Note 5: Effective March 17, 2024, customers may not establish new term plans of greater than month-to-month for High Capacity Service Channel Service Payment Plans.

(N)

BELLSOUTH
 TELECOMMUNICATIONS
 FLORIDA
 ISSUED: March 15, 2024
 BY: Joe York, President -FL
 Jacksonville, Florida

ACCESS SERVICES TARIFF

Fifth Revised Page 61
 Cancels Fourth Revised Page 61

EFFECTIVE: March 17, 2024

E7. DEDICATED ACCESS SERVICES

E7.5 Rates and Charges (Cont'd)

E7.5.6 High Capacity (a.k.a. BellSouth SPA High Capacity) Service (Cont'd)

B. Interoffice Channel

- 1. 1.544 Mbps

Mileage Bands

	Fixed Monthly Rate			Monthly Rate Per Mile			Nonrecurring Charge Per Channel	USOC
	Rate Zone 1	Rate Zone 2	Rate Zone 3	Rate Zone 1	Rate Zone 2	Rate Zone 3		
	(a) 0 mile	\$-	\$-	\$-	\$-	\$-		
(b) 1 thru 8 miles	64.35	64.35	64.35	26.00	26.00	26.00	200.00	1L5XX
(c) 9 thru 25 miles	64.35	64.35	64.35	25.00	25.00	25.00	200.00	1L5XX
(d) Over 25 miles	64.35	64.35	64.35	24.00	24.00	24.00	200.00	1L5XX

- 2. 1.544 Mbps

Mileage Bands

a. Contract Rates¹

- (1) Per Channel, 0 Mile

	Nonrecurring Charge	Fixed Monthly Charge				USOC
		24 to 48 Months ^{2,3,4}	49 to 72 Months ^{2,3}	73 to 96 Months ^{2,3}		
(a) Rate Zone 1	\$-	\$-	\$-	\$-	1L5XX	
(b) Rate Zone 2	200.00	59.75	-	-	1L5XX	
(c) Rate Zone 3	200.00	59.75	-	-	1L5XX	
(2) Per Channel, 1 thru 8 miles						
(a) Rate Zone 1	200.00	59.75	20.00	18.00	16.00	1L5XX
(b) Rate Zone 2	200.00	59.75	20.00	18.00	16.00	1L5XX
(c) Rate Zone 3	200.00	59.75	20.00	18.00	16.00	1L5XX
(3) Per Channel, 9 thru 25 miles						
(a) Rate Zone 1	200.00	59.75	19.00	17.00	15.00	1L5XX
(b) Rate Zone 2	200.00	59.75	19.00	17.00	15.00	1L5XX
(c) Rate Zone 3	200.00	59.75	19.00	17.00	15.00	1L5XX
(4) Per Channel, Over 25 Miles						
(a) Rate Zone 1	200.00	59.75	18.00	16.00	14.00	1L5XX
(b) Rate Zone 2	200.00	59.75	18.00	16.00	14.00	1L5XX
(c) Rate Zone 3	200.00	59.75	18.00	16.00	14.00	1L5XX

(C)

Note 1: Contract lengths are flexible to allow customer choice of payment period per E2.4.9.

Note 2: Effective March 23, 2019, Customers may not: (1) Establish CSPPs greater than 36 months for High Capacity Service, and (2) Convert or renew CSPPs for High Capacity Service.

Note 3: Effective November 1, 2022, customers may not establish new term plans of greater than 24 months for High Capacity Service Channel Service Payment Plans.

Note 4: Effective March 17, 2024, customers may not establish new term plans of greater than month-to-month for High Capacity Service Channel Service Payment Plans.

(N)

BELLSOUTH
TELECOMMUNICATIONS, INC.
FLORIDA

ACCESS SERVICES TARIFF

Second Revised Page 62
Cancels First Revised Page 62

ISSUED: November 16, 2001
BY: Joseph P. Lacher, President -FL
Miami, Florida

EFFECTIVE: December 17, 2001

E7. DEDICATED ACCESS SERVICES

E7.5 Rates and Charges (Cont'd)

E7.5.6 High Capacity (a.k.a. BellSouth SPA High Capacity) Service (Cont'd)

B. Interoffice Channel (Cont'd)

3. 3.152 Mbps¹ (M)(T)
Mileage Bands (M)

	Fixed Monthly Rate	Monthly Rate Per Mile	Nonrecurring Charge Per Channel	USOC	
(a) 0 mile	\$-	\$-	\$-	1L5XX	(M)
(b) 1 thru 8 miles	-	-	-	1L5XX	(M)
(c) 9 thru 25 miles	-	-	-	1L5XX	(M)
(d) Over 25 miles	-	-	-	1L5XX	(M)

4. 6.312 Mbps¹
Mileage Bands

	Fixed Monthly Rate	Monthly Rate Per Mile	Nonrecurring Charge Per Channel	USOC	
(a) 0 mile	\$-	\$-	\$-	1L5XX	
(b) 1 thru 8 miles	-	-	-	1L5XX	
(c) 9 thru 25 miles	-	-	-	1L5XX	
(d) Over 25 miles	-	-	-	1L5XX	

5. 44.736 Mbps¹
Mileage Bands

	Fixed Monthly Rate	Monthly Rate Per Mile	Nonrecurring Charge Per Channel	USOC	
(a) 0 mile	-	-	-	1L5XX	
(b) 1 thru 8 miles	-	-	-	1L5XX	
(c) 9 thru 25 miles	-	-	-	1L5XX	
(d) Over 25 miles	-	-	-	1L5XX	

(M)

Note 1: ICB rates and charges apply.

BELLSOUTH
 TELECOMMUNICATIONS
 FLORIDA
 ISSUED: March 15, 2024
 BY: Joe York, President -FL
 Jacksonville, Florida

ACCESS SERVICES TARIFF

Sixth Revised Page 63
 Cancels Fifth Revised Page 63

EFFECTIVE: March 17, 2024

E7. DEDICATED ACCESS SERVICES

E7.5 Rates and Charges (Cont'd)

E7.5.6 High Capacity (a.k.a. BellSouth SPA High Capacity) Service (Cont'd)

C. Optional Features and Functions

1. Channelization

a. DS3 Channelization

(1) DS3 to DS1

(a) Per arrangement¹

b. DS2 Channelization

(1) DS2 to DS1

(a) Per arrangement¹

c. DS1C Channelization

(1) DS1C to DS1

(a) Per arrangement²

d. DS1 Channelization

(1) DS1 Basic Channelization System (DS1 to VG/DS0)

(a) Per System

e. DS0 Channelization⁴

(1) DS0 Basic Channelization System (DS0 to Subrate)

(Per System)

(a) Maximum of 20, 2.4 Kbps services

(b) Maximum of 10, 4.8 Kbps services

(c) Maximum of 5, 9.6 Kbps services

2. Channel Interfaces (Per Interface)

a. Sub-DS3 Interfaces

(1) DS1 Level Central Office Channel Interface¹

(a) Asynchronous

(b) Synchronous

(2) DS1 Level Customer Channel Interface¹

(a) Asynchronous

(b) Synchronous

Monthly Nonrecurring

Rate	Charge	USOC
\$-	\$-	MXB++

Monthly Rate

Rate	Rate	Rate	Nonrecurring	USOC
Zone 1	Zone 2	Zone 3	Charge	
\$210.00	\$210.00	\$210.00	\$135.00	MQ1

Monthly Nonrecurring

Rate	Charge	USOC
\$120.00	\$135.00	QSU24
120.00	135.00	QSU48
120.00	135.00	QSU96

	Nonrecurring Charge	Month To Month	24 to 48	49 to 72	73 to 96	USOC
			Months ^{3,4,5,6}	Months ^{3,4}	Months ^{3,4}	
(a) Asynchronous	\$155.00	\$12.00	\$8.00	\$7.00	\$6.00	1D3CA
(b) Synchronous	130.00	36.00	31.00	28.00	25.00	1D3CS
(a) Asynchronous	295.00	17.00	13.00	13.00	13.00	1D3DA
(b) Synchronous	245.00	45.00	36.00	33.00	30.00	1D3DS

Note 1: Contract rates are flexible to allow customer choice of payment period per E2.4.9

Note 2: An additional Local Channel charge will apply whenever the spare line is provided as a leg to the customer premises. This feature may not be available with lines utilizing the Clear Channel Capability line code (B8ZS).

Note 3: Effective March 23, 2019, Customers may not: (1) Establish CSPPs greater than 36 months for High Capacity Service, and (2) Convert or renew CSPPs for High Capacity Service.

Note 4: Effective June 30, 2021, this Service will no longer be available for purchase by new or existing customers. In addition, requests to move, add, change, or renew existing service arrangements will not be accepted. Following the expiration of a customer's existing term agreement, service will be provided on a month-to-month basis at the applicable Monthly rates until the service is discontinued. The Company currently plans to discontinue this service on or after June 30, 2024.

Note 5: Effective November 1, 2022, customers may not establish new term plans of greater than 24 months for High Capacity Service Channel Service Payment Plans.

Note 6: Effective March 17, 2024, customers may not establish new term plans of greater than month-to-month for High Capacity Service Channel Service Payment Plans.

BELLSOUTH
 TELECOMMUNICATIONS
 FLORIDA
 ISSUED: June 29, 2021
 BY: Joe York, President -FL
 Jacksonville, Florida

ACCESS SERVICES TARIFF

Fifth Revised Page 64
 Cancels Fourth Revised Page 64

EFFECTIVE: June 30, 2021

E7. DEDICATED ACCESS SERVICES

E7.5 Rates and Charges (Cont'd)

E7.5.6 High Capacity (a.k.a. BellSouth® SPA High Capacity) Service (Cont'd)

C. Optional Features and Functions (Cont'd)

2. Channel Interfaces (Per Interface) (Cont'd)

b. Sub-DS1 Interfaces

(1) VG/DS0 Level Central Office Channel Interface¹

	Nonrecurring Charge		Month		
	First	Each	to	USOC	
		Additional	Month		
(a) BellSouth® SWA	\$ 0.00	\$ 0.00	\$ 0.00	1D1SW	
(b) Telegraph ² (BellSouth® SPA Telegraph)	7.00	6.00	5.00	1D1TE	(C)
(c) Voice ² (BellSouth® SPA DSO VG)	7.00	6.00	9.00	1D1VG	(C)
(d) DDAS ² (BellSouth® SPA DSO Digital Data)	7.00	6.00	13.00	1D1DD	(C)
c. Sub-DS0 Interfaces ² (C)					
(1) Subrate Central Office Channel Interface ¹					
(a) Subrate (2.4, 4.8, & 9.6 Kbps)	7.00	6.00	13.00	1DOSR	

4. Clear Channel Capability is furnished on a per DS1 service channel basis.

Per DS1/1.544 Mbps High Capacity Channel optioned as:

(a) Superframe Format (SF)	-	-	655.00	CCOSF
(b) Extended Superframe Format (ESF)	-	-	655.00	CCOEF

Note 1: Contract rates are flexible to allow customer choice of payment period per E2.4.9.

Note 2: Effective June 30, 2021, this Service will no longer be available for purchase by new or existing customers. In addition, requests to move, add, change, or renew existing service arrangements will not be accepted. Following the expiration of a customer's existing term agreement, service will be provided on a month-to-month basis at the applicable Monthly rates until the service is discontinued. The Company currently plans to discontinue this service on or after June 30, 2024.

(N)
 |
 (N)

BELLSOUTH
TELECOMMUNICATIONS
FLORIDA

ACCESS SERVICES TARIFF

Second Revised Page 65
Cancels First Revised Page 65

ISSUED: June 21, 2012
BY: Marshall M. Criser III, President -FL
Miami, Florida

EFFECTIVE: June 22, 2012

E7. DEDICATED ACCESS SERVICES

E7.5 Rates and Charges (Cont'd)

(DELETE)

(D)

BELLSOUTH
TELECOMMUNICATIONS
FLORIDA

ACCESS SERVICES TARIFF

Second Revised Page 66
Cancels First Revised Page 66

ISSUED: June 21, 2012

EFFECTIVE: June 22, 2012

BY: Marshall M. Criser III, President -FL
Miami, Florida

E7. DEDICATED ACCESS SERVICES

E7.5 Rates and Charges (Cont'd)

(DELETE)

(D)

BELLSOUTH
TELECOMMUNICATIONS
FLORIDA

ACCESS SERVICES TARIFF

Second Revised Page 67
Cancels First Revised Page 67

ISSUED: June 21, 2012

EFFECTIVE: June 22, 2012

BY: Marshall M. Criser III, President -FL
Miami, Florida

E7. DEDICATED ACCESS SERVICES

E7.5 Rates and Charges (Cont'd)

(DELETE)

(D)

BELLSOUTH
TELECOMMUNICATIONS
FLORIDA

ACCESS SERVICES TARIFF

Second Revised Page 68
Cancels First Revised Page 68

ISSUED: June 21, 2012
BY: Marshall M. Criser III, President -FL
Miami, Florida

EFFECTIVE: June 22, 2012

E7. DEDICATED ACCESS SERVICES

E7.5 Rates and Charges (Cont'd)

(DELETE)

(D)

E7.5.7 Reserved for Future Use

(C)

(D)

BELLSOUTH
 TELECOMMUNICATIONS
 FLORIDA
 ISSUED: June 29, 2021
 BY: Joe York, President -FL
 Jacksonville, Florida

ACCESS SERVICES TARIFF

Fifth Revised Page 69
 Cancels Fourth Revised Page 69

EFFECTIVE: June 30, 2021

E7. DEDICATED ACCESS SERVICES

E7.5 Rates and Charges (Cont'd)

E7.5.9 Reserved for Future Use

E7.5.10 Reserved for Future Use

E7.5.11 Reserved for Future Use

E7.5.12 Reconfiguration Charges

A. Rates and Charges

(1) Per Customer Request for Voice Grade ¹ (a.k.a. BellSouth [®] SPA DS0 VG) reconfiguration			(C)
	Nonrecurring		
	Charge	USOC	
(a) Each	\$33.00	PR1VM	
(b) Per Voice Grade ¹ (a.k.a. BellSouth [®] SPA DS0 VG) circuit reconfigured	23.00	PR1VR	(C)
(2) Per Customer Request for DDAS ¹ (a.k.a. BellSouth [®] SPA DS0 Digital Data) reconfiguration			(C)
(a) Each	33.00	PR1DM	
(b) Per DDAS ¹ (a.k.a. BellSouth [®] SPA DS0 Digital Data) circuit reconfigured	23.00	PR1DR	(C)
(3) Per Customer Request for DS1 reconfiguration			
(a) Each	52.00	PR11M	
(b) Per DS1 circuit reconfigured	33.00	PR11R	

E7.5.13 Transfer of Service

A. Transfer of Service

1. Dedicated Access Circuits

(a) Per Billing Account Number	50.00	NRBPA	
(b) Per circuit	6.00	NRBPC	

E7.5.14 (DELETED)

Note 1: Effective June 30, 2021, this Service will no longer be available for purchase by new or existing customers. In addition, requests to move, add, change, or renew existing service arrangements will not be accepted. Following the expiration of a customer's existing term agreement, service will be provided on a month-to-month basis at the applicable Monthly rates until the service is discontinued. The Company currently plans to discontinue this service on or after June 30, 2024.

(N)
 |
 (N)

BELLSOUTH
TELECOMMUNICATIONS, INC.
FLORIDA

ACCESS SERVICES TARIFF

Third Revised Page 70
Cancels Second Revised Page 70

ISSUED: November 30, 2001
BY: Joseph P. Lacher, President -FL
Miami, Florida

EFFECTIVE: December 30, 2001

E7. DEDICATED ACCESS SERVICES

E7.5 Rates and Charges (Cont'd)

E7.5.14 (DELETED)

(D)

BELLSOUTH
 TELECOMMUNICATIONS
 FLORIDA
 ISSUED: June 29, 2021
 BY: Joe York, President -FL
 Jacksonville, Florida

ACCESS SERVICES TARIFF

Fifth Revised Page 71
 Cancels Fourth Revised Page 71

EFFECTIVE: June 30, 2021

E7. DEDICATED ACCESS SERVICES

E7.5 Rates and Charges (Cont'd)

E7.5.14 (DELETED)

E7.5.15 Derived Data Channel² (a.k.a. BellSouth SPA Derived Data Channel) Service

(C)

A. Local Channel

1. Derived Data Channel (a.k.a. BellSouth SPA Derived Data Channel)

	Nonrecurring Charge	Month to Month	24 to 42 Months¹	43 to 60 Months¹	USOC
(a) Per channel at 2.4 Kbps	\$460.00	\$17.00	\$13.50	\$11.00	DAXPC
2. DS0-B Interface					
(a) Per group of twenty channels at 2.4 Kbps each	330.00	70.00	65.00	62.00	DAXP1

B. Interoffice Channel

1. Per group of twenty channels at 2.4 Kbps each

(a) Fixed	95.00	25.00	23.00	22.00	DAXPF
(b) Per mile	-	2.05	1.90	1.75	DAXPM

Note 1: Effective March 23, 2019, Customers may not convert, renew or establish CSPPs for Derived Data Channel Service.

Note 2: Effective June 30, 2021, this Service will no longer be available for purchase by new or existing customers. In addition, requests to move, add, change, or renew existing service arrangements will not be accepted. Following the expiration of a customer's existing term agreement, service will be provided on a month-to-month basis at the applicable Monthly rates until the service is discontinued. The Company currently plans to discontinue this service on or after June 30, 2024.

(N)
 |
 (N)

BELLSOUTH
 TELECOMMUNICATIONS
 FLORIDA
 ISSUED: March 22, 2019
 BY: Joe York, President -FL
 Jacksonville, Florida

ACCESS SERVICES TARIFF

Fifth Revised Page 72
 Cancels Fourth Revised Page 72

EFFECTIVE: March 23, 2019

E7. DEDICATED ACCESS SERVICES

E7.5 Rates and Charges (Cont'd)

E7.5.16 FlexServ Service (a.k.a. BellSouth SPA Customer Reconfiguration)

A. Basic FlexServ service (a.k.a. BellSouth SPA Customer Reconfiguration)

1. DS0 Channel Connections

	Nonrecurring Charge	Month To Month	24 to 48 Months ²	49 to 72 Months ²	73 to 96 Months ²	USOC DSLVA	(N)
(a) Voice Grade Type, per DS0 channel	\$35.00	\$14.90	\$13.70	\$12.70	\$11.90	DSLVA	
(b) Digital Type, per DS0 channel	35.00	8.50	7.80	7.25	6.80	DSLDA	

2. DS1 Channel Connections

(a) DS0 Switching, per DS1 channel	125.00	110.00	100.00	92.00	85.00	DSL1A	
(b) DS1 Switching, per DS1 channel	125.00	65.00	60.00	55.00	52.00	DSL1B	
(c) Surveillance - DS1 Level per DS1 channel	125.00	65.00	60.00	55.00	52.00	DSL1S	

3. DS3 Channel Connections

(a) Surveillance - DS1 Level, per DS3 channel	125.00	375.00	345.00	320.00	300.00	DSL3S	
(b) Surveillance - DS3 Level, per DS3 channel	125.00	150.00	138.00	128.00	120.00	DSL3T	

B. FlexServ service (a.k.a. BellSouth SPA Customer Reconfiguration) Options

1. Multipoint Bridging

(a) Voice Grade Connections, per bridging leg	20.00	5.00	4.50	4.40	4.30	FSSF9	
(b) Multipoint Junction Unit, per 2.4, 4.8, 9.6 or 56 Kbps channel ¹	15.00	6.00	5.25	5.00	4.75	FSSFJ	
(c) Multipoint Junction Unit, per 19.2 Kbps channel ¹	15.00	9.45	8.90	8.40	7.90	FSSF9	

2. Subrate Reconfiguration Capability

	Nonrecurring Charge	Month To Month	24 to 48 Months ²	49 to 72 Months ²	73 to 96 Months ²	USOC DSLSB	(N)
(a) Per DS0 equipped (DS0B)	\$45.00					USOC DSLSB	
(b) 9.6 Kbps, per DS0A requires 5	\$5.00	\$8.75	\$8.15	\$7.60	\$7.20	USOC DSLS9	
(c) 4.8 Kbps, per DS0A requires 10	5.00	7.40	6.80	6.30	5.95	USOC DSLS4	

Note 1: Must purchase in units of five.

Note 2: Effective March 23, 2019, Customers may not convert, renew or establish CSPPs for FlexServ Service.

(N)

BELLSOUTH
 TELECOMMUNICATIONS
 FLORIDA
 ISSUED: March 22, 2019
 BY: Joe York, President -FL
 Jacksonville, Florida

ACCESS SERVICES TARIFF

Fourth Revised Page 73
 Cancels Third Revised Page 73

EFFECTIVE: March 23, 2019

E7. DEDICATED ACCESS SERVICES

E7.5 Rates and Charges (Cont'd)

E7.5.16 FlexServ Service (a.k.a. BellSouth SPA Customer Reconfiguration) (Cont'd)

B. FlexServ service (a.k.a. BellSouth SPA Customer Reconfiguration) Options (Cont'd)

2. Subrate Reconfiguration Capability (Cont'd)

		Nonrecurring Charge	Month To Month	24 to 48 Months ¹	49 to 72 Months ¹	73 to 96 Months ¹	USOC	(N)
(d)	2.4 Kbps, per DS0A requires 20	\$5.00	\$7.00	\$6.45	\$5.95	\$5.60	DSL2	
3.	Additional Concurrent User Access						FSSFU	
(a)	Per Additional User Access	125.00	68.00	60.00	57.00	54.00		
4.	Additional User Identification Codes							
(a)	Per Additional Code					Nonrecurring Charge \$3.00	USOC FSSFA	
5.	Additional Customer Training							
(a)	Per eight hour day of training after initial installation					450.00	FSSFT	
6.	Reconfiguration by Company Personnel							
(a)	Request for Company to perform reconfiguration activity					25.00	FSSRA	

E7.5.17 SMARTPath Service (a.k.a. BellSouth SPA Shared Ring)

A. SMARTPath service (a.k.a. BellSouth SPA Shared Ring) Area Connection

1. 1.544 Mbps

		Nonrecurring Charge First	Charge Add'l	Month to Month	Plan A 24 to 48 Months ¹	Plan B 49 to 72 Months ¹	USOC	(N)
(a)	Per SMARTPath service (a.k.a. BellSouth SPA Shared Ring) Area Connection	\$430.00	\$140.00	\$420.00	\$295.00	\$280.00	TMJ1A	

B. SMARTPath service (a.k.a. BellSouth SPA Shared Ring) Area Junction

1. 1.544 Mbps

(a)	Per Customer Designated Premises	430.00	140.00	138.00	90.00	70.00	TMJ1B	
(b)	Per Serving Wire Center Connection	430.00	140.00	70.00	35.00	30.00	TMJ1C	

Note 1: Effective March 23, 2019, Customers may not convert, renew or establish CSPPs for FlexServ Service and may not convert, renew, or establish CSPPs longer than 36 months for SMARTPath Service. (N)

BELLSOUTH
TELECOMMUNICATIONS
FLORIDA

ACCESS SERVICES TARIFF

Fourth Revised Page 74
Cancels Third Revised Page 74

ISSUED: November 30, 2021
BY: Joe York, President -FL
Jacksonville, Florida

EFFECTIVE: December 1, 2021

E7. DEDICATED ACCESS SERVICES

E7.5 Rates and Charges (Cont'd)

E7.5.18 SmartRing[®] service (a.k.a BellSouth Dedicated Ring)

(C)

A. Self-healing Multi-nodal Alternate Route Topology Ring - Month-to-Month

1. Local Channel (All capacities except OC-1)

	Month-to-Month	Nonrecurring Charge	USOC
(a) Per Local Channel	-	\$410.00	1HVXX
(b) Per Quarter Air Mile	\$95.00	-	1HVXX
2. Alternate Central Office (All capacities except OC-1)			
(a) Per Alternate C.O. Channel	-	465.00	1HAXX
(b) Per Quarter Air Mile	1,500.00	-	1HAXX
3. Interoffice Channel (All capacities except OC-1)			
(a) Per Channel, except OC-192 and OC-192+ Capacity	-	155.00	1HXFX
(b) Fixed, OC-3 Capacity	50.00	-	1HXFX
(c) Fixed, OC-3+, OC-12, OC-48 or OC-48+ Capacity	175.00	-	1HXFX
(d) Fixed, OC-192 or OC-192+ Capacity	600.00	300.00	1HXFX
(e) Per Quarter Air Mile, OC-3 Capacity	45.00	-	1HXFX
(f) Per Quarter Air Mile, OC-3+, OC-12, OC-48 or OC-48+ Capacity	55.00	-	1HXFX
(g) Per Quarter Air Mile, OC-192 or OC-192+ Capacity	55.00	-	1HXFX
4. Internodal Channel (All capacities except OC-1)			
(a) Per Internodal Channel, Same Wire Center Area, Per Quarter Air Mile	3,000.00	435.00	1HNXX
(b) Per Internodal Channel, Same Office Park/Campus Environment in Contiguous Serving Wire Center Areas, Per Quarter Air Mile	3,500.00	435.00	1HNZX
5. Customer Node (Per Customer Node)			
(a) OC-1 Capacity	800.00	430.00	SHNC4
(b) OC-3 Capacity	2,200.00	485.00	SHNC3
(c) OC-3+ Capacity	3,000.00	485.00	SHNN5
(d) OC-12 Capacity	3,400.00	485.00	SHNC1
(e) OC-48 Capacity	5,800.00	485.00	SHNN8
(f) OC-48+ Capacity	6,500.00	485.00	SHNN9
(g) OC-192 Capacity	25,000.00	640.00	SHNN6
(h) OC-192+ Capacity	25,000.00	640.00	SHNN2

(M)

Note 1: Effective on or after December 1, 2021, neither new nor existing customers will be permitted to purchase new SMARTRing Service (Service). In addition, (A) Service Payment Plans greater than 12-months in length will no longer be available; and (B) requests to move, add, change, upgrade, or downgrade existing service arrangements will not be accepted, with the following exceptions: (1) existing customers will be permitted to modify their existing Service and will be able to add new circuits to their existing Service, but will not be permitted to add new nodes in any locations; and (2) any such new circuits will be subject to the customer's existing term payment plan or term agreement for the Service to which they are added. Following the expiration of a customer's existing term agreement, Service will be provided on a month-to-month basis at the applicable Month-to-Month rates until the Service is discontinued.

(N)

Effective November 30, 2023, unless specified to the contrary in their existing Service agreements, existing customers may not renew Term Payment Plans or term agreements for Service. In addition, no move, add, or change orders of any type will be accepted.

(N)

BELLSOUTH
TELECOMMUNICATIONS
FLORIDA

ACCESS SERVICES TARIFF

Second Revised Page 74.0.1
Cancels First Revised Page 74.0.1

ISSUED: November 30, 2021
BY: Joe York, President -FL
Jacksonville, Florida

EFFECTIVE: December 1, 2021

E7. SPECIAL ACCESS (A.K.A. BELLSOUTH SPA) SERVICE

E7.5 Rates and Charges (Cont'd)

E7.5.18 SMARTRing² service (a.k.a. BellSouth Dedicated Ring)

(C)

A. Self-healing Multi-nodal Alternate Route Topology Ring - Month-to-Month (Cont'd)

6. Customer Channel Interface (Per Customer Node)

	Month-to-Month	Nonrecurring Charge	USOC	
(a) Per DS1	35.00	240.00	SHNBB	(M)
(b) Per DS3	170.00	110.00	SHNZT	(M)
(c) Per STS-1	220.00	110.00	SHN13	(M)
(d) Per OC-1	100.00	115.00	SHN1C	(M)
(e) Per OC-3, 2-Fiber	240.00	110.00	SHN1D	(M)
(f) Per OC-3, 4-Fiber	475.00	110.00	SHN15	(M)
(g) Per OC-12, 2-Fiber	715.00	115.00	SHN1F	(M)
(h) Per OC-12, 4-Fiber	1,430.00	115.00	SHN19	(M)
(i) Per OC-48, 2-Fiber	1,600.00	640.00	SHN1A	(M)
(j) Per OC-48, 4-Fiber	3,200.00	640.00	SHN1B	(M)
(k) Per 1000 Mbps	740.00	540.00	SHN1K	(M)
(l) Per 100 Mbps (1 STS-1) BellSouth Metro Ethernet ¹ Backbone	500.00	800.00	SHN1J	(M)
(m) Per 100 Mbps (3 STS-1) BellSouth Metro Ethernet ¹ Backbone	540.00	800.00	SHN33	(M)
(n) Per 1000 Mbps BellSouth Metro Ethernet ¹ Backbone	740.00	850.00	SHN34	(M)
(o) Per Fractional 1000 Mbps Metro Ethernet ¹ Backbone				
- 150 Mbps (3 STS-1)	\$560.00	\$850.00	SHN35	
- 300 Mbps (6 STS-1)	600.00	850.00	SHN36	
- 450 Mbps (9 STS-1)	640.00	850.00	SHN37	
- 600 Mbps (12 STS-1)	700.00	850.00	SHN38	

Note 1: Effective on or after August 22, 2021, this Service will no longer be available for purchase by new or existing customers. In addition, requests to move, add, change, or renew existing service arrangements will not be accepted. Following the expiration of a customer's existing term agreement, service will be provided on a month-to-month basis at the applicable Monthly rates until the service is discontinued. The Company currently plans to discontinue this service on or after March 31, 2023.

Note 2: Effective on or after December 1, 2021, neither new nor existing customers will be permitted to purchase new SMARTRing Service (Service). In addition, (A) Service Payment Plans greater than 12-months in length will no longer be available; and (B) requests to move, add, change, upgrade, or downgrade existing service arrangements will not be accepted, with the following exceptions: (1) existing customers will be permitted to modify their existing Service and will be able to add new circuits to their existing Service, but will not be permitted to add new nodes in any locations; and (2) any such new circuits will be subject to the customer's existing term payment plan or term agreement for the Service to which they are added. Following the expiration of a customer's existing term agreement, Service will be provided on a month-to-month basis at the applicable Month-to-Month rates until the Service is discontinued.

(N)

Effective November 30, 2023, unless specified to the contrary in their existing Service agreements, existing customers may not renew Term Payment Plans or term agreements for Service. In addition, no move, add, or change orders of any type will be accepted.

(N)

BELLSOUTH
TELECOMMUNICATIONS
FLORIDA

ACCESS SERVICES TARIFF

Second Revised Page 74.1
Cancels First Revised Page 74.1

ISSUED: November 30, 2021
BY: Joe York, President -FL
Jacksonville, Florida

EFFECTIVE: December 1, 2021

E7. DEDICATED ACCESS SERVICES**E7.5 Rates and Charges (Cont'd)****E7.5.18 SMARTRing¹ service (a.k.a. BellSouth Dedicated Ring) (Cont'd)**

(C)

A. Self-healing Multi-nodal Alternate Route Topology Ring - Month-to-Month (Cont'd)

		Month-to- Month	Nonrecurring Charge	USOC
7.	Central Office Node (Per Central Office Node)			
	(a) OC-1 Capacity	\$600.00	\$425.00	SHNH4
	(b) OC-3 Capacity	1,400.00	485.00	SHNH3
	(c) OC-3+ Capacity	2,500.00	485.00	SHNH5
	(d) OC-12 Capacity	2,600.00	485.00	SHNH1
	(e) OC-48 Capacity	5,400.00	485.00	SHNH8
	(f) OC-48+ Capacity	6,100.00	485.00	SHNH9
	(g) OC-192 Capacity	25,000.00	640.00	SHNH7
	(h) OC-192+ Capacity	25,000.00	640.00	SHNH6
	(i) OC-3 Shared Node Interconnection	980.00	550.00	SHNHE
	(j) OC-12 Shared Node Interconnection	1,820.00	550.00	SHNHE
	(k) OC-48 Shared Node Interconnection	3,400.00	550.00	SHNHE
	(l) OC-48+ Shared Node Interconnection	3,840.00	550.00	SHNHE

Note 1: Effective on or after December 1, 2021, neither new nor existing customers will be permitted to purchase new SMARTRing Service (Service). In addition, (A) Service Payment Plans greater than 12-months in length will no longer be available; and (B) requests to move, add, change, upgrade, or downgrade existing service arrangements will not be accepted, with the following exceptions: (1) existing customers will be permitted to modify their existing Service and will be able to add new circuits to their existing Service, but will not be permitted to add new nodes in any locations; and (2) any such new circuits will be subject to the customer's existing term payment plan or term agreement for the Service to which they are added. Following the expiration of a customer's existing term agreement, Service will be provided on a month-to-month basis at the applicable Month-to-Month rates until the Service is discontinued.

(N)

Effective November 30, 2023, unless specified to the contrary in their existing Service agreements, existing customers may not renew Term Payment Plans or term agreements for Service. In addition, no move, add, or change orders of any type will be accepted.

(N)

BELLSOUTH
TELECOMMUNICATIONS
FLORIDA

ACCESS SERVICES TARIFF

Fifth Revised Page 75
Cancels Fourth Revised Page 75

ISSUED: November 30, 2021
BY: Joe York, President -FL
Jacksonville, Florida

EFFECTIVE: December 1, 2021

E7. DEDICATED ACCESS SERVICES

E7.5 Rates and Charges (Cont'd)

E7.5.18 SMARTRing² service (a.k.a BellSouth Dedicated Ring)

(C)

- A. Self-healing Multi-nodal Alternate Route Topology Ring - Month-to-Month
8. Central Office Channel Interface (Per Central Office Node)

	Month-to-Month	Nonrecurring Charge	USOC
(a) Per DS1	\$35.00	\$100.00	SHNCB
(b) Per DS3	115.00	155.00	SHNYT
(c) Per STS-1	150.00	160.00	SHNO2
(d) Per OC-1	100.00	170.00	SHNCC
(e) Per OC-3, 2-Fiber	240.00	105.00	SHNCD
(f) Per OC-3, 4-Fiber	425.00	105.00	SHNO4
(g) Per OC-12, 2-Fiber	640.00	105.00	SHNCF
(h) Per OC-12, 4-Fiber	1,280.00	105.00	SHNC9
(i) Per OC-48, 2-Fiber	1,600.00	640.00	SHNCJ
(j) Per OC-48, 4-Fiber	3,200.00	640.00	SHNCK
(k) Per 28 DS1 Channel System - DS3	650.00	130.00	SHNW8
(l) Per 28 DS1 Channel System - STS-1	750.00	130.00	SHNCS
(m) Per DS1 on 28 DS1 Channel System - DS3	12.00	130.00	SHNCA
(n) Per DS1 on 28 DS1 Channel System - STS-1	40.00	82.00	SHNCG
(o) Per 1000 Mbps	740.00	400.00	SHNCW
(p) Per 100 Mbps (1 STS-1) BellSouth Metro Ethernet ¹ Backbone	500.00	800.00	SHNOJ
(q) Per 100 Mbps (3 STS-1) BellSouth Metro Ethernet ¹ Backbone	540.00	800.00	SHNCX
(r) Per 1000 Mbps BellSouth Metro Ethernet ¹ Backbone	740.00	850.00	SHNC5
(s) Per Fractional 1000 Mbps Metro Ethernet ¹ Backbone			
- 150 Mbps (3 STS-1)	560.00	850.00	SHND5
- 300 Mbps (6 STS-1)	600.00	850.00	SHND6
- 450 Mbps (9 STS-1)	640.00	850.00	SHND7
- 600 Mbps (12 STS-1)	700.00	850.00	SHND8

Note 1: Effective on or after August 22, 2021, this Service will no longer be available for purchase by new or existing customers. In addition, requests to move, add, change, or renew existing service arrangements will not be accepted. Following the expiration of a customer's existing term agreement, service will be provided on a month-to-month basis at the applicable Monthly rates until the service is discontinued. The Company currently plans to discontinue this service on or after March 31, 2023.

Note 2: Effective on or after December 1, 2021, neither new nor existing customers will be permitted to purchase new SMARTRing Service (Service). In addition, (A) Service Payment Plans greater than 12-months in length will no longer be available; and (B) requests to move, add, change, upgrade, or downgrade existing service arrangements will not be accepted, with the following exceptions: (1) existing customers will be permitted to modify their existing Service and will be able to add new circuits to their existing Service, but will not be permitted to add new nodes in any locations; and (2) any such new circuits will be subject to the customer's existing term payment plan or term agreement for the Service to which they are added. Following the expiration of a customer's existing term agreement, Service will be provided on a month-to-month basis at the applicable Month-to-Month rates until the Service is discontinued.

(N)

Effective November 30, 2023, unless specified to the contrary in their existing Service agreements, existing customers may not renew Term Payment Plans or term agreements for Service. In addition, no move, add, or change orders of any type will be accepted.

(N)

BELLSOUTH
TELECOMMUNICATIONS
FLORIDA

ACCESS SERVICES TARIFF

First Revised Page 75.1
Cancels Original Page 75.1

ISSUED: November 30, 2021
BY: Joe York, President -FL
Jacksonville, Florida

EFFECTIVE: December 1, 2021

E7. DEDICATED ACCESS SERVICES**E7.5 Rates and Charges (Cont'd)****E7.5.18 SmartRing^l service (a.k.a BellSouth Dedicated Ring)****B. Self-healing Multi-nodal Alternate Route Topology Ring - Transport Payment Plan**

1. Local Channel (All capacities except OC-1)

		Per Month Rates			
		A	B	C	
		12-36	37-60	61-96	USOC
		Months ^l	Months ^l	Months ^l	
	(a) Per Quarter Air Mile	\$85.00	\$75.00	\$70.00	1HVXX
2.	Alternate Central Office (All capacities except OC-1)				
	(a) Per Quarter Air Mile	400.00	250.00	200.00	1HAXX
3.	Interoffice Channel (All capacities except OC-1)				
	(a) Fixed, OC-3 Capacity	40.00	35.00	30.00	1HXFX
	(b) Fixed, OC-3+, OC-12, OC-48 or OC-48+ Capacity	155.00	140.00	130.00	1HXFX
	(c) Fixed, OC-192 or OC-192+ Capacity	450.00	400.00	380.00	1HXFX
	(d) Per Quarter Air Mile, OC-3 Capacity	35.00	25.00	20.00	1HXFX
	(e) Per Quarter Air Mile, OC-3+, OC-12, OC-48 or OC-48+ Capacity	40.00	33.00	25.00	1HXFX
	(f) Per Quarter Air Mile, OC-192 or OC-192+ Capacity	40.00	33.00	25.00	1HXFX
4.	Internodal Channel (All capacities except OC-1)				
	(a) Per Internodal Channel, Same Wire Center Area, Per Quarter Air Mile	690.00	415.00	345.00	1HNXX
	(b) Per Internodal Channel, Same Office Park/Campus Environment in Contiguous Serving Wire Center Areas, Per Quarter Air Mile	780.00	465.00	390.00	1HNZX
5.	Customer Node (Per Customer Node)				
	(a) OC-1 Capacity	400.00	350.00	300.00	SHNC4
	(b) OC-3 Capacity	1,100.00	1,000.00	900.00	SHNC3
	(c) OC-3+ Capacity	2,050.00	1,750.00	1,500.00	SHNN5
	(d) OC-12 Capacity	2,200.00	2,000.00	1,750.00	SHNC1
	(e) OC-48 Capacity	4,900.00	4,500.00	3,900.00	SHNN8
	(f) OC-48+ Capacity	4,900.00	4,500.00	3,900.00	SHNN9
	(g) OC-192 Capacity	9,375.00	8,250.00	7,300.00	SHNN6
	(h) OC-192+ Capacity	9,375.00	8,250.00	7,300.00	SHNN2

Note 1: Effective on or after December 1, 2021, neither new nor existing customers will be permitted to purchase new SMARTRing Service (Service). In addition, (A) Service Payment Plans greater than 12-months in length will no longer be available; and (B) requests to move, add, change, upgrade, or downgrade existing service arrangements will not be accepted, with the following exceptions: (1) existing customers will be permitted to modify their existing Service and will be able to add new circuits to their existing Service, but will not be permitted to add new nodes in any locations; and (2) any such new circuits will be subject to the customer's existing term payment plan or term agreement for the Service to which they are added. Following the expiration of a customer's existing term agreement, Service will be provided on a month-to-month basis at the applicable Month-to-Month rates until the Service is discontinued.

Effective November 30, 2023, unless specified to the contrary in their existing Service agreements, existing customers may not renew Term Payment Plans or term agreements for Service. In addition, no move, add, or change orders of any type will be accepted.

BELLSOUTH
TELECOMMUNICATIONS
FLORIDA

ACCESS SERVICES TARIFF

Fifth Revised Page 76
Cancels Fourth Revised Page 76

ISSUED: November 30, 2021
BY: Joe York, President -FL
Jacksonville, Florida

EFFECTIVE: December 1, 2021

E7. DEDICATED ACCESS SERVICES

E7.5 Rates and Charges (Cont'd)

E7.5.18 SMARTRing² service (a.k.a BellSouth Dedicated Ring)

- B. Self-healing Multi-nodal Alternate Route Topology Ring - Transport Payment Plan (Cont'd)
- 6. Customer Channel Interface (Per Customer Node)

		Per Month Rates			
		A	B	C	
		12-36	37-60	61-96	
		Months ²	Months ²	Months ²	USOC
(a)	Per DS1	\$34.00	\$27.00	\$21.00	SHNBB
(b)	Per DS3	135.00	130.00	125.00	SHNZT
(c)	Per STS-1	170.00	150.00	140.00	SHN13
(d)	Per OC-1	90.00	80.00	75.00	SHN1C
(e)	Per OC-3, 2-Fiber	190.00	175.00	160.00	SHN1D
(f)	Per OC-3, 4-Fiber	380.00	350.00	320.00	SHN15
(g)	Per OC-12, 2-Fiber	570.00	525.00	480.00	SHN1F
(h)	Per OC-12, 4-Fiber	1,140.00	1,050.00	960.00	SHN19
(i)	Per OC-48, 2-Fiber	1,325.00	1,215.00	1,050.00	SHN1A
(j)	Per OC-48, 4-Fiber	2,650.00	2,430.00	2,100.00	SHN1B
(k)	Per 1000 Mbps	520.00	475.00	425.00	SHN1K
(l)	Per 100 Mbps (1 STS-1) BellSouth Metro Ethernet ¹ Backbone	175.00	155.00	140.00	SHN1J
(m)	Per 100 Mbps (3 STS-1) BellSouth Metro Ethernet ¹ Backbone	210.00	190.00	170.00	SHN33
(n)	Per 1000 Mbps BellSouth Metro Ethernet ¹ Backbone	520.00	475.00	425.00	SHN34
(o)	Per Fractional 1000 Mbps Metro Ethernet ¹ Backbone				
	- 150 Mbps (3 STS-1)	230.00	210.00	190.00	SHN35
	- 300 Mbps (3 STS-1)	300.00	280.00	260.00	SHN36
	- 450 Mbps (3 STS-1)	340.00	310.00	290.00	SHN37
	- 650 Mbps (3 STS-1)	380.00	340.00	320.00	SHN38
7.	Central Office Node (Per Central Office Node)				
(a)	OC-1 Capacity	400.00	350.00	300.00	SHNH4
(b)	OC-3 Capacity	1,100.00	1,000.00	900.00	SHNH3
(c)	OC-3+ Capacity	2,050.00	1,750.00	1,500.00	SHNH5
(d)	OC-12 Capacity	2,200.00	2,000.00	1,750.00	SHNH1
(e)	OC-48 Capacity	4,900.00	4,500.00	3,900.00	SHNH8
(f)	OC-48+ Capacity	4,900.00	4,500.00	3,900.00	SHNH9
(g)	OC-192 Capacity	9,375.00	8,250.00	7,300.00	SHNH7
(h)	OC-192+ Capacity	9,375.00	8,250.00	7,300.00	SHNH6
(i)	OC-3 Shared Node Interconnection	690.00	630.00	570.00	SHNHE
(j)	OC-12 Shared Node Interconnection	1,390.00	1,260.00	1,100.00	SHNHE
(k)	OC-48 Shared Node Interconnection	2,880.00	2,840.00	2,460.00	SHNHE
(l)	OC-48+ Shared Node Interconnection	2,880.00	2,840.00	2,460.00	SHNHE

Note 1: Effective on or after August 22, 2021, this Service will no longer be available for purchase by new or existing customers. In addition, requests to move, add, change, or renew existing service arrangements will not be accepted. Following the expiration of a customer's existing term agreement, service will be provided on a month-to-month basis at the applicable Monthly rates until the service is discontinued. The Company currently plans to discontinue this service on or after March 31, 2023.

Note 2: Effective on or after December 1, 2021, neither new nor existing customers will be permitted to purchase new SMARTRing Service (Service). In addition, (A) Service Payment Plans greater than 12-months in length will no longer be available; and (B) requests to move, add, change, upgrade, or downgrade existing service arrangements will not be accepted, with the following exceptions: (1) existing customers will be permitted to modify their existing Service and will be able to add new circuits to their existing Service, but will not be permitted to add new nodes in any locations; and (2) any such new circuits will be subject to the customer's existing term payment plan or term agreement for the Service to which they are added. Following the expiration of a customer's existing term agreement, Service will be provided on a month-to-month basis at the applicable Month-to-Month rates until the Service is discontinued.

Effective November 30, 2023, unless specified to the contrary in their existing Service agreements, existing customers may not renew Term Payment Plans or term agreements for Service. In addition, no move, add, or change orders of any type will be accepted.

BELLSOUTH
TELECOMMUNICATIONS
FLORIDA

ACCESS SERVICES TARIFF

Second Revised Page 76.1
Cancels First Revised Page 76.1

ISSUED: November 30, 2021
BY: Joe York, President -FL
Jacksonville, Florida

EFFECTIVE: December 1, 2021

E7. DEDICATED ACCESS SERVICES

E7.5 Rates and Charges (Cont'd)

E7.5.18 SMARTRing¹ service (a.k.a BellSouth Dedicated Ring)

B. Self-healing Multi-nodal Alternate Route Topology Ring - Transport Payment Plan (Cont'd)

8. Central Office Channel Interface (Per Central Office Node)

		Per Month Rates			
		A	B	C	
		12-36	37-60	61-96	
		Months ¹	Months ¹	Months ¹	USOC
(a)	Per DS1	\$30.00	\$25.00	\$20.00	SHNCB
(b)	Per DS3	85.00	80.00	75.00	SHNYT
(c)	Per STS-1	105.00	100.00	90.00	SHNO2
(d)	Per OC-1	90.00	80.00	75.00	SHNCC
(e)	Per OC-3, 2-Fiber	190.00	175.00	160.00	SHNCD
(f)	Per OC-3, 4-Fiber	330.00	300.00	270.00	SHNO4
(g)	Per OC-12, 2-Fiber	495.00	450.00	405.00	SHNCF
(h)	Per OC-12, 4-Fiber	990.00	900.00	810.00	SHNC9
(i)	Per OC-48, 2-Fiber	1,325.00	1,215.00	1,050.00	SHNCJ
(j)	Per OC-48, 4-Fiber	2,650.00	2,430.00	2,100.00	SHNCK
(k)	Per 28 DS1 Channel System - DS3	550.00	500.00	450.00	SHNW8
(l)	Per 28 DS1 Channel System - STS-1	650.00	600.00	575.00	SHNCS
(m)	Per DS1 on 28 DS1 Channel System - DS3	12.00	9.00	7.00	SHNCA
(n)	Per DS1 on 28 DS1 Channel System - STS-1	35.00	30.00	25.00	SHNCG
(o)	Per 1000 Mbps	520.00	475.00	425.00	SHNCW
(p)	Per 100 Mbps (1 STS-1) BellSouth Metro Ethernet Backbone	175.00	155.00	140.00	SHNOJ
(q)	Per 100 Mbps (3 STS-1) BellSouth Metro Ethernet Backbone	210.00	190.00	170.00	SHNCX
(r)	Per 1000 Mbps BellSouth Metro Ethernet Backbone	520.00	475.00	425.00	SHNC5
(s)	Per Fractional 1000 Mbps Metro Ethernet Backbone				
	- 150 Mbps (3 STS-1)	230.00	210.00	190.00	SHND5
	- 300 Mbps (6 STS-1)	300.00	280.00	260.00	SHND6
	- 450 Mbps (9 STS-1)	340.00	310.00	290.00	SHND7
	- 600 Mbps (12 STS-1)	380.00	340.00	320.00	SHND8

C. Self-healing Multi-nodal Alternate Route Topology Ring

1. Channel Interface Reallocation

		Nonrecurring Charge	USOC
(a)	Per Node, Per Occurrence	\$250.00	SHRBC

Note 1: Effective on or after December 1, 2021, neither new nor existing customers will be permitted to purchase new SMARTRing Service (Service). In addition, (A) Service Payment Plans greater than 12-months in length will no longer be available; and (B) requests to move, add, change, upgrade, or downgrade existing service arrangements will not be accepted, with the following exceptions: (1) existing customers will be permitted to modify their existing Service and will be able to add new circuits to their existing Service, but will not be permitted to add new nodes in any locations; and (2) any such new circuits will be subject to the customer's existing term payment plan or term agreement for the Service to which they are added. Following the expiration of a customer's existing term agreement, Service will be provided on a month-to-month basis at the applicable Month-to-Month rates until the Service is discontinued.

Effective November 30, 2023, unless specified to the contrary in their existing Service agreements, existing customers may not renew Term Payment Plans or term agreements for Service. In addition, no move, add, or change orders of any type will be accepted.

BELLSOUTH
TELECOMMUNICATIONS
FLORIDA
ISSUED: October 10, 2014
BY: Joe York, President -FL
Jacksonville, Florida

ACCESS SERVICES TARIFF

First Revised Page 77
Cancels Original Page 77

EFFECTIVE: October 11, 2014

E7. DEDICATED ACCESS SERVICES

E7.5 Rates and Charges (Cont'd)

E7.5.19 Reserved for Future Use

(T)

(D)

BELLSOUTH
TELECOMMUNICATIONS
FLORIDA

ACCESS SERVICES TARIFF

Fifth Revised Page 78
Cancels Fourth Revised Page 78

ISSUED: June 14, 2023
BY: Joe York, President -FL
Jacksonville, Florida

EFFECTIVE: June 15, 2023

E7. SPECIAL ACCESS (A.K.A. BELLSOUTH SPA) SERVICE**E7.5 Rates and Charges (Cont'd)****E7.5.20 Reserved For Future Use****E7.5.21 Reserved For Future Use****E7.5.22 BellSouth Metro Ethernet Service¹****A. Rates and charges for month-to-month service****1. Basic BellSouth Metro Ethernet Service Arrangements****(a) 2 Mbps Basic Connection**

- Per Connection

Nonrecurring Charge	Month to Month	USOC
\$ 950.00	\$ 668.25	MTEBO

(b) 4 Mbps Basic Connection

- Per Connection

950.00	695.25	MTEB1
--------	--------	-------

(c) 8 Mbps Basic Connection

- Per Connection

950.00	810.00	MTEB2
--------	--------	-------

(d) 10 Mbps Basic Connection

- Per Connection

900.00	918.00	MTEBA
--------	--------	-------

(e) 100 Mbps Basic Connection

- Per Connection

900.00	1,768.50	MTEBB
--------	----------	-------

(f) 1 Gbps Basic Connection

- Per Connection

1,000.00	3,847.50	MTEBC
----------	----------	-------

2. Premium BellSouth Metro Ethernet Service Arrangements**(a) 2 Mbps Premium Connection**

- Per Connection, Fixed Mode

950.00	739.80	MTEPO
--------	--------	-------

(b) 4 Mbps Premium Connection

- Per Connection, Fixed Mode

950.00	777.60	MTEP1
--------	--------	-------

(c) 8 Mbps Premium Connection

- Per Connection, Fixed Mode

950.00	896.40	MTEP2
--------	--------	-------

(d) 10 Mbps Premium Connection

- Per Connection, Fixed Mode

900.00	1,220.40	MTEP3
--------	----------	-------

- Per Connection, Burst Mode

900.00	1,529.55	MTEE3
--------	----------	-------

(e) 20 Mbps Premium Connection

- Per Connection, Fixed Mode

900.00	1,522.80	MTEP4
--------	----------	-------

- Per Connection, Burst Mode

900.00	1,711.80	MTEE4
--------	----------	-------

(f) 50 Mbps Premium Connection

- Per Connection, Fixed Mode

900.00	2,008.80	MTEP5
--------	----------	-------

- Per Connection, Burst Mode

900.00	2,085.75	MTEE5
--------	----------	-------

(g) 100 Mbps Premium Connection

- Per Connection, Fixed Mode

1,000.00	2,430.00	MTEP6
----------	----------	-------

- Per Connection, Burst Mode

1,000.00	2,724.30	MTEE6
----------	----------	-------

(h) 250 Mbps Premium Connection

- Per Connection, Fixed Mode

1,000.00	3,034.80	MTEP7
----------	----------	-------

- Per Connection, Burst Mode

1,000.00	3,260.25	MTEE7
----------	----------	-------

(i) 500 Mbps Premium Connection

- Per Connection, Fixed Mode

1,000.00	4,039.20	MTEP8
----------	----------	-------

- Per Connection, Burst Mode

1,000.00	4,182.30	MTEE8
----------	----------	-------

(j) 900 Mbps Premium Connection

- Per Connection, Fixed Mode

1,500.00	5,988.60	MTEP9
----------	----------	-------

3.

Note 1: Effective on or after August 22, 2021, this Service will no longer be available for purchase by new or existing customers. In addition, requests to move, add, change, or renew existing service arrangements will not be accepted. Following the expiration of a customer's existing term agreement, service will be provided on a month-to-month basis at the applicable Monthly rates until the service is discontinued. The Company currently plans to discontinue this service on or after March 31, 2023.

(1)

(1)

BELLSOUTH
 TELECOMMUNICATIONS
 FLORIDA
 ISSUED: June 14, 2023
 BY: Joe York, President -FL
 Jacksonville, Florida

ACCESS SERVICES TARIFF

Fourth Revised Page 78.1
 Cancels Third Revised Page 78.1

EFFECTIVE: June 15, 2023

E7. SPECIAL ACCESS (A.K.A. BELLSOUTH SPA) SERVICE

E7.5 Rates and Charges (Cont'd)

E7.5.22 BellSouth Metro Ethernet Service (Cont'd)²

A. Rates and charges for month-to-month service (Cont'd)

4. Virtual BellSouth Metro Ethernet Service Arrangements¹

(a) 2 Mbps Virtual Connection

	Nonrecurring Charge	Month to Month	USOC
- Per Connection	\$ 1,000.00	\$ 523.80	MTEVO
(b) 4 Mbps Virtual Connection - Per Connection	1,000.00	561.60	MTEV1
(c) 8 Mbps Virtual Connection - Per Connection	1,000.00	680.40	MTEV2
(d) 10 Mbps Virtual Connection - Per Connection	1,000.00	1,004.40	MTEV3
(e) 20 Mbps Virtual Connection - Per Connection	1,000.00	1,306.80	MTEV4
(f) 50 Mbps Virtual Connection - Per Connection	1,000.00	1,792.80	MTEV5
(g) 80 Mbps Virtual Connection - Per Connection	1,000.00	2,003.40	MTEV6
(h) 100 Mbps Virtual Connection - Per Connection	1,500.00	2,214.00	MTEV7
(i) 200 Mbps Virtual Connection - Per Connection	1,500.00	2,818.80	MTEV8
(j) 300 Mbps Virtual Connection - Per Connection	1,500.00	3,180.60	MTEV9
(k) 450 Mbps Virtual Connection - Per Connection	1,500.00	3,823.20	MTEVA
(l) 600 Mbps Virtual Connection - Per Connection	1,750.00	4,541.40	MTEVB
(m) 750 Mbps Virtual Connection - Per Connection	1,750.00	5,292.00	MTEVC
(n) 900 Mbps Virtual Connection - Per Connection	2,000.00	5,772.60	MTEVD

(1)

5. BellSouth Metro Ethernet Service Independent Company (ICO) Trunk Arrangements

**(a) ICO Trunk Connection
- Per VLAN Connection**

1,300.00	1,046.25	MTEGC
----------	----------	-------

(1)

Note 1: Each Virtual Connection requires the establishment of a Class of Service (CoS) profile.

Note 2: Effective on or after August 22, 2021, this Service will no longer be available for purchase by new or existing customers. In addition, requests to move, add, change, or renew existing service arrangements will not be accepted. Following the expiration of a customer's existing term agreement, service will be provided on a month-to-month basis at the applicable Monthly rates until the service is discontinued. The Company currently plans to discontinue this service on or after March 31, 2023.

BELLSOUTH
 TELECOMMUNICATIONS
 FLORIDA
 ISSUED: June 14, 2023
 BY: Joe York, President -FL
 Jacksonville, Florida

ACCESS SERVICES TARIFF

Seventh Revised Page 79
 Cancels Sixth Revised Page 79

EFFECTIVE: June 15, 2023

E7. SPECIAL ACCESS (A.K.A. BELLSOUTH SPA) SERVICE

E7.5 Rates and Charges (Cont'd)

E7.5.22 BellSouth Metro Ethernet Service (Cont'd)¹

A. Rates and charges for month-to-month service (Cont'd)

6. BellSouth Metro Ethernet Service Additional Mileage

- (a) BellSouth Metro Ethernet Service Additional Mileage:
 BellSouth Metro Ethernet Service arrangements greater than
 10 miles through 25 airline miles

	Month to Month	USOC
- Per 2 – 9 Mbps Connection	\$ 432.00	MTEMO
- Per 10 – 99 Mbps Connection	449.55	MTEMA
- Per 100 – 499 Mbps Connection	558.90	MTEMB
- Per 500 Mbps – 1 Gbps Connection	680.40	MTEMC

- (b) BellSouth Metro Ethernet Service Additional Mileage:
 BellSouth Metro Ethernet Service arrangements greater than
 25 miles through 35 airline miles

- Per 2 – 9 Mbps Connection	708.75	MTEMD
- Per 10 – 99 Mbps Connection	753.30	MTEME
- Per 100 – 499 Mbps Connection	947.70	MTEMF
- Per 500 Mbps – 1 Gbps Connection	1,129.95	MTEMG

- (c) BellSouth Metro Ethernet Service Additional Mileage:
 BellSouth Metro Ethernet Service arrangements greater than
 35 miles through 50 airline miles

- Per 2 – 9 Mbps Connection	1,080.00	MTEMH
- Per 10 – 99 Mbps Connection	1,178.55	MTEMJ
- Per 100 – 499 Mbps Connection	1,470.15	MTEMK
- Per 500 Mbps – 1 Gbps Connection	1,773.90	MTEML

7. BellSouth Metro Ethernet Service Independent Company (ICO) Trunk Additional Mileage Charges

- (a) BellSouth Metro Ethernet Service ICO Trunk Additional Mileage:
 BellSouth Metro Ethernet Service ICO Trunk arrangements greater than
 10 miles through 25 airline miles
 - per VLAN Connection

229.50 MTEM1

(1)

- (b) BellSouth Metro Ethernet Service ICO Trunk Additional Mileage:
 BellSouth Metro Ethernet Service ICO Trunk arrangements greater than
 25 miles through 35 airline miles
 - per VLAN Connection

567.00 MTEM2

(1)

- (c) BellSouth Metro Ethernet Service ICO Trunk Additional Mileage:
 BellSouth Metro Ethernet Service ICO Trunk arrangements greater than
 35 miles through 50 airline miles
 - per VLAN Connection

911.25 MTEM3

(1)

Note 1: Effective on or after August 22, 2021, this Service will no longer be available for purchase by new or existing customers. In addition, requests to move, add, change, or renew existing service arrangements will not be accepted. Following the expiration of a customer's existing term agreement, service will be provided on a month-to-month basis at the applicable Monthly rates until the service is discontinued. The Company currently plans to discontinue this service on or after March 31, 2023.

BELLSOUTH
TELECOMMUNICATIONS
FLORIDA
ISSUED: June 14, 2023
BY: Joe York, President -FL
Jacksonville, Florida

ACCESS SERVICES TARIFF

Sixth Revised Page 80
Cancels Fifth Revised Page 80

EFFECTIVE: June 15, 2023

E7. SPECIAL ACCESS (A.K.A. BELLSOUTH SPA) SERVICE**E7.5 Rates and Charges (Cont'd)****E7.5.22 BellSouth Metro Ethernet Service (Cont'd)⁴****A. Rates and charges for month-to-month service (Cont'd)****8. Priority Plus Feature¹**

	Nonrecurring Charge	Month to Month	USOC	
- Per Connection	\$ -	\$ 162.00	MTEQP	(1)
9. Q-Forwarding Feature¹				
(a) Q-Forwarding Service Establishment Charge - Per Connection	400.00	-	MTEQF	
(b) Q-Forwarding Network Assignment Charge - Per Network, Per Connection	-	108.00	MTEQN	(1)
10. VLAN Aggregation Feature²				
(a) VLAN Aggregation Service Establishment Charge - Per Connection	400.00	-	MTEQE	
(b) VLAN Aggregation Network Assignment Charge - Per VLAN, Per Connection	-	108.00	MTEQV	(1)
11. CNM - Metro Ethernet Reporting Feature³				
(a) CNM - Metro Ethernet Reporting, Service Establishment Charge - Per Customer Account	225.00	-	MTERE	
(b) CNM - Metro Ethernet Reporting Charge - Per Connection	-	13.50	MTERC	(1)
(c) CNM - Metro Ethernet Reporting, Web Interface Charge - First	-	-	MTER1	
- Each Additional	65.00	27.00	MTERW	(1)
(d) CNM - Metro Ethernet Reporting, Security Card - Each	200.00	-	MTERS	

Note 1: Optional feature only available with a Premium Connection.

Note 2: Optional feature only available with a Virtual Connection.

Note 3: Optional feature only available with a Premium or Virtual Connection.

Note 4: Effective on or after August 22, 2021, this Service will no longer be available for purchase by new or existing customers. In addition, requests to move, add, change, or renew existing service arrangements will not be accepted. Following the expiration of a customer's existing term agreement, service will be provided on a month-to-month basis at the applicable Monthly rates until the service is discontinued. The Company currently plans to discontinue this service on or after March 31, 2023.

BELLSOUTH
 TELECOMMUNICATIONS
 FLORIDA
 ISSUED: June 14, 2023
 BY: Joe York, President -FL
 Jacksonville, Florida

ACCESS SERVICES TARIFF

Third Revised Page 80.0.1
 Cancels Second Revised Page 80.0.1

EFFECTIVE: June 15, 2023

E7. SPECIAL ACCESS (A.K.A. BELLSOUTH SPA) SERVICE

E7.5 Rates and Charges (Cont'd)

E7.5.22 BellSouth Metro Ethernet Service (Cont'd)³

A. Rates and charges for month-to-month service (Cont'd)

12. Class of Service (CoS) Profile¹

(a) Real-Time CoS²

	Month to Month	USOC
- 10%	\$ 72.90	MTETF
- 20%	145.80	MTETG
- 25%	182.25	MTETH
- 30%	218.70	MTETJ
- 35%	255.15	MTETK
- 40%	291.60	MTETL
- 50%	364.50	MTETM
- 70%	510.30	MTETO

(b) Interactive CoS²

- 10%	60.75	MTEVF
- 20%	121.50	MTEVG
- 25%	151.20	MTEVH
- 30%	182.25	MTEVJ
- 35%	211.95	MTEVK
- 40%	243.00	MTEVL
- 50%	303.75	MTEVM

Note 1: Each Virtual Connection requires the designation of a CoS profile with desired percentages of each CoS selected. The sum of the percentages for all CoS selected for a Virtual Connection must sum to 100%.

Note 2: The combined CoS bandwidth percentages selected in a customer's Virtual Connection CoS profile for Real-Time CoS plus Interactive CoS may not exceed 50%, except where the customer selects the 70% Real-Time CoS bandwidth percentage and has no Interactive traffic.

Note 3: Effective on or after August 22, 2021, this Service will no longer be available for purchase by new or existing customers. In addition, requests to move, add, change, or renew existing service arrangements will not be accepted. Following the expiration of a customer's existing term agreement, service will be provided on a month-to-month basis at the applicable Monthly rates until the service is discontinued. The Company currently plans to discontinue this service on or after March 31, 2023.

(1)

BELLSOUTH
 TELECOMMUNICATIONS
 FLORIDA
 ISSUED: June 14, 2023
 BY: Joe York, President -FL
 Jacksonville, Florida

ACCESS SERVICES TARIFF

Third Revised Page 80.0.2
 Cancels Second Revised Page 80.0.2

EFFECTIVE: June 15, 2023

E7. SPECIAL ACCESS (A.K.A. BELLSOUTH SPA) SERVICE

E7.5 Rates and Charges (Cont'd)

E7.5.22 BellSouth Metro Ethernet Service (Cont'd)²

A. Rates and charges for month-to-month service (Cont'd)

12. Class of Service (CoS) Profile¹ (Cont'd)

(c) Business Critical CoS

	Month to Month	USOC
- 10%	\$ 36.45	MTEPF
- 20%	72.90	MTEPG
- 25%	90.45	MTEPH
- 30%	109.35	MTEPJ
- 35%	126.90	MTEPK
- 40%	145.80	MTEPL
- 50%	182.25	MTEPM
- 60%	218.70	MTEPN
- 75%	272.70	MTEPP
- 90%	328.05	MTEPQ
- 100%	364.50	MTEPR

(d) Best Effort CoS

- 10%	12.15	MTEBF
- 20%	24.30	MTEBG
- 25%	29.70	MTEBH
- 30%	36.45	MTEBJ
- 35%	41.85	MTEBK
- 40%	48.60	MTEBL
- 50%	60.75	MTEBM
- 60%	72.90	MTEBN
- 75%	90.45	MTEBP
- 90%	109.35	MTEBQ

Note 1: Each Virtual Connection requires the designation of a CoS profile with desired percentages of each CoS selected. The sum of the percentages for all CoS selected for a Virtual Connection must sum to 100%.

Note 2: Effective on or after August 22, 2021, this Service will no longer be available for purchase by new or existing customers. In addition, requests to move, add, change, or renew existing service arrangements will not be accepted. Following the expiration of a customer's existing term agreement, service will be provided on a month-to-month basis at the applicable Monthly rates until the service is discontinued. The Company currently plans to discontinue this service on or after March 31, 2023.

(1)

BELLSOUTH
 TELECOMMUNICATIONS
 FLORIDA
 ISSUED: June 14, 2023
 BY: Joe York, President -FL
 Jacksonville, Florida

ACCESS SERVICES TARIFF

Fifth Revised Page 80.1
 Cancels Fourth Revised Page 80.1

EFFECTIVE: June 15, 2023

E7. SPECIAL ACCESS (A.K.A. BELLSOUTH SPA) SERVICE

E7.5 Rates and Charges (Cont'd)

E7.5.22 BellSouth Metro Ethernet Service (Cont'd)³

A. Rates and charges for month-to-month service (Cont'd)

13. Automatic Protection Switching (APS) Feature¹: Selected to provide automatic protection switching in conjunction with a Basic, Premium or Virtual BellSouth Metro Ethernet Connection of 10 Mbps or higher. Applicable APS rate element based upon type of APS selected and actual total route miles² (rounded up to next whole mile) based upon a customer-specific design as determined by the Telephone Company.

(a) Structural Protection

	Nonrecurring Charge	Month to Month	USOC
- Per APS Arrangement of less than 10 route miles	\$ 1000.00	\$ 2,565.00	MTEAO
- Per APS Arrangement of 10 through 25 route miles	1500.00	2,895.75	MTEA1
- Per APS Arrangement of greater than 25 through 35 route miles	2000.00	3,300.75	MTEA2
- Per APS Arrangement of greater than 35 through 50 route miles	2500.00	3,915.00	MTEA3

(b) Route Protection

- Per APS Arrangement of less than 10 route miles	1500.00	3,132.00	MTEA5
- Per APS Arrangement of 10 through 25 route miles	2000.00	3,523.50	MTEA6
- Per APS Arrangement of greater than 25 through 35 route miles	2500.00	4,002.75	MTEA7
- Per APS Arrangement of greater than 35 through 50 route miles	3000.00	4,637.25	MTEA8

14. Optical Termination Charge: An electrical termination on the customer premises is standard for 2, 4 and 8 Mbps Basic, Premium and Virtual Connections. Therefore, an Optical Termination Charge applies when an optional optical termination is requested and provided for a 2, 4 or 8 Mbps Connection.

(a) Per Optical Termination

- Per Connection	-	40.50	MTEO1
------------------	---	-------	-------

15. Service Reconfiguration Charge

(a) Per Request

- Per Connection	200.00	-	MTESR
------------------	--------	---	-------

16. System Reconfiguration Charge

(a) Per Request

- Per Connection	900.00	-	MTESY
------------------	--------	---	-------

Note 1: Optional feature only available with a Basic, Premium or Virtual Connection of 10 Mbps or higher. (APS is not available for a 2 Mbps, 4 Mbps or 8 Mbps Basic, Premium or Virtual Connection).

Note 2: Per definition of route mileage provided in E7.2.18U preceding.

Note 3: Effective on or after August 22, 2021, this Service will no longer be available for purchase by new or existing customers. In addition, requests to move, add, change, or renew existing service arrangements will not be accepted. Following the expiration of a customer's existing term agreement, service will be provided on a month-to-month basis at the applicable Monthly rates until the service is discontinued. The Company currently plans to discontinue this service on or after March 31, 2023.

(1)
 (1)
 (1)
 (1)

BELLSOUTH
 TELECOMMUNICATIONS
 FLORIDA
 ISSUED: August 20, 2021
 BY: Joe York, President -FL
 Jacksonville, Florida

ACCESS SERVICES TARIFF

Fourth Revised Page 81
 Cancels Third Revised Page 81

EFFECTIVE: August 22, 2021

E7. SPECIAL ACCESS (A.K.A. BELLSOUTH SPA) SERVICE

E7.5 Rates and Charges (Cont'd)

E7.5.22 BellSouth Metro Ethernet Service (Cont'd)¹

(C)

B. Rates and charges for Transport Payment Plan

1. Basic BellSouth Metro Ethernet Service Arrangements

(a) 2 Mbps Basic Connection

Transport Payment Plan Rates

	Nonrecurring Charge	Transport Payment Plan Rates			USOC
		A 12-36 Mos	B 37-60 Mos	C 61-96 Mos	
- Per Connection	\$ -	\$ 380.00	\$ 360.00	\$ 345.00	MTEBO
(b) 4 Mbps Basic Connection					
- Per Connection	-	500.00	415.00	395.00	MTEB1
(c) 8 Mbps Basic Connection					
- Per Connection	-	540.00	475.00	450.00	MTEB2
(d) 10 Mbps Basic Connection					
- Per Connection	-	630.00	599.00	550.00	MTEBA
(e) 100 Mbps Basic Connection					
- Per Connection	-	1,180.00	1,121.00	1,065.00	MTEBB
(f) 1 Gbps Basic Connection					
- Per Connection	-	2,565.00	2,437.00	2,315.00	MTEBC

2. Premium BellSouth Metro Ethernet Service Arrangements

(a) 2 Mbps Premium Connection					
- Per Connection, Fixed Mode	-	500.00	435.00	415.00	MTEPO
(b) 4 Mbps Premium Connection					
- Per Connection, Fixed Mode	-	540.00	470.00	445.00	MTEP1
(c) 8 Mbps Premium Connection					
- Per Connection, Fixed Mode	-	640.00	510.00	485.00	MTEP2
(d) 10 Mbps Premium Connection					
- Per Connection, Fixed Mode	-	720.00	684.00	650.00	MTEP3
- Per Connection, Burst Mode	-	900.00	855.00	812.00	MTEE3
(e) 20 Mbps Premium Connection					
- Per Connection, Fixed Mode	-	904.00	859.00	816.00	MTEP4
- Per Connection, Burst Mode	-	1,013.00	962.00	914.00	MTEE4
(f) 50 Mbps Premium Connection					
- Per Connection, Fixed Mode	-	1,192.00	1,132.00	1,075.00	MTEP5
- Per Connection, Burst Mode	-	1,238.00	1,176.00	1,117.00	MTEE5
(g) 100 Mbps Premium Connection					
- Per Connection, Fixed Mode	-	1,440.00	1,368.00	1,300.00	MTEP6
- Per Connection, Burst Mode	-	1,613.00	1,532.00	1,455.00	MTEE6
(h) 250 Mbps Premium Connection					
- Per Connection, Fixed Mode	-	1,800.00	1,710.00	1,625.00	MTEP7
- Per Connection, Burst Mode	-	1,935.00	1,838.00	1,746.00	MTEE7
(i) 500 Mbps Premium Connection					
- Per Connection, Fixed Mode	-	2,392.00	2,272.00	2,158.00	MTEP8
- Per Connection, Burst Mode	-	2,475.00	2,351.00	2,233.00	MTEE8
(j) 900 Mbps Premium Connection					
- Per Connection, Fixed Mode	-	3,700.00	3,532.00	3,356.00	MTEP9

3.

Note 1: Effective on or after August 22, 2021, this Service will no longer be available for purchase by new or existing customers. In addition, requests to move, add, change, or renew existing service arrangements will not be accepted. Following the expiration of a customer's existing term agreement, service will be provided on a month-to-month basis at the applicable Monthly rates until the service is discontinued. The Company currently plans to discontinue this service on or after March 31, 2023.

(N)
 |
 (N)

BELLSOUTH
 TELECOMMUNICATIONS
 FLORIDA
 ISSUED: August 20, 2021
 BY: Joe York, President -FL
 Jacksonville, Florida

ACCESS SERVICES TARIFF

Third Revised Page 81.1
 Cancels Second Revised Page 81.1

EFFECTIVE: August 22, 2021

E7. SPECIAL ACCESS (A.K.A. BELLSOUTH SPA) SERVICE

E7.5 Rates and Charges (Cont'd)

E7.5.22 BellSouth Metro Ethernet Service (Cont'd)²

(C)

B. Rates and charges for Transport Payment Plan (Cont'd)

4. Virtual BellSouth Metro Ethernet Service Arrangements¹

(a) 2 Mbps Virtual Connection

	Nonrecurring Charge	Transport Payment Plan Rates			USOC
		A 12-36 Mos	B 37-60 Mos	C 61-96 Mos	
- Per Connection	\$ -	\$ 340.00	\$ 321.00	\$ 305.00	MTEVO
(b) 4 Mbps Virtual Connection	-	380.00	359.00	341.00	MTEV1
- Per Connection	-	480.00	454.00	431.00	MTEV2
(c) 8 Mbps Virtual Connection	-	560.00	529.00	503.00	MTEV3
- Per Connection	-	744.00	703.00	668.00	MTEV4
(d) 10 Mbps Virtual Connection	-	1,032.00	975.00	926.00	MTEV5
- Per Connection	-	1,156.00	1,092.00	1,038.00	MTEV6
(e) 20 Mbps Virtual Connection	-	1,280.00	1,210.00	1,149.00	MTEV7
- Per Connection	-	1,640.00	1,550.00	1,472.00	MTEV8
(f) 50 Mbps Virtual Connection	-	1,936.00	1,830.00	1,738.00	MTEV9
- Per Connection	-	2,232.00	2,109.00	2,004.00	MTEVA
(g) 80 Mbps Virtual Connection	-	2,660.00	2,514.00	2,388.00	MTEVB
- Per Connection	-	3,104.00	2,933.00	2,787.00	MTEVC
(h) 100 Mbps Virtual Connection	-	3,540.00	3,345.00	3,178.00	MTEVD
- Per Connection	-				

5. BellSouth Metro Ethernet Service Independent Company (ICO) Trunk Arrangements

(a) ICO Trunk Connection	-	500.00	450.00	405.00	MTEGC
- Per VLAN Connection	-				

Note 1: Each Virtual Connection requires the establishment of a Class of Service (CoS) profile.

Note 2: Effective on or after August 22, 2021, this Service will no longer be available for purchase by new or existing customers. In addition, requests to move, add, change, or renew existing service arrangements will not be accepted. Following the expiration of a customer's existing term agreement, service will be provided on a month-to-month basis at the applicable Monthly rates until the service is discontinued. The Company currently plans to discontinue this service on or after March 31, 2023.

(N)
 |
 (N)

BELLSOUTH
 TELECOMMUNICATIONS
 FLORIDA
 ISSUED: August 20, 2021
 BY: Joe York, President -FL
 Jacksonville, Florida

ACCESS SERVICES TARIFF

Sixth Revised Page 82
 Cancels Fifth Revised Page 82

EFFECTIVE: August 22, 2021

E7. SPECIAL ACCESS (A.K.A. BELLSOUTH SPA) SERVICE

E7.5 Rates and Charges (Cont'd)

E7.5.22 BellSouth Metro Ethernet Service (Cont'd)¹

(C)

B. Rates and charges for Transport Payment Plan (Cont'd)

6. BellSouth Metro Ethernet Service Additional Mileage

- (a) BellSouth Metro Ethernet Service Additional Mileage:
 BellSouth Metro Ethernet Service arrangements greater than
 10 miles through 25 airline miles

	Nonrecurring Charge	Transport Payment Plan Rates			USOC
		A	B	C	
		12-36 Mos	37-60 Mos	61-96 Mos	
- Per 2 – 9 Mbps Connection	\$ -	\$ 320.00	\$ 320.00	\$ 320.00	MTEMO
- Per 10 – 99 Mbps Connection	-	333.00	333.00	333.00	MTEMA
- Per 100 – 499 Mbps Connection	-	414.00	414.00	414.00	MTEMB
- Per 500 Mbps – 1 Gbps Connection	-	504.00	504.00	504.00	MTEMC

- (b) BellSouth Metro Ethernet Service Additional Mileage:
 BellSouth Metro Ethernet Service arrangements greater than
 25 miles through 35 airline miles

- Per 2 – 9 Mbps Connection	-	525.00	525.00	525.00	MTEMD
- Per 10 – 99 Mbps Connection	-	558.00	558.00	558.00	MTEME
- Per 100 – 499 Mbps Connection	-	702.00	702.00	702.00	MTEMF
- Per 500 Mbps – 1 Gbps Connection	-	837.00	837.00	837.00	MTEMG

- (c) BellSouth Metro Ethernet Service Additional Mileage:
 BellSouth Metro Ethernet Service arrangements greater than
 35 miles through 50 airline miles

- Per 2 – 9 Mbps Connection	-	800.00	800.00	800.00	MTEMH
- Per 10 – 99 Mbps Connection	-	873.00	873.00	873.00	MTEMJ
- Per 100 – 499 Mbps Connection	-	1,089.00	1,089.00	1,089.00	MTEMK
- Per 500 Mbps – 1 Gbps Connection	-	1,314.00	1,314.00	1,314.00	MTEML

7. BellSouth Metro Ethernet Service Independent Company (ICO) Trunk Additional Mileage Charges

- (a) BellSouth Metro Ethernet Service ICO Trunk Additional Mileage:
 BellSouth Metro Ethernet Service ICO Trunk arrangements greater than
 10 miles through 25 airline miles
 - per VLAN Connection

-	170.00	170.00	170.00	MTEMI1
---	--------	--------	--------	--------

- (b) BellSouth Metro Ethernet Service ICO Trunk Additional Mileage:
 BellSouth Metro Ethernet Service ICO Trunk arrangements greater than
 25 miles through 35 airline miles
 - per VLAN Connection

-	420.00	420.00	420.00	MTEMI2
---	--------	--------	--------	--------

- (c) BellSouth Metro Ethernet Service ICO Trunk Additional Mileage:
 BellSouth Metro Ethernet Service ICO Trunk arrangements greater than
 35 miles through 50 airline miles
 - per VLAN Connection

-	675.00	675.00	675.00	MTEMI3
---	--------	--------	--------	--------

Note 1: Effective on or after August 22, 2021, this Service will no longer be available for purchase by new or existing customers. In addition, requests to move, add, change, or renew existing service arrangements will not be accepted. Following the expiration of a customer's existing term agreement, service will be provided on a month-to-month basis at the applicable Monthly rates until the service is discontinued. The Company currently plans to discontinue this service on or after March 31, 2023.

(N)
 |
 (N)

BELLSOUTH
 TELECOMMUNICATIONS
 FLORIDA
 ISSUED: August 20, 2021
 BY: Joe York, President -FL
 Jacksonville, Florida

ACCESS SERVICES TARIFF

Fifth Revised Page 83
 Cancels Fourth Revised Page 83

EFFECTIVE: August 22, 2021

E7. SPECIAL ACCESS (A.K.A. BELLSOUTH SPA) SERVICE

E7.5 Rates and Charges (Cont'd)

E7.5.22 BellSouth Metro Ethernet Service (Cont'd)⁴

(C)

B. Rates and charges for Transport Payment Plan (Cont'd)

8. Priority Plus Feature¹

	Transport Payment Plan Rates					
	A	B	C			
	12-36	37-60	61-96			
	Nonrecurring	Charge²	Mos	Mos	Mos	USOC
- Per Connection	\$ -	\$ 95.00	\$ 85.00	\$ 80.00		MTEQP

9. Q-Forwarding Feature¹

(a) Q-Forwarding Service Establishment Charge

- Per Connection	Nonrecurring Charge²	\$400.00		USOC
				MTEQF

(b) Q-Forwarding Network Assignment Charge

	Transport Payment Plan Rates					
	A	B	C			
	12-36	37-60	61-96			
	Nonrecurring	Charge²	Mos	Mos	Mos	USOC
- Per Network, Per Connection	\$ -	\$ 65.00	\$ 60.00	\$ 55.00		MTEQN

10. VLAN Aggregation Feature³

(a) VLAN Aggregation Service Establishment Charge

- Per Connection	Nonrecurring Charge²	\$400.00		USOC
				MTEQE

(b) VLAN Aggregation Network Assignment Charge

	Transport Payment Plan Rates					
	A	B	C			
	12-36	37-60	61-96			
	Nonrecurring	Charge²	Mos	Mos	Mos	USOC
- Per VLAN, Per Connection	\$ -	\$ 65.00	\$ 60.00	\$ 55.00		MTEQV

Note 1: Optional feature only available with a Premium Connection.

Note 2: This nonrecurring charge is applicable to service under a TPP arrangement.

Note 3: Optional feature only available with a Virtual Connection.

Note 4: Effective on or after August 22, 2021, this Service will no longer be available for purchase by new or existing customers. In addition, requests to move, add, change, or renew existing service arrangements will not be accepted. Following the expiration of a customer's existing term agreement, service will be provided on a month-to-month basis at the applicable Monthly rates until the service is discontinued. The Company currently plans to discontinue this service on or after March 31, 2023.

(N)
 |
 (N)

BELLSOUTH
 TELECOMMUNICATIONS
 FLORIDA
 ISSUED: August 20, 2021
 BY: Joe York, President -FL
 Jacksonville, Florida

ACCESS SERVICES TARIFF

Third Revised Page 83.1
 Cancels Second Revised Page 83.1

EFFECTIVE: August 22, 2021

E7. SPECIAL ACCESS (A.K.A. BELLSOUTH SPA) SERVICE

E7.5 Rates and Charges (Cont'd)

E7.5.22 BellSouth Metro Ethernet Service (Cont'd)³

(C)

B. Rates and charges for Transport Payment Plan (Cont'd)

II. CNM - Metro Ethernet Reporting Feature¹

- (a) CNM - Metro Ethernet Reporting, Service Establishment Charge

Nonrecurring Charge² **USOC**
 \$ 225.00 **MTERE**

- Per Customer Account

- (b) CNM - Metro Ethernet Reporting Charge

Transport Payment Plan Rates

	A	B	C	
Nonrecurring Charge²	12-36	37-60	61-96	USOC
\$ -	Mos	Mos	Mos	MTERC
- Per Connection	\$ 8.00	\$ 6.00	\$ 5.00	

- (c) CNM - Metro Ethernet Reporting, Web Interface Charge

- First - - - **MTER1**

- Each Additional **65.00** **18.00** **15.00** **13.00** **MTERW**

- (d) CNM - Metro Ethernet Reporting, Security Card

Nonrecurring Charge² **USOC**
 \$ 200.00 **MTERS**

- Each

Note 1: Optional feature only available with a Premium or Virtual Connection.

Note 2: This nonrecurring charge is applicable to service under a TPP arrangement.

Note 3: Effective on or after August 22, 2021, this Service will no longer be available for purchase by new or existing customers. In addition, requests to move, add, change, or renew existing service arrangements will not be accepted. Following the expiration of a customer's existing term agreement, service will be provided on a month-to-month basis at the applicable Monthly rates until the service is discontinued. The Company currently plans to discontinue this service on or after March 31, 2023.

(N)

(N)

BELLSOUTH
 TELECOMMUNICATIONS
 FLORIDA
 ISSUED: August 20, 2021
 BY: Joe York, President -FL
 Jacksonville, Florida

ACCESS SERVICES TARIFF

Second Revised Page 83.2
 Cancels First Revised Page 83.2

EFFECTIVE: August 22, 2021

E7. SPECIAL ACCESS (A.K.A. BELLSOUTH SPA) SERVICE

E7.5 Rates and Charges (Cont'd)

E7.5.22 BellSouth Metro Ethernet Service (Cont'd)⁴

(C)

B. Rates and charges for Transport Payment Plan (Cont'd)

12. Class of Service (CoS) Profile¹

(a) Real-Time CoS²

	Transport Payment Plan Rates				USOC
	Nonrecurring Charge ³	A	B	C	
		12-36 Mos	37-60 Mos	61-96 Mos	
- 10%	\$ -	\$ 54.00	\$ 54.00	\$ 54.00	MTETF
- 20%	-	108.00	108.00	108.00	MTETG
- 25%	-	135.00	135.00	135.00	MTETH
- 30%	-	162.00	162.00	162.00	MTETJ
- 35%	-	189.00	189.00	189.00	MTETK
- 40%	-	216.00	216.00	216.00	MTETL
- 50%	-	270.00	270.00	270.00	MTETM
- 70%	-	378.00	378.00	378.00	MTETO

(b) Interactive CoS²

- 10%	-	45.00	45.00	45.00	MTEVF
- 20%	-	90.00	90.00	90.00	MTEVG
- 25%	-	112.00	112.00	112.00	MTEVH
- 30%	-	135.00	135.00	135.00	MTEVJ
- 35%	-	157.00	157.00	157.00	MTEVK
- 40%	-	180.00	180.00	180.00	MTEVL
- 50%	-	225.00	225.00	225.00	MTEVM

Note 1: Each Virtual Connection requires the designation of a CoS profile with desired percentages of each CoS selected. The sum of the percentages for all CoS selected for a Virtual Connection must sum to 100%..

Note 2: The combined CoS bandwidth percentages selected in a customer's Virtual Connection CoS profile for Real-Time CoS plus Interactive CoS may not exceed 50%, except where the customer selects the 70% Real-Time CoS bandwidth percentage and has no Interactive traffic.

Note 3: This nonrecurring charge is applicable to service under a TPP Arrangement.

Note 4: Effective on or after August 22, 2021, this Service will no longer be available for purchase by new or existing customers. In addition, requests to move, add, change, or renew existing service arrangements will not be accepted. Following the expiration of a customer's existing term agreement, service will be provided on a month-to-month basis at the applicable Monthly rates until the service is discontinued. The Company currently plans to discontinue this service on or after March 31, 2023.

(N)

(N)

BELLSOUTH
TELECOMMUNICATIONS
FLORIDA

ACCESS SERVICES TARIFF

Second Revised Page 83.3
Cancels First Revised Page 83.3

ISSUED: August 20, 2021
BY: Joe York, President -FL
Jacksonville, Florida

EFFECTIVE: August 22, 2021

E7. SPECIAL ACCESS (A.K.A. BELLSOUTH SPA) SERVICE

E7.5 Rates and Charges (Cont'd)

E7.5.22 BellSouth Metro Ethernet Service (Cont'd)³

(C)

B. Rates and charges for Transport Payment Plan (Cont'd)

12. Class of Service (CoS) Profile¹ (Cont'd)

(c) Business Critical CoS

	Transport Payment Plan Rates				USOC
	Nonrecurring Charge ²	A	B	C	
		12-36 Mos	37-60 Mos	61-96 Mos	
- 10%	\$ -	\$ 27.00	\$ 27.00	\$ 27.00	MTEPF
- 20%	-	54.00	54.00	54.00	MTEPG
- 25%	-	67.00	67.00	67.00	MTEPH
- 30%	-	81.00	81.00	81.00	MTEPJ
- 35%	-	94.00	94.00	94.00	MTEPK
- 40%	-	108.00	108.00	108.00	MTEPL
- 50%	-	135.00	135.00	135.00	MTEPM
- 60%	-	162.00	162.00	162.00	MTEPN
- 75%	-	202.00	202.00	202.00	MTEPP
- 90%	-	243.00	243.00	243.00	MTEPQ
- 100%	-	270.00	270.00	270.00	MTEPR

(d) Best Effort CoS

- 10%	-	9.00	9.00	9.00	MTEBF
- 20%	-	18.00	18.00	18.00	MTEBG
- 25%	-	22.00	22.00	22.00	MTEBH
- 30%	-	27.00	27.00	27.00	MTEBJ
- 35%	-	31.00	31.00	31.00	MTEBK
- 40%	-	36.00	36.00	36.00	MTEBL
- 50%	-	45.00	45.00	45.00	MTEBM
- 60%	-	54.00	54.00	54.00	MTEBN
- 75%	-	67.00	67.00	67.00	MTEBP
- 90%	-	81.00	81.00	81.00	MTEBQ

Note 1: Each Virtual Connection requires the designation of a CoS profile with desired percentages of each CoS selected. The sum of the percentages for all CoS selected for a Virtual Connection must sum to 100%..

Note 2: This nonrecurring charge is applicable to service under a TPP Arrangement.

Note 3: Effective on or after August 22, 2021, this Service will no longer be available for purchase by new or existing customers. In addition, requests to move, add, change, or renew existing service arrangements will not be accepted. Following the expiration of a customer's existing term agreement, service will be provided on a month-to-month basis at the applicable Monthly rates until the service is discontinued. The Company currently plans to discontinue this service on or after March 31, 2023.

(N)
|
(N)

BELLSOUTH
 TELECOMMUNICATIONS
 FLORIDA
 ISSUED: August 20, 2021
 BY: Joe York, President -FL
 Jacksonville, Florida

ACCESS SERVICES TARIFF

Fourth Revised Page 84
 Cancels Third Revised Page 84

EFFECTIVE: August 22, 2021

E7. SPECIAL ACCESS (A.K.A. BELLSOUTH SPA) SERVICE

E7.5 Rates and Charges (Cont'd)

E7.5.22 BellSouth Metro Ethernet Service (Cont'd)⁴

(C)

B. Rates and charges for Transport Payment Plan (Cont'd)

13. Automatic Protection Switching (APS) Feature¹: Selected to provide automatic protection switching in conjunction with a Basic, Premium or Virtual BellSouth Metro Ethernet Connection of 10 Mbps or higher. Applicable APS rate element based upon type of APS selected and actual total route miles² (rounded up to next whole mile) based upon a customer-specific design as determined by the Telephone Company.

(a) Structural Protection

	Transport Payment Plan Rates				USOC
	Nonrecurring Charge³	A 12-36 Mos	B 37-60 Mos	C 61-96 Mos	
- Per APS Arrangement of less than 10 route miles	\$ -	\$ 1250.00	\$ 1092.00	\$ 935.00	MTEAO
- Per APS Arrangement of 10 through 25 route miles	-	1496.00	1301.00	1126.00	MTEA1
- Per APS Arrangement of greater than 25 through 35 route miles	-	1798.00	1679.00	1530.00	MTEA2
- Per APS Arrangement of greater than 35 through 50 route miles	-	2452.00	2376.00	2134.00	MTEA3

(b) Route Protection

- Per APS Arrangement of less than 10 route miles	-	1470.00	1285.00	1100.00	MTEA5
- Per APS Arrangement of 10 through 25 route miles	-	1760.00	1530.00	1325.00	MTEA6
- Per APS Arrangement of greater than 25 through 35 route miles	-	2115.00	1975.00	1800.00	MTEA7
- Per APS Arrangement of greater than 35 through 50 route miles	-	2885.00	2795.00	2510.00	MTEA8

14. Optical Termination Charge: An electrical termination on the customer premises is standard for 2, 4 and 8 Mbps Basic, Premium and Virtual Connections. Therefore, an Optical Termination Charge applies when an optional optical termination is requested and provided for a 2, 4 or 8 Mbps Connection.

(a) Per Optical Termination

- Per Connection	-	30.00	30.00	30.00	MTEO1
------------------	---	-------	-------	-------	-------

15. Service Reconfiguration Charge

(a) Per Request

- Per Connection			Nonrecurring Charge³	USOC
			\$ 200.00	MTESR

16. System Reconfiguration Charge

(a) Per Request

- Per Connection			900.00	MTESY
------------------	--	--	---------------	--------------

Note 1: Optional feature only available with a Basic, Premium or Virtual Connection.

Note 2: Per definition of route mileage provided in E7.2.18U preceding.

Note 3: This nonrecurring charge is applicable to service under a TPP arrangement.

Note 4: Effective on or after August 22, 2021, this Service will no longer be available for purchase by new or existing customers. In addition, requests to move, add, change, or renew existing service arrangements will not be accepted. Following the expiration of a customer's existing term agreement, service will be provided on a month-to-month basis at the applicable Monthly rates until the service is discontinued. The Company currently plans to discontinue this service on or after March 31, 2023.

(N)

(N)

BELLSOUTH
TELECOMMUNICATIONS
FLORIDA
ISSUED: June 29, 2021
BY: Joe York, President -FL
Jacksonville, Florida

ACCESS SERVICES TARIFF

Third Revised Page 1.1
Cancels Second Revised Page 1.1

EFFECTIVE: June 30, 2021

E7. DEDICATED ACCESS SERVICES**E7.1 General**

Dedicated Access Services provide a transmission path to directly connect an IC terminal location in a LATA to the End User's premises¹; two IC terminal locations; an IC terminal location and a HUB; or a HUB and an End User's premises. Dedicated Access Services include all exchange access not utilizing Company end office switches. This type of Access Service is used, for example, by IC's for the provision of private line service. When the Company incurs costs as a result of an IC generated activity, defined as the relocation of an IC POP, Dedicated Access Services nonrecurring charges will be billed to the IC. Prorating of high capacity services among End Users will not be allowed.

The connections provided by Dedicated Access Services can be either analog or digital. Analog connections are differentiated by spectrum and bandwidth. Digital connections are differentiated by bit rate.

E7.1.1 Channel Types

There are six types of channels used to provide Dedicated Access Services. Each type has its own characteristics. All are subdivided by one or more of the following:

- Transmission specifications
- Bandwidth
- Speed (i.e., bit rate)
- Spectrum

Customers can order a basic channel and select from a list of available transmission parameters and channel interfaces, that they desire to meet specific communications requirements.

For purposes of ordering channels, each has been identified as a type of Dedicated Access Service. However, such identification is not intended to limit a customer's use of the channel, nor to imply that the channel is limited to a particular use.

Following is a brief description of each type of channel:

1. Telegraph Grade² (a.k.a. BellSouth SPA Telegraph) (TG) - a channel for the transmission of binary signals at rates of 0 to 75 baud or 0 to 150 baud. (C)
2. Voice Grade² (a.k.a. BellSouth SPA DS0 VG) (VG) - a channel for the transmission of analog signals within an approximate bandwidth of 300-3000 Hz. (C)
3. **(DELETED)**
4. Digital Data Access² (a.k.a. BellSouth SPA DS0 Digital Data) Service (DDAS) - a channel for the digital transmission of synchronous serial data at rates of 2.4, 4.8, 9.6, 19.2, 56.0 or 64.0 Kbps. (C)
5. High Capacity (a.k.a. BellSouth SPA High Capacity) (HC) - a channel for the transmission of isochronous serial digital data at rates of 1.544, 3.152, 6.312, or 44.736 Mbps.
6. Derived Data Channel² (a.k.a. BellSouth SPA Derived Data Channel) - a digital data channel derived from a two-wire local exchange facility that transmits voice and data signals simultaneously. (C)

Note 1: Company Centrex CO-like switches and other Company CO derived services are considered to be End User's premises for purposes of this Tariff.

Note 2: Effective June 30, 2021, this Service will no longer be available for purchase by new or existing customers. In addition, requests to move, add, change, or renew existing service arrangements will not be accepted. Following the expiration of a customer's existing term agreement, service will be provided on a month-to-month basis at the applicable Monthly rates until the service is discontinued. The Company currently plans to discontinue this service on or after June 30, 2024.

(N)
|
(N)